

BOROSIL[®] Scientific

Borosil Scientific Limited

enabling the future of science

MANUFACTURERS OF

LABORATORY GLASSWARE | EQUIPMENT | ANALYTICAL VIALS | PROCESS SYSTEMS
PHARMACEUTICAL PRIMARY GLASS PACKAGING



**PRODUCT
CATALOGUE**
PRICE LIST 2024-25
1st APRIL 2024



BOROSIL[®]
enabling the future of science

**BOROSIL
KLASSPACK[®]**
pharmaceutical packaging

LABQUEST[®]
BOROSIL

BOROSIL[®]
PROCESS SCIENCES

gocl[®]
The Transparent Specialist
A BOROSIL SCIENTIFIC Company

MISSION & VISION

Our mission is to emerge as the preferred vendor for laboratory glassware and to develop a complementary range of products for the laboratory.

To enjoy this fascinating journey while enhancing marketing capabilities, continuously improving our quality and services and investing in our people while being socially responsible and yielding profits for our stakeholders.

Leading by Vision

Message from our MD and CEO



Shreevar Kheruka

Managing Director & Chief Executive Officer

Borosil Limited

Our vision at Borosil has been driven by a singular thought – to be the most customer centric company in India.

Our customers are our biggest strength. We have been the preferred speciality glass of choice for the scientific community for over 62 years and we are proud to have been working closely with scientific professionals and industry experts in their pursuit of discovery.

India's growth story is a beacon of light in the midst of global uncertainty. Our young and dynamic demography is helping us deliver world leading growth. Moreover, these factors are likely to remain consistent for the next 2 decades at the very least. We, at Borosil, are incredibly excited about the journey ahead. We believe that science will play a significant role in the nation building process over the next 20 years. We must be self reliant in the areas of pharmaceutical, biotech, food, energy, general industry as well as defence.

With all this in mind, it brings me immense joy to announce the establishment of a new company, Borosil Scientific Ltd. This company has been established keeping in mind the needs of the scientific community in India. We are committed to helping our customers deliver value in their respective fields by offering products that are world leading in terms of quality with service that is available at your doorstep at short notice. These products include our core viz. laboratory glassware, but expanding rapidly into the areas of laboratory instrumentation, process chemistry as well as pharmaceutical packaging.

I extend my sincere appreciation to our dedicated team and invaluable stakeholders. Your unwavering support and collective efforts will keep propelling us forward.

Corporate Values



Integrity

- We conduct our business sincerely and fairly, with honesty and transparency
- We hold ourselves to the same high standards we set for others
- We uphold the values of Borosil in every action and decision
- We abide by the highest standards of ethics in all our financial dealings regardless of the amounts involved
- We stick to our values even in the most difficult of circumstances
- Judgement & decisions are taken on the basis of facts & figures not based on perception



Customer Focus

- Our customer (external as well as internal) is at the center of our actions
- We build long term relations with our customers
- We focus our attention on those activities that bring value addition to our customers
- We strive to understand our customers' needs proactively and meet these needs on time
- We provide value for money to our customers



Respect

- We give honest and constructive feedback to help people achieve their full potential
- We are on time and prepared for our appointments and meetings
- We treat/ deal with every individual with utmost dignity, empathy and professionally
- We encourage team work and never hesitate to give credit to others
- We actively & empathetically listen to others and respect their views, irrespective of their levels and / or other abilities
- Our decisions are always neutral & data based and not person based



Continual Improvement

- We believe in continuous quality improvements in our products and processes through innovation and team work
- We strive to understand internal and external benchmarks and improvise to reach them
- We challenge accepted ways of doing things and suggest new approaches
- We make efforts to understand new trends in the market place and introduce innovative products / services to capture these trends
- We are committed to learning and bringing new ideas to the table



Accountability

- We take ownership of our decisions and hold ourselves accountable for both successes and failures
- We find alternative paths to success rather than waiting for direction
- We speak up even if it is not the majority view
- We do what is best for the company rather than function or for self
- We focus on outcomes and results rather than activity
- We fulfill all commitments made to colleagues and customers



Safety

- We value human life and our bodies more than profits
- We follow practices that continuously reduce risk of loss of human life or property

The **BOROSIL** Group

Science & Industrial Products Division



Borosil's Scientific Limited offers an entire gamut of the finest quality scientific and laboratory glassware, laboratory instruments and primary pharmaceutical packaging. Borosil Technologies Limited located at Hinjewadi, Pune is a 100% owned subsidiary of Borosil Limited which is mandated to develop Laboratory equipments under Labquest brand. Borosil Klass Pack Ltd., a subsidiary of Borosil Limited, is one of India's leading manufacturers of Glass Ampoules and Tubular Glass Vials of USP Type 1 that are widely used as primary packaging materials by pharmaceutical companies for their life-saving drugs. We also manufacture a wide portfolio of Chromatography vials. Borosil Process Sciences, a recent introduction in the portfolio provides sophisticated offerings for chemical synthesis & process development from bench top reactors to complex pilot plants with programmable controls. This range of over 3000 products from glassware, equipment and pharma packaging finds application across diverse disciplines such as Quality Control in pharmaceutical industries, research institutes, food and soil testing, microbiology, biotechnology, agriculture and many more. Newest introduction Symbolising quality, accuracy and dependability since six decades, Borosil has earned the trust and unwavering loyalty of leading pharmaceutical companies and R&D laboratories, as well as scientific, health and educational institutions.

Consumer Division



For over half a century, Borosil has stood as the premier brand for heat-resistant glassware in India, epitomizing quality and durability. Recognized as the trusted choice among consumers nationwide, Borosil represents much more than just glassware. The brand has broadened its portfolio to include Larah Opal Glass dinner sets, kitchen appliances, Insulated Flasks & bottles, Cookware and pressure cookers, storage solutions, and even glass lunch boxes, that resonate to the everyday needs of today's consumers.

Borosil's expansion into small appliances has been particularly noteworthy. The brand now offers a wide array of products including Juicer Mixer Grinders, Hand Mixers, Oven Toaster Grills, Toasters, Blenders, and Rice Cookers. Each appliance is supported by Borosil's extensive nationwide customer service network, ensuring that help is always within reach, minimizing any inconvenience.

At Borosil, the pillars of quality and trust are paramount. We are dedicated to going above and beyond to ensure that our products not only meet but exceed expectations, performing beautifully across all uses. Explore our comprehensive product range at www.myborosil.com and discover how we can make every day better for you.

Solar Division



Borosil Renewables Ltd. is the first solar glass manufacturer in India and is part of the 'Borosil Group, which has been engaged in manufacturing a wide range of consumer-ware products and scientific and laboratory glassware for over five decades. Our state-of-the-art manufacturing facility is spread over around 100 acres in Bharuch, Gujarat, with a solar glass production and processing capacity of 1000 TPD, equivalent to 6.5 GW per annum. Recently, Borosil Renewables Ltd. acquired Europe's largest manufacturer of solar glass, the Interfloat Group, which consists of Glass Manufacturing Brandenburg (GMB), located in Tschernitz, Germany, and Interfloat Corporation, based in Liechtenstein. GMB operates a solar glass plant with a production capacity of 350 TPD (tonnes per day). With this acquisition, BRL's solar glass capacity has grown to 1350 TPD. The company has a strong focus on innovation and is known for its pioneering achievements like the development of the World's First fully tempered 2 MM thick solar glass, solar glass with the lowest iron content, giving the highest glass efficiency, and being the first company in the World to successfully be able to remove an extremely hazardous substance, "antimony," from its solar glass, etc. The company has products like Selene, an anti-glare solar glass suitable for PV installations near airports, and Shakti, a very high-efficiency solar glass in a matt-matt finish.

BOROSIL[®] **Scientific** Quality Policy

We, at Borosil Scientific Limited, are committed to understanding our customer's needs and fulfilling the same on time every time.

By bringing the voice of our customers inside the organization, we strive to be our customers' #1 preferred brand.

We are committed to achieving the highest level of customer satisfaction through improvements in quality of our products & services.

We believe in continual improvements and innovation in our business and manufacturing processes. We strive to ensure that our team achieves the highest quality output in the most efficient manner possible.

This will be achieved by our total commitment to:

- Communication with our customers to understand their needs
- Continuously updating our technical competence, systems and processes
- Enhancing the expertise of our people by periodic training & reviews
- Preserving our corporate values

This policy will be available to all interested parties where appropriate.

Date: 01.01.2024



Vinayak Patankar
Whole time Director & Chief Executive Officer

Leading by Vision

Message from our CEO



Vinayak Patankar

Whole Time Director & Chief Executive Officer

Borosil Scientific Limited

Borosil's legacy is a testament to our commitment towards excellence and the trust placed in us by our customers.

The emergence of Borosil Scientific marks a substantial milestone for us. We aspire to be pioneers in offering reliable, high-quality and affordable tools that empower scientific industries, contributing to build a self-reliant nation.

We are driven by the belief that science holds the key to progress. At Borosil Scientific, we see ourselves as facilitators in this exploration. As a homegrown manufacturer from India our mission is to empower the scientific community by developing superior quality products that are safe, dependable and yet affordable.

The BSL team is poised and ready to set new benchmarks. By making the best scientific tools which are accessible to all laboratories in India and across the globe, we are making a sincere effort to contribute to the growth of industries and, in turn, build a self-reliant nation where collective progress thrives.

Together, let us make a significant impact and create a pathway towards the future of science.

A Legacy of more than 6 decades...

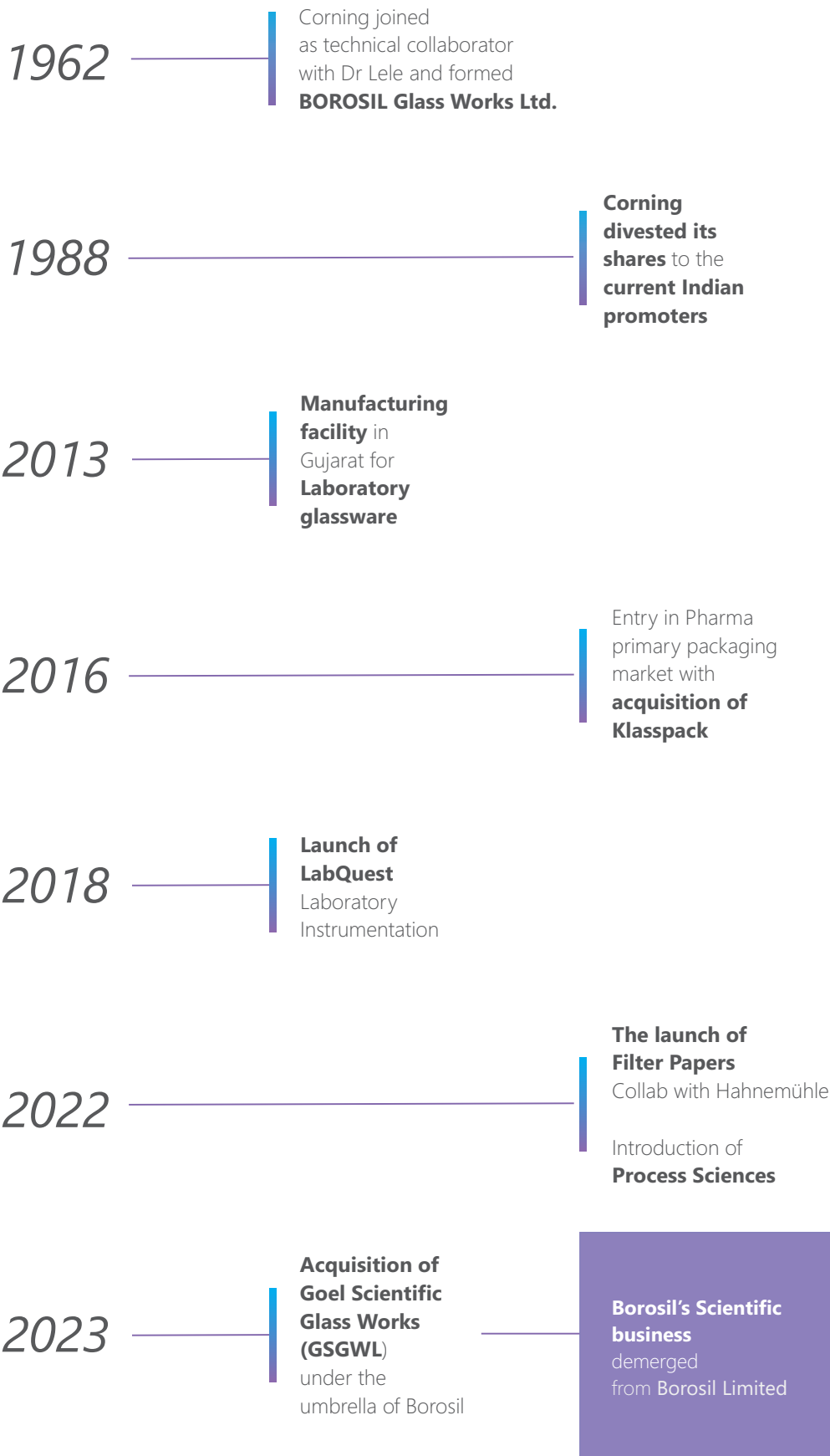

About us

BOROSIL[®] Scientific

Borosil Scientific Limited



In Dec 2023, the scientific business of Borosil Ltd demerged to form Borosil Scientific Limited which now comprises Laboratory instrumentation, Pharmaceutical Primary packaging, Process systems, in addition to the laboratory glassware and consumables.

Our Purpose

We are driven by the belief that science holds the key to progress. As a homegrown manufacturer from India our mission is to empower the scientific community by developing superior quality products that are safe, dependable and yet affordable.

By making the best scientific tools which are accessible to all laboratories in India and across the globe, we are making a sincere effort to contribute to the growth of industries and, in turn, build a self-reliant nation where collective progress thrives.

60+

Years of experience

4000+

SKUs spanning over 4 verticals

5

Manufacturing locations in India

4

Warehouses PAN India

150+

Channel partners PAN India

Laboratory Consumables

For conducting experiments
with safety



86,064 sq ft production floor

Manufacture 10,000 units per day

700 skilled glass blowers

80,000 sq ft warehouse

- Laboratory Glassware
- Analytical Vials
- Filtration assembly & consumables
- Lab Accessories

Laboratory Equipment

Affordable & dependable
choice for accurate results



36,000 sq ft state-of-the art mfg facility

120+ design engineers &
manufacturing professionals

Inhouse application lab

Dedicated team of 15+ Service engineers

- Nutrition & Environment
- Lab Essentials
- Life Sciences
- Liquid Handling

BOROSIL[®] Scientific



LABQUEST BY BOROSIL[®]



Pharmaceutical Primary Packaging

Safe, reliable & supporting
healthcare industry



Installed Capacity

- Glass Ampoules Over
810 Million PA
- Tubular Glass Vials Over
350 Million PA

400+ Skilled Manufacturing professionals

- Tubular Glass Vials
- Glass Ampoules

BOROSIL
KLASSPACK[®]
pharmaceutical packaging



Process Equipment

Enabling chemical research at
an affordable cost



23,415 sq ft state-of-the art mfg
facility

Team of 350+ skilled professionals

- Lab Reactor
- Industrial Reactors
- Lab Rotary Evaporators
- Industrial Rotary Evaporator

goel[®]
The Transparent Specialist

A BOROSIL SCIENTIFIC Company



Borosil Scientific Expands with Acquisition of Goel Scientific Glassworks Ltd



A BOROSIL SCIENTIFIC Company



Borosil Scientific successfully acquired Goel Scientific Glass Works Limited (GSGWL) in April 2023, marking a significant milestone in our journey.

GSGWL specializes in manufacturing glass industrial process systems, catering to the pharmaceutical, chemical and defense industries. Renowned as a global leader in crafting intricate and large glass articles with volumes of up to 500 Liters, GSGWL is at the forefront of innovation in these dynamic sectors.

The pharmaceutical, chemical, and defense industries are currently witnessing substantial growth in their research and development endeavors, with process systems playing a pivotal role. By incorporating GSGWL's expertise and products into our portfolio, BSL is well-positioned to meet the evolving needs of our customers with top-notch solutions. This strategic move also aligns with our commitment towards import substitution in this crucial area.

This acquisition not only expands our product offerings but also reflects our dedication to provide world-class products that cater to the diverse requirements of our customers.



WHY BOROSIL

1 Laboratory glassware

- Three out of four glassware articles used in laboratories across India are Borosil branded
- Over 6 decades of trust

Certifications

- Certified for ISO 9001:2015 quality management system for Scientific Laboratory Glassware & Laboratory Equipment / Instrument
- NABL ISO/IEC :17025, 2017 accredited laboratory
- Represents India on ISO/TC 48 – Technical committee for laboratory glassware and apparatus

Quality and Compliance

- Advanced computer controlled machines for calibration
- Laser sensing of meniscus and real-time image of meniscus provided on calibration certificate
- Compliance to international standards ISO/DIN/ASTM for dimensions and tolerances

Infrastructure

- State-of-the-art blowing facility having 700+ skilled blowers
- Equipped with automated blank manufacturing machines
- Annealing process by unique Lehr technology
- Advanced laser machines for laser marking of LIMS compatible QR code and UID code

Unmatched Service Levels

- Network of 150 Channel Partners PAN India
- 4 warehouses across the country
- 96% of the time same day delivery
- Team of 80+ sales ambassadors PAN India
- Customer-centric approach

Certifications

Certified for ISO 9001: 2015 Quality Management System, DIN EN ISO 14001: 2015 Environmental Management System and DIN ISO 45001: 2018 Occupational Health & Safety Management System for Scientific Laboratory Glassware & Laboratory Equipment



ISO/TC 48



We take the pride to mention that **BOROSIL** represents India on **ISO/TC 48 - Technical Committee for Laboratory equipment and apparatus.**

NABL Accredited Testing Laboratory

Operated by trained and certified lab technicians



BOROSIL offers a range of glassware certified as per NABL norms

Volumetric Flasks

Measuring Cylinders

Burettes

Volumetric & Graduated
Pipettes

NABL Accreditation
Certificate

NABL Product
Certificate

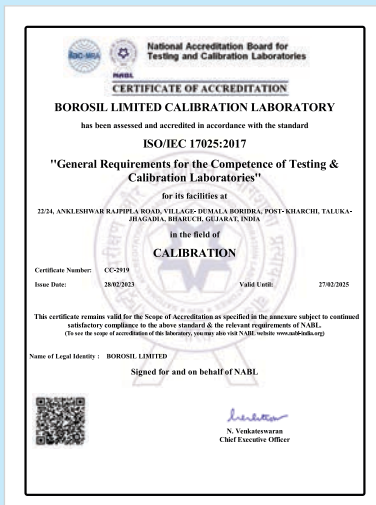

- Product details
- Calibration details
- Calibration Equipment traceability
- Statement for recalibration

**NEW
VERSION
IS LIVE**

Update the BOROSIL app now!

TWO EASY OPTIONS

TO DOWNLOAD THE CERTIFICATE

SCAN
QR CODE



ENTER
UID CODE

Individual calibration certificate

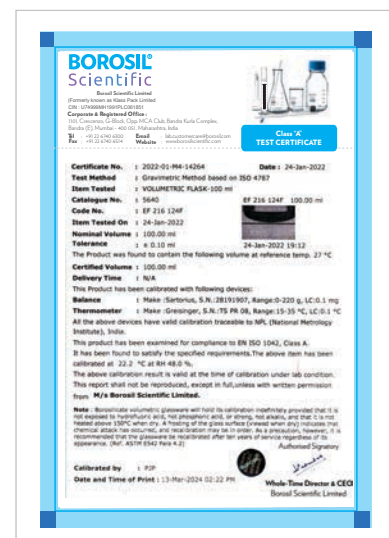

Individual Calibration Certificate can also be accessed
at www.borosil.com

Factory and Production

Automatic Blank Manufacturing Facility

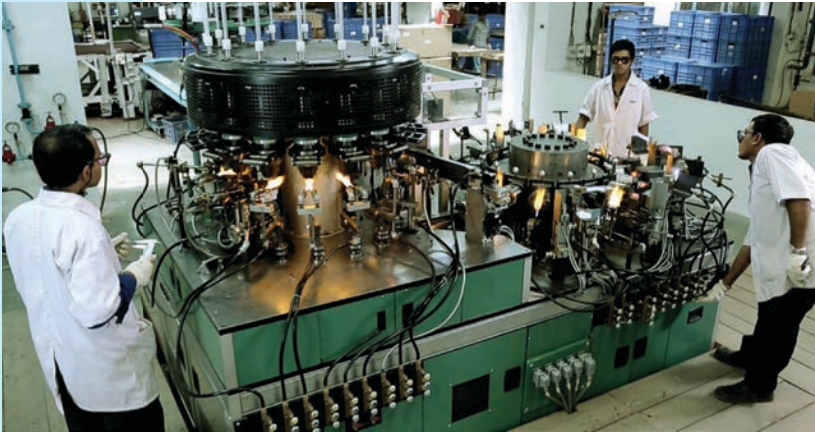

State-of-art auto blowing facility used to produce blanks with uniform wall thickness and ensure exact shape and dimension according to the standards.

All the blanks are manufactured from 3.3 Low Expansion Borosilicate Glass with controlled Internal Diameter tubing.

Unique Annealing Facility



All **Borosil** glassware products pass through annealing Lehr chamber where the stresses are eliminated under controlled heating and cooling process

This annealing process ensures the long lasting printing quality. In order to get the highest level of precision, carefully controlled gradual heating and cooling procedures are essential

Petri Dish Manufacturing Facility



Advanced Printing Technology



High definition printing for accurate and easy reading

Wall Thickness Measure



Automated Vial Forming Machine



Calibration Process



BOROSIL Scientific

is India's single largest manufacturer of a complete range of Volumetric Glassware. Borosil's Volumetric products are used in all laboratories from high-end pharmaceutical production companies to high schools and colleges.



ACCURACY

- Computer Controlled Calibration
- Reliability in experiments through individually certified volumetric glassware
- Facilitates audit procedures in the laboratory
- Enhanced production from new facility

BOROSIL Scientific

adheres to the highest quality standards, right from the raw material used to the measurement and calibration of the finished product. Visual and physical quality checks are undertaken at each stage of production, in order to ensure the highest quality product for customers.



MECHANICAL STRENGTH

- Optimum wall thickness
- Annealed glassware imparts better mechanical strength
- Ideal for vacuum application, wet and dry sterilization
- Harder, hence lasts longer

BOROSIL Scientific

ensures that every Volumetric Glassware product is of the highest quality in the following parameters:



THERMAL SHOCK RESISTANCE

- Safely withstands thermal shock
- Annealed to remove residual thermal Stress
- Thinner, uniform wall, hence lasts longer



CHEMICAL DURABILITY

- High resistance to attack from acids, salt solutions and organic solvents
- Low alkalinity, hence less leaching
- Low alkalinity makes glass harder, hence the glass lasts longer



ISO/IEC 17025:2005 Accredited. Calibration Laboratory
Computer controlled automatic calibration machine with optical laser beams to prevent human error and ensure highest level of accuracy and precision

BOROSIL Scientific performs the calibration process with fully automatic state-of-the-art calibration machines that eliminate any possibility of human error. This also ensures a high degree of repeatable measurements for all Borosil Volumetric products.

BOROSIL Scientific has an in-house set-up of a well-equipped temperature-controlled calibration laboratory with precision electronic balances, thermometers and stopwatches that are traceable to national standards. Calibration of Volumetric Glassware is entrusted to only trained and experienced technicians.

The following steps are carried out by highly precise, fully automated computer-controlled machines:

1. Filling the Volumetric blanks with a precisely- defined amount of de-mineralized water under controlled temperature.
2. The meniscus is determined with a laser-controlled camera at the exact lowest point of the water level, and the calibration mark is made with a fine diamond wheel. This gives accuracies that cannot be achieved by manual calibration.
3. Cylinders, Burettes and Pipettes are marked at a minimum of two calibration points.
4. The wet surface area factor is always taken into account, throughout the process.
5. The calibration laboratory is temperature, light controlled and temperature is maintained at $23^{\circ}\text{C} \pm 2^{\circ}\text{C}$.

All Volumetric Glassware is calibrated either as

To contain TC / In

The contained quantity of liquid corresponds exactly to the capacity indicated on the article (e.g. graduated cylinders and volumetric flasks).

To deliver TD / Ex

The delivered quantity of liquid corresponds exactly to the capacity indicated on the article. (e.g. pipette and burettes).

These steps ensure that each and every Volumetric product leaving the **BOROSIL Scientific** facility meets the highest international standards and can be used for various purposes with the highest degree of repeatability and accuracy.



Microscope Slide & Cover Glass Production Line

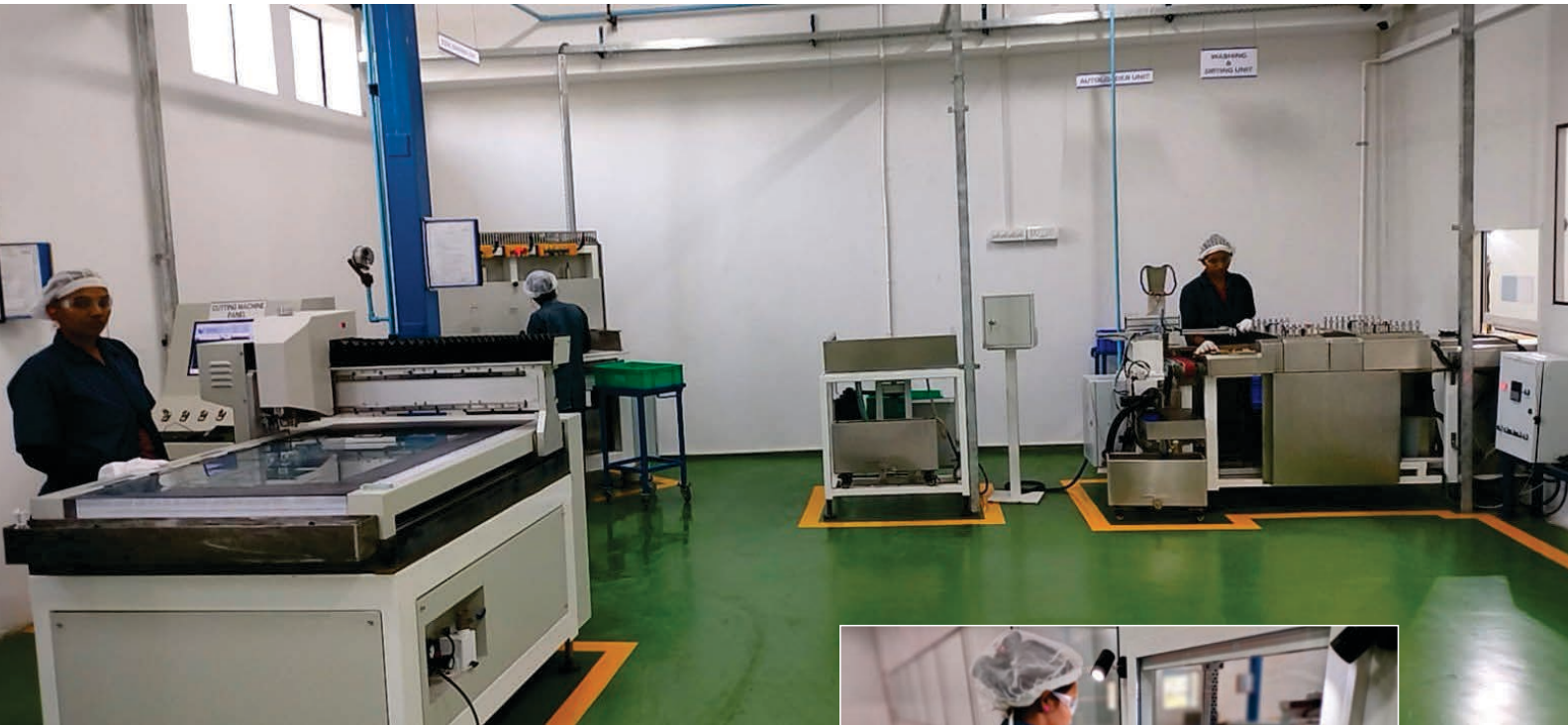

State-of-the-art facility set up for manufacturing microscope slides at Bharuch factory. The slides are made using best quality raw material and comply with ISO 8037 Standard.



New Warehouse in Bharuch, Gujarat, India



We are pleased to announce the opening of our new warehouse in Bharuch which was inaugurated by our esteemed Chairman Mr. Pradeep Kheruka, MD Mr. Shreevar Kheruka and COO Mr. Vinayak Patankar on 8th September 2022.

The event marked a new chapter in scaling up our operations with a thought provoking address by AVP - Operations Mr. Jeevan Dogra.

With a new, advanced and bigger facility, this new warehouse is equipped with state of the art safety features. Equipped with the latest facilities, this warehouse is tuned to cater to our expanding global operations.



"A local Global" with exports to 90+ Countries

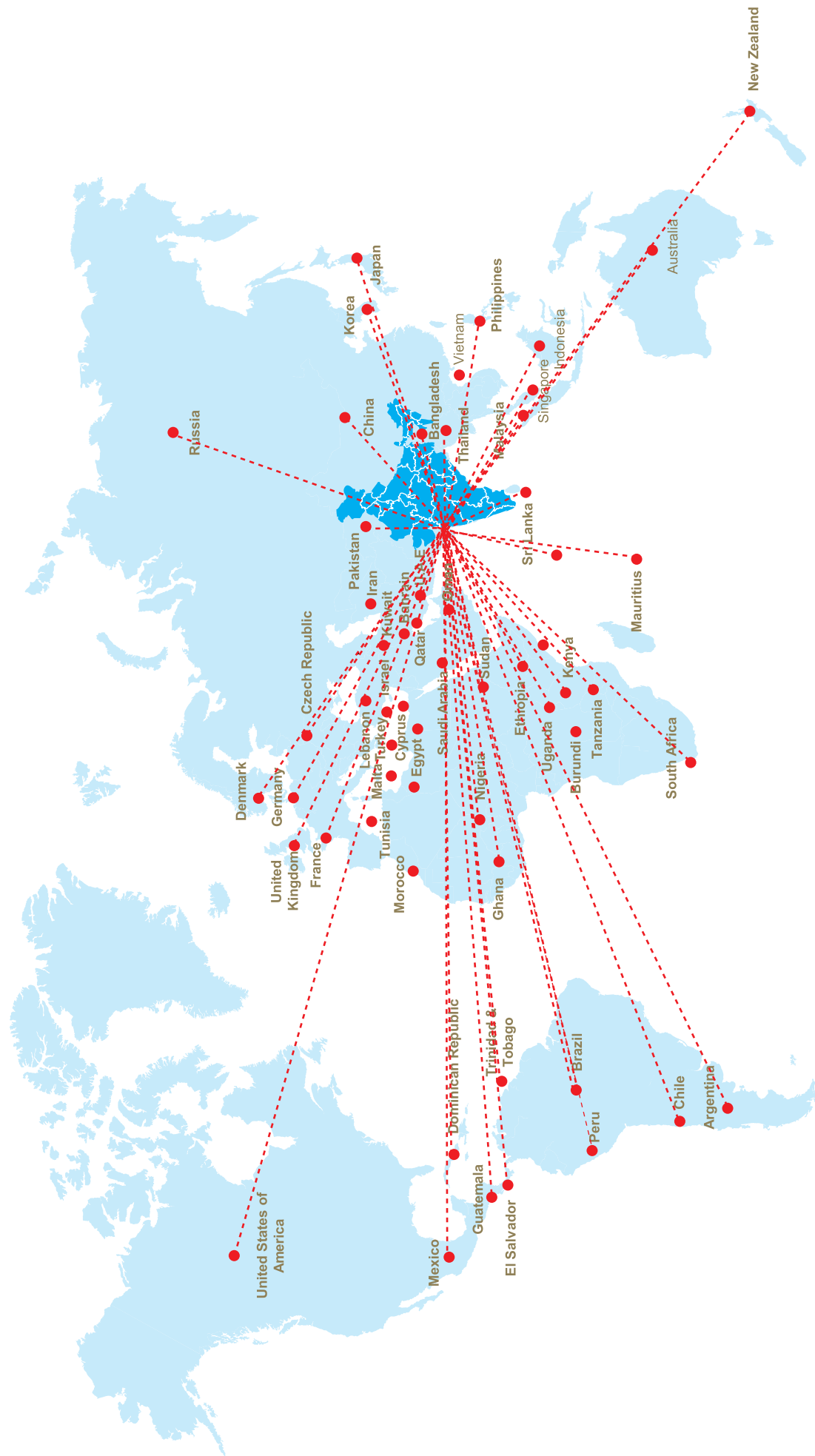

"Industry leading distribution network"

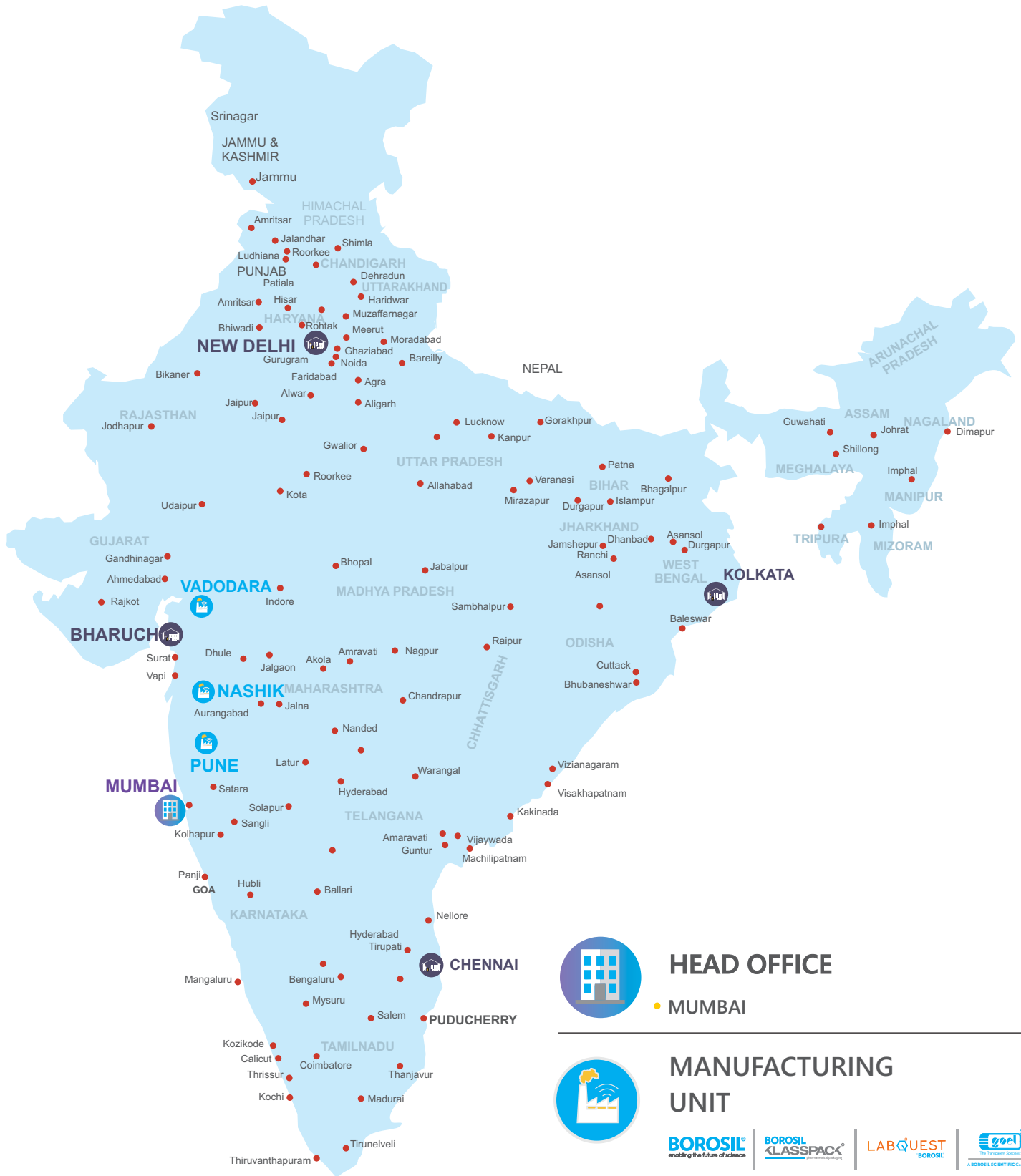

 **HEAD OFFICE**

- MUMBAI

 **MANUFACTURING UNIT**

BOROSIL
enabling the future of science

BOROSIL CLASSPACK
enabling the future of science

LABQUEST
BOROSIL

The Science Specialist
A BOROSIL SCIENTIFIC Company

 **WAREHOUSES**

- BHARUCH
- DELHI
- CHENNAI
- KOLKATA

 **PAN INDIA NETWORK OF 150 CHANNEL PARTNERS**



Ecologically Responsible

Rain water harvesting has been deployed in our 110 acre facility in Gujarat, since 2003.

Wind energy is the source of 48% of all the electricity that we consume.

Our Borosolar water heating systems are used to heat the water supplied in all Borosil Guesthouses and Colonies..

Our other energy efficient measures include advanced waste heat recovery systems and solar lighting.

Our in-house 9 hole par 36 Golf Course is maintained by using the water from our rain water harvesting initiative.

WE nurture

Borosil supports and runs a school, for children from neighbouring villages and employees' children.

Borosil proposes to open a hospital in the near future.



WE care

Borosil supports GLOBAL PARLI - A Mission to Transform India Through Rural Economic Transformation



4.1 Mn+
Fruit Trees Planted Till February 2021



**AWARDS
&
ACCOLADES**

**EY Entrepreneur Of The Year -
Manufacturing award for 2022**



Mr. Pradeep Kheruka, Chairman Borosil Ltd accepted the award from Mr Hardeep Singh Puri, Minister of Petroleum and Natural Gas of India

**Borosil Group Clinches Prestigious
Capexil Export Awards for FY 2021-22**



Mr. Vinayak Patankar, WTD & CEO BSL and Mr Ashok Jain, Director BRL, accepted the award from Mr Om Birla, Hon speaker, Lok Sabha, Govt of India. Minister of Petroleum and Natural Gas of India



Gold Award in Innovative category by CII in 47th Kaizen Competition



Gold Award in Kaizen category by QCFCI in Annual Convention On Quality Concepts



Certificate of Zed Bronze by Ministry of Micro, Small & Medium Enterprises under MSME Sustainable (ZED) Certification scheme



Special Award for Indigenization of advanced processes and machinery by IRIM in India Green Manufacturing Challenge Award



Gold Award in by QCFCI in Annual Convention on Quality Concepts



Silver Medal by IRIM in National Award for Manufacturing Competitiveness

Foreword

Borosil Scientific Limited presents to you, this Scientific and Laboratory Glassware Pricelist. Unless, specific arrangements have been made to the contrary, the prices contained in this Pricelist are applicable to all goods despatched on or after **April 01, 2024**.

This Pricelist supersedes all previous prices. All prices stated herein are the recommended maximum price per piece in INR, and are exclusive of All Taxes, Goods and Services Tax (GST), any delivery charges, other statutory and non statutory levies. The dealers are at liberty to charge prices lower than those stipulated them.

Customised Glassware

We undertake the manufacture of special glassware to agreed specifications. Please send us your queries at the address below, including complete details of specifications, and drawings wherever possible. We would be pleased to assist you in formulating specifications within normal working tolerances. Usually, we only accept orders with a minimum ex-works value of INR 10,000/-

Corporate Office :

Borosil Scientific Limited

Crescenzo, G-Block, Opp. MCA Club,

Bandra Kurla Complex,

Bandra (E), Mumbai - 400 051, India

Tel : 022 - 6740 6300

Fax : 022 - 6740 6514

Email : lab.customercare@borosil.com / bsl@borosil.com

Conditions of Sale

At Borosil Scientific, it is our policy to market our laboratory glassware through our wide network of Authorised Dealers. Strategically located all over India, they are best equipped to satisfy the Individual requirements of users across the nation. The products supplied will usually be in accordance with illustration and description however, **Borosil Scientific reserves the right to make alterations and modifications depending upon circumstances and /or changes in official specifications, or as a result of design improvements.**

Although the products are guaranteed for glass quality and workmanship. Borosil shall not be liable for any loss or damage or injury, arising directly or indirectly from the use of these products.

The images given in the Pricelist are for reference purpose only.
Actual products may differ from the images.

Beaker
26 - 28

Bottles
30 - 45

Burettes
46 - 58

Cones
60 - 61

Condensers
62 - 64

Cylinders
66 - 73

Desiccators
74 - 75

Dishes
76 - 78

Distilling
Apparatus
80 - 83

Water
Distillation Unit
84 - 89

Survismeter
& Viscometer
90 - 91

Extractors
92 - 95

Flasks
96 - 118

Filtration
Products
120 - 133

Volumetric
Flask & Columns
136 - 148

Funnels
150 - 153

Cones
154-155

Gas Generator
156

Jars &
Kettles
156 - 157

Pipettes
156 - 168

Weighing
Scoop
170

Mortar and
Pestle
170

Tubes
171 - 174

Adapters
175 - 184

Test Tubes, Stirrer Rod
Culture Tubes
186 - 192

Watch
Glasses
193

Sintered Ware
194 - 197

Quartz Ware
198 - 203

Slides &
Cover Glasses
204 - 205

Vials
206 - 217

Lab
Accessories
218 - 225

Laboratory
Filter Media
226 - 241

Nutrition &
Environment
244 - 264

Lab
Essentials
265 - 294

Life Sciences
295 - 317

Liquid Handling
Systems
318 - 326

Tips & MCT
328 - 331

index

- Beakers
- Bottles
- Burettes
- Cones

- Condensers
- Cylinders
- Desiccators

- Dishes
- Distilling Apparatus
- Water Distilling Unit
- Survismeter & Viscometer

- Extraction Apparatus
- Flasks
- Filtration Products

- Volumetric Flasks
- Funnels
- Gas Generator
- Jars & Kettles

- Pipettes
- Weighing Scoop
- Tubes

- Adapters
- Test Tubes
- Sintered Ware
- Quartz Ware

- Slides & Cover Glasses
- Vials
- Lab Accessories
- Filter Media

- Laboratory Equipment
- Liquid Handling Systems
- Tips & MCT
- Process Sciences

Beakers

Whether it is research, industry or education, the Beaker has a wide range of applications. This simple container, used for stirring and mixing liquids, is also ideal for heating them. Controlled wall thickness at the sides, radius and the base, ensures a fine balance between the thermal resistance and mechanism strength, to enable effective heating. Many Beakers also have a spout that makes pouring easier and more precise.

BOROSIL Scientific Glassware are best-in-class products with several advantages. They have a high level of thermal shock resistance and a high operating temperature. Besides using USP type I borosilicate glass constant quality control checks are conducted throughout the production process to ensure uniformity of the wall thickness. Such uniform wall thickness distribution prevents uneven expansion and stressing of the glass that often results in a failure.

Beakers are mainly used as heating vessels. The tall-shape design of the Beaker is ideal for heating in a liquid bath, especially when the contents need to be kept distinctly apart from the surrounding medium or materials,

BOROSIL Scientific brand Low Form Beaker (Cat. No. 1000) and **BOROSIL Scientific** brand Tall Form Beaker (Cat. No. 1060) are two popular styles used for storage and mixing.

BOROSIL Scientific offers full range of beakers to suit every applications.



Made from 3.3 Low Expansion
Borosilicate Glass



1000 - LOW FORM BEAKER

With Spout

- Complies with IS 2619 /ISO 3819 and DIN 12331
- The spout design enables clean and precise pouring
- Graduated to indicate the approximate content
- Uniform wall thickness distribution improves mechanical & thermal properties & makes it ideal for heating liquids
- The easy-to-read scale and large labelling field makes marking easier
- High resistance to chemical attack

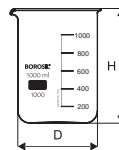

Product Code	Capacity ml	Approx O.D. x Height mm	Quantity Per Case	Price / Piece ₹
1000005	5*	22 x 30	20	150.00
1000006	10*	26 x 35	20	150.00
1000009	25	34 x 50	60	150.00
1000D12	50	42 x 60	60	105.00
1000D16	100	50 x 70	40	105.00
1000D18	150	60 x 80	40	105.00
1000D21	250	70 x 95	40	115.00
1000D23	400	80 x 110	40	185.00
1000D24	500	83 x 115	40	180.00
1000D25	600	90 x 125	40	250.00
1000D28	800	100 x 135	20	365.00
1000D29	1000	105 x 145	20	365.00
1000D30	2000	130 x 185	6	745.00
1000D31	3000	150 x 210	4	2005.00
1000D33	5000	170 x 270	4	2940.00
1000D38	10000	220 x 350	1	9445.00

* 5 ml and 10 ml Beakers are not graduated.

1040 - TALL FORM BEAKER

Without Spout

- Complies with IS 2619 / ISO 3819 and DIN 12331
- Graduated to indicate the approximate content
- Uniform wall thickness distribution improves mechanical & thermal properties & makes it ideal for heating liquids
- The easy-to-read scale and large labelling field makes marking easier
- High resistance to chemical attack
- Ideal for titrations

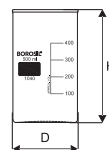

Product Code	Capacity ml	Approx O.D. x Height mm	Quantity Per Case	Price / Piece ₹
1040012	50	38 x 70	40	155.00
1040016	100	50 x 80	40	160.00
1040018	150	54 x 95	40	165.00
1040021	250	60 x 120	40	175.00
1040024	500	80 x 140	20	250.00
1040025	600	80 x 150	20	325.00
1040028	800	90 x 175	20	400.00
1040029	1000	95 x 180	20	485.00

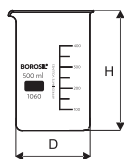

1060 - TALL FORM BEAKER With Spout

- Complies with IS 2619 / EN ISO 3819 and DIN 12331
- Graduated to indicate the approximate content
- The spout design enables clean and precise pouring
- Uniform wall thickness distribution improves mechanical & thermal properties & makes it ideal for heating liquids
- The easy-to-read scale and large labelling field makes marking easier
- High resistance to chemical attack
- Ideal for titrations

Product Code	Capacity ml	Approx O.D. x Height mm	Quantity Per Case	Price / Piece ₹
1060012	50	38 x 70	40	185.00
1060D16	100	50 x 80	40	190.00
1060018	150	54 x 95	40	195.00
1060D21	250	60 x 120	40	190.00
1060D24	500	80 x 140	20	260.00
1060025	600	80 x 150	20	410.00
1060028	800	90 x 175	20	480.00
1060D29	1000	95 x 180	20	520.00

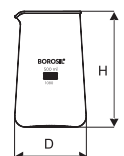

1080 - PHILLIP (CONICAL) BEAKER With Spout

- Conical shape (Phillips pattern) with spout
- Its mouth is smaller in diameter than its base
- The Phillips Beaker is ideal for measuring, containment, mixing and decanting

Product Code	Capacity ml	Approx O.D. x Height mm	Quantity Per Case	Price / Piece ₹
1080021	250	68 x 110	40	840.00
1080024	500	88 x 145	40	1050.00

BOROSIL®
Scientific

Tongs For Beakers & Flasks

- Made of stainless steel
- Used to handle hot beakers
- Provided with silicon sleeves or in fibre glass yarn to resist direct flame



For more details please refer page no. 219

Stirring Revolution in India



A hot plate magnetic Stirrer is an essential part of almost every laboratory.

Labs in India had to either rely on expensive imported hot plate stirrers or compromise by opting for crude fabricated stirrers with almost no safety features.

Introducing the HLS200 from Borosil that is stirring revolution in India. With segment first features that allows experiments to be controlled precisely by regulating the actual media temperature.

Call or Write to us to be part of the revolution!

Email id: lab.support@borosil.com
Toll Free Number: 1800 224 551



Reagent Bottles



BOROSIL Scientific Laboratory bottles are chemically resistant and stable. When fitted with pouring ring, dripping can be totally eliminated. As there is only one size of screw thread for all bottles from 100 ml onwards, the screw caps and pouring rings are fully interchangeable. The bottles, pouring rings and caps are autoclavable and sterilizable.

For AMBER Bottles, ambering is done on the external surface only, hence properties within the bottle remain unchanged. It protects the media from light radiations of wavelengths between 300nm and 500 nm.

Made from 3.3 Low Expansion Borosilicate Glass



1220 - ASPIRATOR BOTTLES

With Tubulation and PP Cap

- Complies with IS 1388 (Part III), ISO 4796-3
- Supplied with GL45 screw caps and pouring ring made of polypropylene, autoclavable at 121°C
- All sizes have a durable matt-finished enamelled area for marking
- Suitable for storage of aggressive media

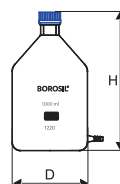

Product Code	Capacity ml	Approx O.D. x Height* mm	Thread Specification	Quantity Per Case	Price / Piece ₹
1220021	250**	70 x 140	GL 45	10	515.00
1220024	500**	86 x 176	GL 45	10	595.00
1220029	1000	101 x 225	GL 45	10	1045.00
1220030	2000	136 x 260	GL 45	5	1660.00
1220033	5000	181 x 320	GL 45	1	9535.00
1220038	10000***	235 x 405	GL 45	1	16140.00
1220040	20000***	296 x 505	GL 45	1	29335.00

**Not covered in ISO / DIN standards.

*Height indicated is of Bottle only

***As per Borosil Scientific dimension



1240 - ASPIRATOR BOTTLES

With Socket Outlet For Stopcock and PP Cap

- Complies with IS 1388 (Part III), ISO 4796-3
- Supplied with GL45 screw caps and pouring ring made of polypropylene, autoclavable at 121°C
- All sizes have a durable matt-finished enamelled area for marking
- Suitable for storage of aggressive media



Product Code	Capacity ml	Approx O.D. x Height* mm	Thread Specification	Outlet Ground Joint Size	Quantity Per Case	Price / Piece ₹
1240029	1000	101 x 225	GL 45	19 / 26	10	1295.00
1240030	2000	136 x 260	GL 45	19 / 26	5	1855.00
1240033	5000	181 x 330	GL 45	29 / 32	1	10735.00
1240038	10000***	235 x 410	GL 45	29 / 32	1	15210.00
1240040	20000***	296 x 505	GL 45	29 / 32	1	26145.00

*Height indicated is of Bottle only

***As per Borosil Scientific dimension

Glass stopcock available on request





1245 - ASPIRATOR BOTTLES With I/C Glass Stopcock and PP Cap

- Complies with IS 1388 (Part III), ISO 4796-3
- Supplied with GL45 screw caps and pouring ring made of polypropylene, autoclavable at 121°C
- All sizes have a durable matt-finished enamelled area for marking
- Suitable for storage of aggressive media

Product Code	Capacity ml	Approx O.D. x Height* mm	Thread Specification	Outlet Ground Joint Size	Quantity Per Case	Price / Piece ₹
1245029	1000	101 x 225	GL 45	19 / 26	10	3600.00
1245030	2000	136 x 260	GL 45	19 / 26	4	4250.00
1245033	5000	181 x 330	GL 45	29 / 32	1	14085.00
1245038	10000***	235 x 410	GL 45	29 / 32	1	19855.00
1245040	20000***	296 x 505	GL 45	29 / 32	1	29495.00

*Height indicated is of Bottle only

***As per Borosil Scientific dimension

Spare glass stopcock available on request



1250 - B.O.D. BOTTLES

- Complies with IS 9213
- Supplied with Interchangeable glass stopper and plastic cap
- Individual number printed on the bottle
- Used for determination of Biological Oxygen Demand in industrial effluents, waste and water

Product Code	Capacity ml	Approx O. D. x Height* mm	Quantity Per Case	Price / Piece ₹
1250013	60**	42 x 100	10	565.00
1250017	125**	55 x 120	10	700.00
1250022	300	70 x 143	30	815.00

*Height indicated is of Bottle only

**60 & 125 ml are not covered in standards

300 ml is for determination of B.O.D. in Industrial effluents, wastes and water as per method specified by the American Public Health Association



1290 - ROUX BOTTLES WITH OFF SET NECK

- Complies with IS 6942
- The off-set neck is tool-finished for greater strength and uniform stopper fit
- Withstands repeated sterilisation cycles (wet or dry)
- These bottles facilitate the growing of mass cultures and monolayer cultures

Product Code	Capacity ml	Approx B x W x H mm	Approx Neck I. D. mm	Quantity Per Case	Price / Piece ₹
1290029	1000	126 x 56 x 265	25	20	2270.00

1500 - REAGENT BOTTLES

Narrow Mouth With I/C Glass Stopper

- Complies with IS 1388 (Part II), ISO 4796 - 2
- Supplied with solid glass stopper
- Printed with graduations using a durable white enamel
- Bottles are mechanically strong and chemical resistant with a sturdy ground neck

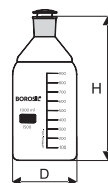

Product Code	Capacity ml	Approx O.D. x Height* mm	Neck Stopper Size	Quantity Per Case	Price / Piece ₹
1500013	60**	45 x 90	14 / 23	20	450.00
1500016	100	56 x 100	19 / 26	10	495.00
1500017	125**	56 x 120	19 / 26	20	445.00
1500021	250	70 x 138	19 / 26	10	490.00
1500024	500	86 x 177	24 / 29	10	495.00
1500029	1000	101 x 225	29 / 32	5	865.00
1500030	2000	136 x 260	34 / 35	5	1460.00

*Height indicated is of Bottle only

**60 & 125 ml is not covered in standards



1501 - REAGENT BOTTLES

Narrow Mouth With Screw Cap

- Complies with IS 1388 (Part I), ISO 4796 - 1
- Supplied with screw caps and pouring ring made of polypropylene, autoclavable at 121°C
- Printed with graduations and retrace code using a durable white enamel
- 100 ml to 20000 ml Bottles have uniform GL 45 thread
- Mechanically strong and chemical resistant
- Ideal for storage of chemicals, reagents, media



Product Code	Capacity ml	Approx O.D. x Height* mm	Thread Specification	Quantity Per Case	Price / Piece ₹
1501006	10**#	36 x 50	GL 25	10	570.00
1501009	25#	36 x 70	GL 25	20	380.00
1501012	50	46 x 87	GL 32	20	465.00
1501016	100	56 x 100	GL 45	10	415.00
1501018	150**#	60 x 120	GL 45	10	490.00
1501021	250	70 x 138	GL 45	10	420.00
1501024	500	86 x 177	GL 45	10	465.00
1501029	1000	101 x 225	GL 45	10	715.00
1501030	2000	136 x 260	GL 45	10	1275.00
1501031	3000**	158 x 295	GL 45	2	6600.00
1501033	5000***	181 x 320	GL 45	1	7450.00
1501038	10000***	235 x 405	GL 45	1	12295.00
1501040	20000***	296 x 505	GL 45	1	22990.00

- *Height indicated is of Bottle only

- #Without Pouring Ring

- **Not covered in any standard

- ***As per Borosil Scientific Dimension



BOROSIL[®]
Scientific

Premium Grade Bottles

Made for Pharmaceutical and
Bio Pharmaceuticals applications

*Ideal for storage, transfer and transport of formulations, APIs,
bulk drugs and biopharma products*

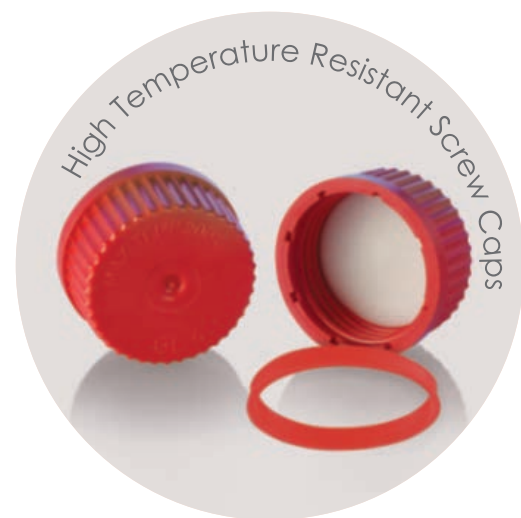

- Manufactured from 3.3 Borosilicate glass complying to USP, ASTM and ISO standards
- Meets the quality requirements of international pharmacopoeias
- Designed to meet the regulatory requirements of storage containers
- A reliable choice of bottle to fulfil the increasingly tighter regulations of pharma and biotech industries

Still stuck with the old method for transferring HPLC solvents ?



BOROSIL[®]
Scientific
is right here with a solution

PROUDLY MADE IN 
india

Multi-Port HPLC Cap with Anti-twist mechanism

*A smart solution for transfer of
HPLC mobile phase solvents*

Unique air valve cum filter
0.1µm filter prevents contamination of solvents with dust particles and the release of solvent vapours thereby maintaining the solvent concentration

PP fittings for different tubing ODs
Supplied with three connectors – for 3.2 mm and 1.6 mm OD tubing alongwith one end plug

Polypropylene Cap
Suitable for all types of GL 45 bottles and autoclavable at 121°C

Anti-twist mechanism
Freely rotatable PTFE manifold prevents twisting of the tubes while opening and closing the cap

Product Code	No of Ports	Neck	Quantity per Pack
1513C04	4	GL45	4 Nos
1513C02	2	GL45	4 Nos
1513C01	1	GL45	4 Nos



1503 - SCREW CAPS FOR BOTTLES

- Made of polypropylene (PP)
- Supplied with PP pouring rings
- Autoclavable at 121°C
- Available in 5 different colours

Product Code	Colour Description	Thread Specification	Quantity Per Case	Price / Piece ₹
1503C01	Blue	GL 45	10	110.00
1503C02	Orange	GL 45	10	115.00
1503C03	Yellow	GL 45	10	115.00
1503C04	Green	GL 45	10	115.00
1503C05	Grey	GL 45	10	115.00
1503C06	Blue	GL 25*	10	105.00
1503C07	Blue	GL 32*	10	105.00
1503C08	Blue	GL 36*	10	105.00

HSN Code: 39235010

Without pouring ring



1505 - HIGH TEMPERATURE RESISTANT SCREW CAPS

- Made of Polybutylene Terephthalate (PBT)
- Supplied with a silicone/PTFE liner and pouring ring
- Temperature resistance: - 40°C to +200°C
- Withstand sterilization conditions: hot air sterilization in oven upto 200°C and steam sterilization in autoclave at 121°C

Product Code	Colour Specification	Thread Specification	Quantity Per Case	Price / Piece ₹
1505C01	Red	GL - 45	10	835.00

HSN Code: 39235010

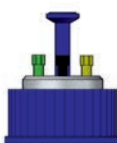

1513 - MULTI-PORT HPLC CAP For HPLC Solvent Transfer



- Polypropylene Cap Suitable for all types of GL 45 bottles and
- Autoclavable at 121°C
- PP fittings for different tubing ODs Supplied with three connectors
- Anti-twist mechanism Freely rotatable
- Unique air valve cum filter

Product Code	No of Ports	Neck	Quantity Per Case	Price / Piece ₹
1513C04	4	GL 45	4	3755.00
1513C02	2	GL 45	4	3635.00
1513C01	1	GL 45	4	3465.00

1506 - REAGENT BOTTLES

Wide Mouth With Screw Cap, Square

- Supplied with GL80 screw caps and pouring ring made of polypropylene, autoclavable at 121°C
- Square shape enables stacking of bottles during usage, storage and transport
- Extra wide GL 80 neck gives ease of pouring & filling of liquids as well as powders
- Large stable base helps prevent tumbling of the bottle
- Ideal for storage and transfer of pharma and biopharma products

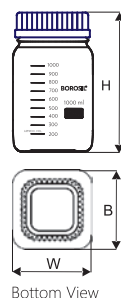

Product Code	Capacity ml	Approx B x W x H mm	Thread Specification Approx O.D. mm	Quantity Per Case	Price / Piece ₹
1506024	500	94 x 94 x 141	GL-80	10	1215.00
1506029	1000	105 x 105 x 187	GL-80	10	1345.00
1506030	2000	115 x 115 x 260	GL-80	10	2115.00
1506033	5000	160 x 160 x 357	GL-80	1	13045.00

*Height indicated is of Bottle only

1507 - REAGENT BOTTLES

Wide Mouth with Screw Cap, Square, Amber

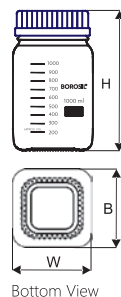

Product Code	Capacity ml	Approx B x W x H mm	Thread Specification Approx O.D. mm	Quantity Per Case	Price / Piece ₹
1507024	500	94 x 94 x 141	GL-80	10	1645.00
1507029	1000	105 x 105 x 187	GL-80	10	1820.00
1507030	2000	115 x 115 x 260	GL-80	10	2860.00
1507033	5000	160 x 160 x 357	GL-80	1	17615.00

*Height indicated is of Bottle only

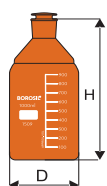

1509 - REAGENT BOTTLES

Narrow Mouth With I/C Glass Stopper, Amber

- Complies with IS 1388 (Part II), ISO 4796 - 2
- Supplied with solid glass stopper
- Printed with graduations using a durable white enamel
- Bottles are mechanically strong and chemical resistant with a sturdy ground neck
- Uniform amber colour protects media from light radiation with a wave-length between 300 nm and 500 nm
- Ideal for use with light-sensitive media and for the long-term storage of substances

Product Code	Capacity ml	Approx O.D. x Height* mm	Neck Stopper Size	Quantity Per Case	Price / Piece ₹
1509013	60**	45 x 100	14 / 23	20	645.00
1509016	100	56 x 100	14 / 23	10	715.00
1509017	125**	56 x 120	19 / 26	20	675.00
1509021	250	70 x 138	19 / 26	10	845.00
1509024	500	86 x 177	24 / 29	10	985.00
1509029	1000	101 x 225	29 / 32	5	1275.00
1509030	2000	136 x 260	34 / 35	5	2350.00

*Height indicated is of Bottle only

**60 & 125 ml is not covered in standards

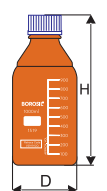

1519 - REAGENT BOTTLES

Narrow Mouth With Screw Cap, Amber

- Complies with IS 1388 (Part I), ISO 4796 - 1
- Supplied with screw caps and pouring ring made of polypropylene, autoclavable at 121°C
- Printed with graduations and retrace code using a durable white enamel
- 100 ml to 20000 ml Bottles have uniform GL 45 thread
- Mechanically strong and chemical resistant
- Uniform amber colour protects media from light radiation with a wave-length between 300 nm and 500 nm
- Ideal for use with light-sensitive media and for the long-term storage of substances

Product Code	Capacity ml	Approx O.D. x Height* mm	Thread Specification	Quantity Per Case	Price / Piece ₹
1519006	10**#	36 x 50	GL 25	10	705.00
1519009	25#	36 x 70	GL 25	20	595.00
1519012	50#	46 x 87	GL 32	20	690.00
1519016	100	56 x 100	GL 45	10	715.00
1519021	250	70 x 138	GL 45	10	750.00
1519024	500	86 x 177	GL 45	10	900.00
1519029	1000	101 x 225	GL 45	10	1175.00
1519030	2000	136 x 260	GL 45	10	2205.00
1519031	3000**	158 x 295	GL 45	2	11770.00
1519033	5000***	183 x 320	GL 45	1	12150.00
1519038	10000***	235 x 405	GL 45	1	17685.00
1519040	20000***	296 x 500	GL 45	1	31975.00

- *Height indicated is of Bottle only

#Without Pouring rings

**Not covered in any standard

***As per BOROSIL Scientific dimensions

1585 - SOLUTION BOTTLES

With Tooled Neck

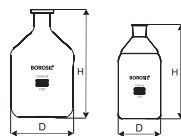

- Complies with IS 1388 (Part II), ISO 4796 - 2
- 10, 20 & 50 litre bottles specially designed for handling and storing culture media
- All sizes have a durable matt-finished enamelled area for marking

Product Code	Capacity ml	Approx O.D. x Height mm	Approx Neck I. D. mm	Quantity Per Case	Price / Piece ₹
1585021	250	70 x 145	18	20	485.00
1585024	500	86 x 180	23	20	520.00
1585029	1000	101 x 230	28	10	820.00
1585030	2000	136 x 255	33	10	1390.00
1585031	3000	158 x 255	44	4	6910.00
1585033	5000	183 x 330	44	1	8505.00
1585038	10000*	235 x 430	54	1	14540.00
1585040	20000*	296 x 530	54	1	24135.00
1585046	50000*	417 x 665	89	1	114755.00

*As per Borosil Scientific dimensions



1589 - SOLUTION BOTTLES

With Tooled Neck, Amber



- Complies with IS 1388 (Part II), ISO 4796 - 2
- 10, 20 & 50 litre bottles specially designed for handling and storing culture media
- All sizes have a durable matt-finished enamelled area for marking
- Uniform amber colour protects media from light radiation with a wave-length between 300 nm and 500 nm
- Ideal for use with light-sensitive media and for the long-term storage of substances

Product Code	Capacity ml	Approx O.D. x Height mm	Approx Neck I. D. mm	Quantity Per Case	Price / Piece ₹
1589021	250	70 x 145	18	10	885.00
1589024	500	86 x 180	23	20	920.00
1589029	1000	101 x 230	28	5	1345.00
1589030	2000	136 x 255	33	5	2320.00
1589031	3000	158 x 255	44	4	9930.00
1589033	5000	183 x 330	44	1	11110.00
1589038	10000*	235 x 430	54	1	19630.00
1589040	20000*	296 x 530	54	1	31535.00

*As per Borosil Scientific dimensions



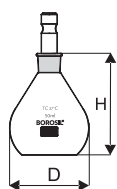

1624 - RELATIVE DENSITY BOTTLES (Pyknometer) With I/C PTFE Stopper With Certificate

- Supplied with I/C PTFE (Teflon) stopper
- These bottles are mechanically strong and chemical resistant
- All sizes have a durable matt-finished enamelled area for marking
- Provided with certificate

Product Code	Capacity ml	Capacity Tolerance \pm ml	Max. Body Dia x Height mm	Size of Inter-Changeable Stopper	Quantity Per Case	Price / Piece ₹
1624006	10	0.3	29 x 48	10 / 15	5	1315.00
1624009	25	0.8	40 x 55	10 / 15	5	1550.00
1624012	50	1	50 x 65	10 / 15	5	1635.00

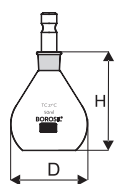

1625 - RELATIVE DENSITY BOTTLES (Pyknometer) With I/C PTFE Stopper

- Supplied with I/C PTFE (Teflon) stopper
- Complies with IS 5717, DIN / ISO 3507
- These bottles are mechanically strong and chemical resistant
- All sizes have a durable matt-finished enamelled area for marking

Product Code	Capacity ml	Capacity Tolerance \pm ml	Max. Body Dia x Height mm	Size of Inter-Changeable Stopper	Quantity Per Case	Price / Piece ₹
1625006	10	1	29 x 48	10 / 15	10	625.00
1625009	25	2	40 x 55	10 / 15	10	690.00
1625012	50	3	50 x 65	10 / 15	5	740.00



1627 - SPECIFIC GRAVITY BOTTLES (PYKNOMETER) With Thermometer And Capillary Side Tube

- Complies with IS 5717, DIN / ISO 3507
- These bottles are mechanically strong and chemical resistant
- All sizes have a durable matt-finished enamelled area for marking
- Supplied with thermometer alongwith certificate for thermometer

Product Code	Capacity ml	Tolerance \pm ml	Max. Body Dia x Height mm	Size of I/C Stopper	Quantity Per Case	Price / Piece ₹
1627006	10	1	29 x 48	10 / 19	5	1775.00
1627009	25	2	40 x 55	10 / 19	5	2080.00
1627012	50	3	50 x 65	10 / 19	5	2255.00

1630 - WEIGHING BOTTLES

With I/C Glass Lid

- Complies with IS 1574
- These bottles are mechanically strong and chemical resistant

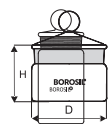

Tall Form



Product Code	Capacity ml	Approx O.D. x Height* mm	Quantity Per Case	Price / Piece ₹
1630005	5	20 x 45	30	330.00
1630007	15	26 x 65	10	350.00
1630008	20**	50 x 35	10	605.00
1630009	25	30 x 65	10	410.00
1630011	40**	60 x 40	10	820.00
1630013	60	40 x 90	5	595.00

*Height indicated is of Bottle only

**Squat Form

1631 - WEIGHING BOTTLES

With I/C Glass Lid, Amber

- Complies with IS 1574
- These bottles are mechanically strong and chemical resistant
- Suitable for light sensitive substance.



Tall Form

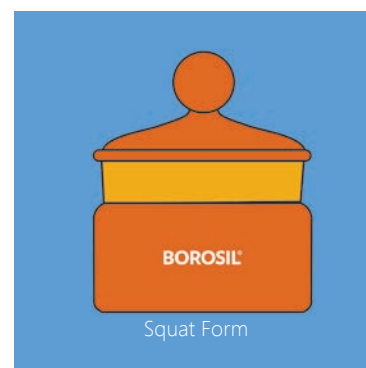

Product Code	Capacity ml	Approx O.D. x Height* mm	Quantity Per Case	Price / Piece ₹
1631005	5	20 x 45	30	425.00
1631007	15	26 x 65	10	445.00
1631008	20**	50 x 35	10	790.00
1631009	25	30 x 65	10	515.00
1631011	40**	60 x 40	10	1025.00
1631013	60	40 x 90	5	775.00

*Height indicated is of Bottle only

**Squat Form

1640 - DROPPING BOTTLES

With Glass Dropper & Rubber Teat

- Supplied with interchangeable ground joint glass dropper and rubber teat
- Highly chemical resistance

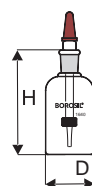

Product Code	Capacity ml	Approx O.D. x Height mm	Socket Size	Quantity Per Case	Price / Piece ₹
1640010	30	34 x 86	14 / 23	10	390.00
1640013	60	42 x 100	14 / 23	10	530.00
1640017	125	55 x 120	19 / 26	10	555.00
1640021	250	65 x 147	19 / 26	10	740.00

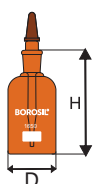

1650 - DROPPING BOTTLES

With Glass Dropper & Rubber Teat, Amber

- Supplied with interchangeable ground joint glass dropper and rubber teat
- Highly chemical resistance
- Suitable for light sensitive substance.

Product Code	Capacity ml	Approx O.D. x Height mm	Socket Size	Quantity Per Case	Price / Piece ₹
1650010	30	35 x 84	14 / 23	10	640.00
1650013	60	42 x 100	14 / 23	10	890.00
1650017	125	55 x 120	19 / 26	10	920.00
1650021	250	65 x 147	19 / 26	10	1205.00

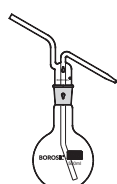

1660 - GLASS WASH BOTTLE

Set With I/C Stopper

- These bottles are mechanically strong and chemical resistant
- All sizes have a durable matt-finished enamelled area for marking

Product Code	Capacity ml	Approx OD mm	Approx Height mm	Size of Inter-changeable Stopper	Quantity Per Case Set	Price / Piece ₹
1660021	250	85	130	24 / 29	5	965.00
1660024	500	105	160	24 / 29	5	1210.00
1660029	1000	131	195	29 / 32	5	1490.00

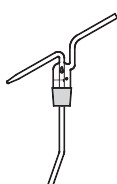

1661 - STOPPER FOR GLASS WASH BOTTLE

Product Code	Capacity ml	Size of Inter-changeable Stopper	Quantity Per Case	Price / Piece ₹
1661021	250	24 / 29	5	635.00
1661024	500	24 / 29	5	680.00
1661029	1000	29 / 32	5	710.00

1662 - FLASK FOR GLASS WASH BOTTLE

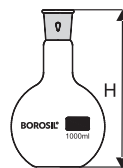

Product Code	Capacity ml	Approx OD mm	Approx Height mm	Size of Inter-changeable Stopper	Quantity Per Case	Price / Piece ₹
1662021	250	85	130	24 / 29	5	580.00
1662024	500	105	160	24 / 29	5	915.00
1662029	1000	131	195	29 / 32	5	1225.00



166P - LDPE PLASTIC WASH BOTTLES

Squeeze Type

- Fitted with delivery tubes
- Bottles and delivery tube made of chemically resistant, low density polyethylene
- Flexible, tough, light weight, and practically unbreakable in use
- Squeezing the bottle produces a steady controllable stream or a few drops.
- Delivery tubes are mounted in polypropylene screw caps
- Tips on delivery tubes are removable



Product Code	Capacity ml	Approx Diameter mm	Bottle Height mm	Quantity Per Case	Price / Piece ₹
166024	500	75	167	36	150.00



1665 - PLASTIC CLAMPS FOR JOINT FITTINGS

- Made of polypropylene for joint fittings

Product Code	Joint mm	Quantity Per Case	Price / Piece ₹
1665B14	B 14	10	75.00
1665B19	B 19	10	75.00
1665B24	B 24	10	80.00
1665B29	B 29	10	80.00



HSN Code: 39235010



1760 - GAS WASHING (DRESCHEL) BOTTLES Set With I/C Stopper

- Complies with IS 11990
- These bottles are mechanically strong and chemical resistant
- All sizes have a durable matt-finished enamelled area for marking

Product Code	Capacity ml	Approx O.D x Height (bottle) mm	Size of Inter-changeable Stopper	Quantity Per Case Set	Price / Piece ₹
1760017	125	50 x 165	29 / 32	5	1525.00
1760021	250	60 x 190	29 / 32	5	1640.00
1760024	500	70 x 245	29 / 32	5	1875.00

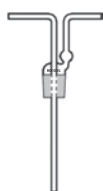

1761 - STOPPER FOR GAS WASHING (DRESCHEL) BOTTLES

Product Code	Capacity ml	Quantity Per Case	Price / Piece ₹
1761017	125	5	825.00
1761021	250	5	860.00
1761024	500	5	985.00

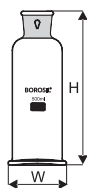

1762 - BOTTLES FOR GAS WASHING (DRESCHEL) BOTTLES

Product Code	Capacity ml	Approx O.D x Height mm	Quantity Per Case	Price / Piece ₹
1762017	125	50 x 165	5	1320.00
1762021	250	60 x 190	5	1450.00
1762024	500	70 x 245	5	1775.00

1764 - GAS SAMPLING TUBES

With Glass Stopcocks

- Complies with DIN 12473



Product Code	Capacity ml	Quantity Per Case	Price / Piece ₹
1764017	125*	10	815.00
1764021	250*	10	955.00
1764024	500	10	1415.00
1764029	1000	10	2320.00

* Not covered in standards



1765 - IMPINGER

- Complies with IS 5182 (Part-VI)
- These bottles are mechanically strong and chemical resistant

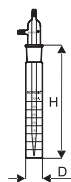

Product Code	Capacity ml	Approx O. D. x Height mm	Quantity Per Case Set	Price / Piece ₹
1765058	35	26 x 220	10	620.00



Burettes



Accuracy, reliability and durability are the three essentials of burettes offered by **BOROSIL Scientific**

Burettes are made from heavy walled, machine drawn borosilicate glass tubing, of precise bore sizes, to provide highest level of accuracy even after repeated usage.

- Complies with highest quality standards according to IS 1997 and ISO 385
- Individually calibrated on automatic calibration machines
- Available in both Class A and Class B tolerances
- Individual calibration certificate provided for Class A Burettes
- Graduation markings made using finest quality white enamel or amber ink to ensure maximum durability
- Stringent control throughout the process of manufacturing and quality checks minimizes the possibility of deviations

Made from 3.3 Low Expansion Borosilicate Glass

USP
TYPE I

TYPE I
ASTM
E438
CLASS A

ISO
3585

BOROSIL Scientific Burettes are fitted with Boroflo GP (General Purpose) stopcocks with PTFE keys that offers the following operational advantages :

- No lubrication required as PTFE key is used, hence no chances of contamination with grease
- Excellent flow control
- All glass/PTFE pathway which is highly resistant to chemical attack
- The unique Fluon/glass seal ensures no leakage
- No springs or retaining devices required
- Easy to dismantle and clean
- Absence of ground surfaces resulting in low absorption of radioactivity
- Consistent performance between 0°C to 50°C

In addition to Boroflo GP stopcock, **BOROSIL** also offers burettes with straight bore glass stopcocks and straight bore PTFE stopcocks



Burette with Boroflo GP stopcock



Burette with PTFE stopcock



Burette with Glass stopcock

- Boroflo stopcocks have PTFE keys which do not require greasing
- The PTFE keys provide best drop control during titration process
- Due to identical shape of PTFE key the Burette valve can be closed with gentle turn.
- PTFE stopcocks have identical keys, hence there is no need to match pairs after cleaning
- PTFE is self lubricating hence the keys do not require greasing
- Specially designed solid glass stopcocks are manufactured from 3.3 Low expansion borosilicate glass
- Glass stopcocks are perfectly ground, for leak free operations



2121 - BURETTES

With Boroflo stopcock, Class A, with Individual Calibration Certificate

- Complies with IS 1997 / ISO 385, Accuracy as per class A
- Supplied with Boroflo stopcock
- No lubrication required
- Calibrated & certified at 27°C and supplied with certificate of calibration traceable to National standards
- Generally used in titration process

Product Code	Capacity ml	Graduation Interval ml	Tolerance \pm ml	Quantity Per Case	Price / Piece ₹
2121006	10	0.05	0.03	5	2340.00
2121U06*	10	0.05	0.02	5	2365.00
2121009	25	0.10	0.05	5	2415.00
2121U09*	25	0.10	0.03	5	2515.00
2121012	50	0.10	0.05	5	2745.00
2121016	100	0.20	0.10	5	3855.00

* Accuracy as per ASTM E287-2 and calibrated at 20°C
50 ml and 100 ml capacities complies both standards - ISO and ASTM for accuracy

2122 - BURETTES

With Boroflo stopcock, Class B

- Complies with IS 1997 / ISO 385, Accuracy as per class B
- Supplied with Boroflo stopcock
- No lubrication required
- Calibrated at 27°C
- Generally used in titration process

Product Code	Capacity ml	Graduation Interval ml	Tolerance \pm ml	Quantity Per Case	Price / Piece ₹
2122006	10	0.05	0.05	10	760.00
2122009	25	0.10	0.10	10	720.00
2122012	50	0.10	0.10	5	800.00
2122016	100	0.20	0.20	5	1205.00

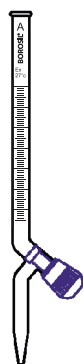

2123 - BURETTES

With Glass stopcock, Class A, with Individual Calibration Certificate

- Complies with IS 1997 / ISO 385, Accuracy as per class A
- Designed with straight bore stopcock that increases the life, compared to Boroflo stopcocks
- The glass stopcock enhances control and enables smoother action
- Calibrated & certified at 27°C and supplied with certificate of calibration traceable to National standards
- Generally used in Titration process

Product Code	Capacity ml	Graduation Interval ml	Tolerance \pm ml	Quantity Per Case	Price / Piece ₹
2123005	5	0.02	0.01	5	2510.00
2123006	10	0.05	0.03	5	2645.00
2123009	25	0.10	0.05	5	2600.00
2123012	50	0.10	0.05	5	2955.00
2123016	100	0.20	0.10	5	4260.00

2124 - BURETTES

With Glass stopcock, Class B

- Complies with IS 1997 / ISO 385, Accuracy as per class B
- Designed with straight bore stopcock that increases the life, compared to Boroflo stopcocks
- The glass stopcock enhances control and enables smoother action
- Calibrated at 27°C
- Generally used in Titration process

Product Code	Capacity ml	Graduation Interval ml	Tolerance \pm ml	Quantity Per Case	Price / Piece ₹
2124005	5	0.02	0.02	5	1015.00
2124006	10	0.05	0.05	10	865.00
2124009	25	0.10	0.10	10	840.00
2124012	50	0.10	0.10	5	915.00
2124016	100	0.20	0.20	5	1280.00

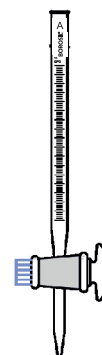



2129 - BURETTES

With PTFE stopcock, Class A, with Individual Calibration Certificate

- Complies with IS 1997 / ISO 385, Accuracy as per class A
- Supplied with PTFE stopcock that is highly resistant to chemical attack
- No lubrication required
- Calibrated & certified at 27°C and supplied with certificate of calibration traceable to National standards
- Generally used in Titration process

Product Code	Capacity ml	Graduation Interval ml	Tolerance \pm ml	Quantity Per Case	Price / Piece ₹
2129012	50	0.1	0.05	5	2955.00

Burettes of other capacities are on request

2130 - BURETTES

With PTFE stopcock, Class B

- Complies with IS 1997 / ISO 385, Accuracy as per class B
- Supplied with PTFE stopcock that is highly resistant to chemical attack
- No lubrication required
- Calibrated at 27°C
- Generally used in Titration process

Product Code	Capacity ml	Graduation Interval ml	Tolerance \pm ml	Quantity Per Case	Price / Piece ₹
2130012	50	0.1	0.1	5	1095.00



2131 - BURETTES

With Boroflo stopcock, Class A, Amber, with Individual Calibration Certificate

- Complies with IS 1997 / ISO 385, Accuracy as per class A
- Supplied with Boroflo stopcock
- No lubrication required
- Calibrated & certified at 27°C and supplied with certificate of calibration traceable to National standards
- Amber coating on exterior surfaces to facilitate use with light sensitive solutions
- Generally used in titration process

Product Code	Capacity ml	Graduation Interval ml	Tolerance \pm ml	Quantity Per Case	Price / Piece ₹
2131009	25	0.10	0.05	5	3980.00
2131012	50	0.10	0.05	5	4410.00

2132 - BURETTES

With Boroflo stopcock, Class B, Amber

- Complies with IS 1997 / ISO 385, Accuracy as per class B
- Supplied with Boroflo stopcock
- No lubrication required
- Calibrated at 27°C
- Amber coating on exterior surfaces to facilitate use with light sensitive solutions
- Generally used in titration process

Product Code	Capacity ml	Graduation Interval ml	Tolerance \pm ml	Quantity Per Case	Price / Piece ₹
2132009	25	0.10	0.10	10	1160.00
2132012	50	0.10	0.10	5	1275.00



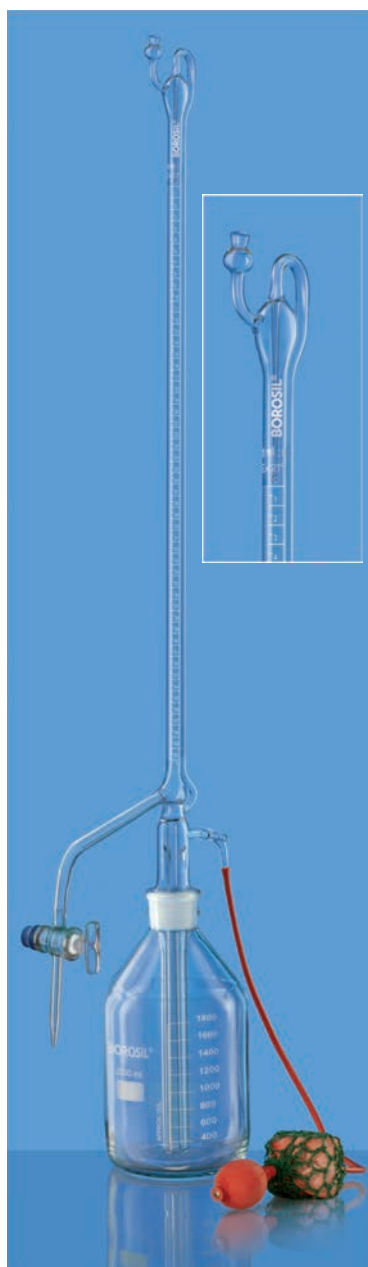

2149 - AUTOBURETTES

With Glass stopcock, Class A, with Individual Calibration Certificate

- Complies with IS 1997 / ISO 385, Accuracy as per class A
- Supplied with Reservoir and Rubber Bellow
- With automatic zero facility
- Calibrated & certified at 27°C and supplied with certificate of calibration traceable to National standards
- Generally used in Titration process

Product Code	Capacity ml	Graduation Interval ml	Tolerance \pm ml	Quantity Per Case	Price / Piece ₹
2149006	10	0.05	0.03	1	10010.00
2149009	25	0.10	0.05	1	9690.00
2149012	50	0.10	0.05	1	10835.00
2149016	100	0.20	0.10	1	12335.00

Reservoir Capacity : 500 ml for 10 ml size and 2000 ml for 25, 50 and 100 ml sizes.

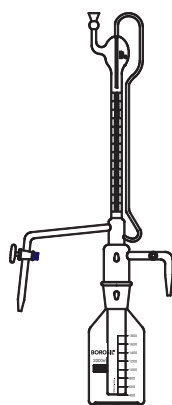

2150 - AUTOBURETTES

With Glass stopcock, Class B

- Complies with IS 1997 / ISO 385, Accuracy as per class B
- Supplied with Reservoir and Rubber Bellow
- With automatic zero facility
- Calibrated at 27°C
- Generally used in Titration process

Product Code	Capacity ml	Graduation Interval ml	Tolerance \pm ml	Quantity Per Case	Price / Piece ₹
2150006	10	0.05	0.05	1	6570.00
2150009	25	0.10	0.10	1	6460.00
2150012	50	0.10	0.10	1	7000.00
2150016	100	0.20	0.20	1	7975.00

Reservoir Capacity : 500 ml for 10 ml size and 2000 ml for 25, 50 and 100 ml sizes.

2149A - AUTOBURETTES

With Glass stopcock, Class A, Amber, with Individual Calibration Certificate

- Complies with IS 1997 / ISO 385, Accuracy as per class A
- Supplied with Reservoir and Rubber Bellow
- With automatic zero facility
- Calibrated & certified at 27°C and supplied with certificate of calibration traceable to National standards
- Amber coating on exterior surfaces to facilitate use with light sensitive solutions
- Generally used in Titration process

Product Code	Capacity ml	Graduation Interval ml	Tolerance \pm ml	Quantity Per Case	Price / Piece ₹
2149A06	10	0.05	0.03	1	20585.00
2149A09	25	0.10	0.05	1	21825.00
2149A12	50	0.10	0.05	1	24015.00
2149A16	100	0.20	0.10	1	24810.00

Reservoir Capacity : 500 ml for 10 ml size and 2000 ml for 25, 50 and 100 ml sizes.

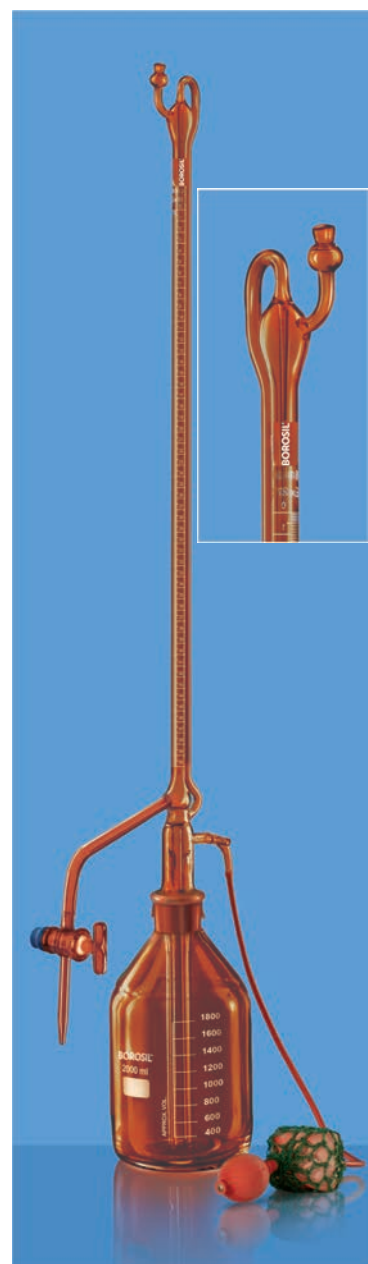
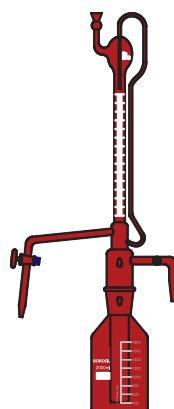

2150A - AUTOBURETTES

With Glass stopcock, Class B, Amber

- Complies with IS 1997 / ISO 385, Accuracy as per class B
- Supplied with Reservoir and Rubber Bellow
- With automatic zero facility
- Calibrated at 27°C
- Amber coating on exterior surfaces to facilitate use with light sensitive solutions
- Generally used in Titration process

Product Code	Capacity ml	Graduation Interval ml	Tolerance \pm ml	Quantity Per Case	Price / Piece ₹
2150A06	10	0.05	0.05	1	14355.00
2150A09	25	0.10	0.10	1	14565.00
2150A12	50	0.10	0.10	1	14860.00
2150A16	100	0.20	0.20	1	15585.00

Reservoir Capacity : 500 ml for 10 ml size and 2000 ml for 25, 50 and 100 ml sizes.



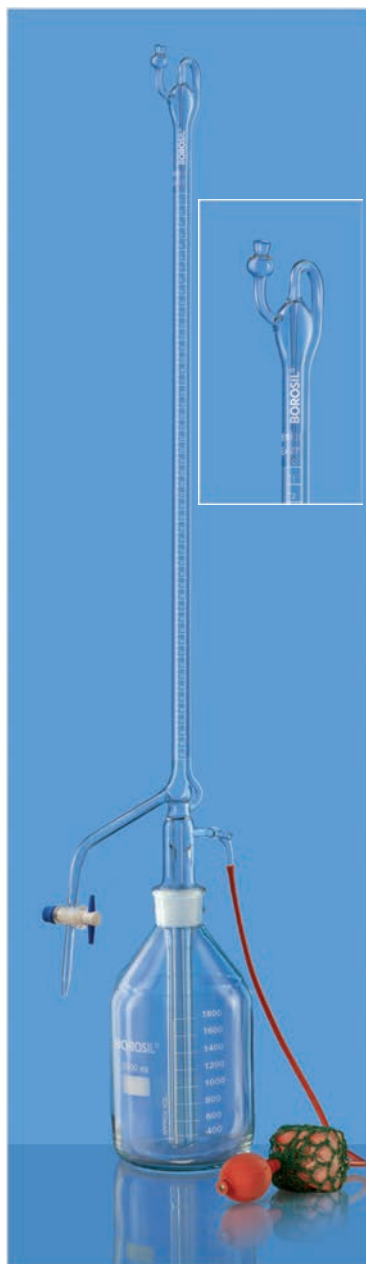

2153 - AUTOBURETTES

With PTFE Stopcock, Class A, with Individual Calibration Certificate

- Complies with IS 1997 / ISO 385, Accuracy as per class A
- Supplied with PTFE stopcock that is highly resistant to chemical attack
- Supplied with Reservoir and Rubber Bellow
- With automatic zero facility
- Calibrated & certified at 27°C and supplied with certificate of calibration traceable to National standards
- Generally used in titration process

Product Code	Capacity ml	Graduation Interval ml	Tolerance \pm ml	Quantity Per Case	Price / Piece ₹
2153006	10	0.05	0.03	1	10560.00
2153009	25	0.10	0.05	1	10320.00
2153012	50	0.10	0.05	1	11445.00
2153016	100	0.20	0.10	1	13085.00

Reservoir Capacity : 500 ml for 10 ml size and 2000 ml for 25, 50 and 100 ml sizes.

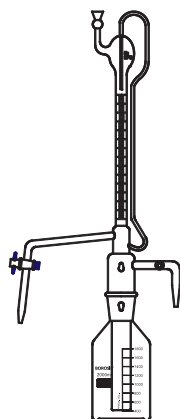

2154 - AUTOBURETTES

With PTFE stopcock, Class B

- Complies with IS 1997 / ISO 385, Accuracy as per class B
- Supplied with PTFE stopcock that is highly resistant to chemical attack
- Supplied with Reservoir and Rubber Bellow
- With automatic zero facility
- Calibrated at 27°C
- Generally used in titration process

Product Code	Capacity ml	Graduation Interval ml	Tolerance \pm ml	Quantity Per Case	Price / Piece ₹
2154006	10	0.05	0.05	1	6930.00
2154009	25	0.10	0.10	1	6785.00
2154012	50	0.10	0.10	1	7370.00
2154016	100	0.20	0.20	1	8365.00

Reservoir Capacity : 500 ml for 10 ml size and 2000 ml for 25, 50 and 100 ml sizes.

2153A - AUTOBURETTES

With PTFE stopcock, Class A, Amber, with Individual Calibration Certificate

- Complies with IS 1997 / ISO 385, Accuracy as per class A
- Supplied with PTFE stopcock that is highly resistant to chemical attack
- Supplied with Reservoir and Rubber Bellow
- With automatic zero facility
- Calibrated & certified at 27°C and supplied with certificate of calibration traceable to National standards
- Amber coating on exterior surfaces to facilitate use with light sensitive solutions
- Generally used in titration process

Product Code	Capacity ml	Graduation Interval ml	Tolerance \pm ml	Quantity Per Case	Price / Piece ₹
2153A06	10	0.05	0.03	1	21350.00
2153A09	25	0.10	0.05	1	22790.00
2153A12	50	0.10	0.05	1	24955.00
2153A16	100	0.20	0.10	1	26115.00

Reservoir Capacity : 500 ml for 10 ml size and 2000 ml for 25, 50 and 100 ml sizes.

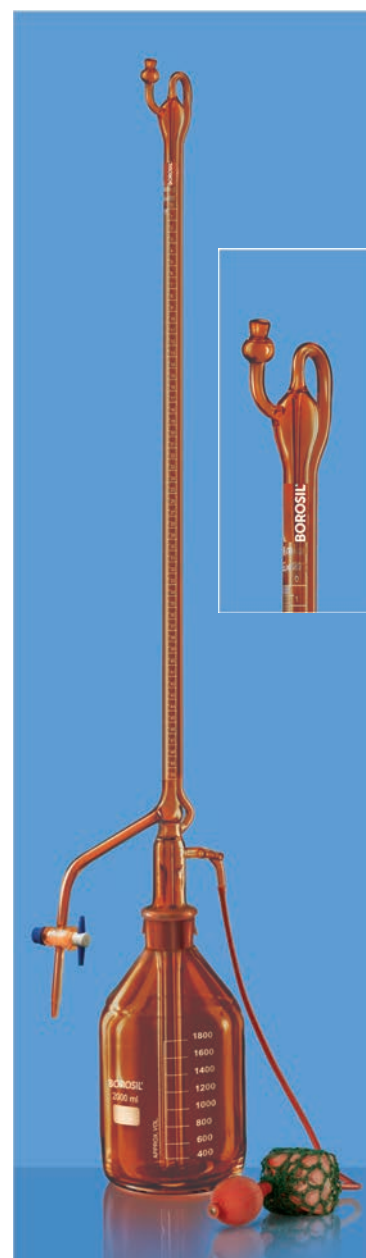
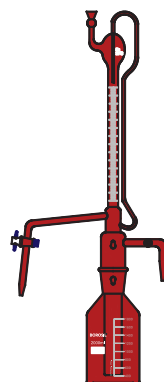

2154A - AUTOBURETTES

With PTFE stopcock, Class B, Amber

- Complies with IS 1997 / ISO 385, Accuracy as per class B
- Supplied with PTFE stopcock that is highly resistant to chemical attack
- Supplied with Reservoir and Rubber Bellow
- With automatic zero facility
- Calibrated at 27°C
- Amber coating on exterior surfaces to facilitate use with light sensitive solutions
- Generally used in titration process

Product Code	Capacity ml	Graduation Interval ml	Tolerance \pm ml	Quantity Per Case	Price / Piece ₹
2154A06	10	0.05	0.05	1	14565.00
2154A09	25	0.10	0.10	1	13700.00
2154A12	50	0.10	0.10	1	14065.00
2154A16	100	0.20	0.20	1	14710.00

Reservoir Capacity : 500 ml for 10 ml size and 2000 ml for 25, 50 and 100 ml sizes.





2155 - AUTOBURETTES

With Boroflo stopcock, Class A, with Individual Calibration Certificate

- Complies with IS 1997 / ISO 385, Accuracy as per class A
- Supplied with Boroflo stopcock, Reservoir and Rubber Bellow
- With automatic zero facility
- Calibrated & certified at 27°C and supplied with certificate of calibration traceable to National standards
- Generally used in titration process

Product Code	Capacity ml	Graduation Interval ml	Tolerance \pm ml	Quantity Per Case	Price / Piece ₹
2155006	10	0.05	0.03	1	9670.00
2155009	25	0.10	0.05	1	9420.00
2155012	50	0.10	0.05	1	10460.00
2155016	100	0.20	0.10	1	11890.00

Reservoir Capacity : 500 ml for 10 ml size and 2000 ml for 25, 50 and 100 ml sizes.

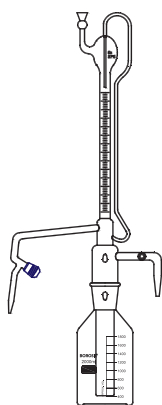

2156 - AUTOBURETTES

With Boroflo stopcock, Class B

- Complies with IS 1997 / ISO 385, Accuracy as per class B
- Supplied with Boroflo stopcock, Reservoir and Rubber Bellow
- With automatic zero facility
- Calibrated at 27°C
- Generally used in titration process

Product Code	Capacity ml	Graduation Interval ml	Tolerance \pm ml	Quantity Per Case	Price / Piece ₹
2156006	10	0.05	0.05	1	6390.00
2156009	25	0.10	0.10	1	6245.00
2156012	50	0.10	0.10	1	6840.00
2156016	100	0.20	0.20	1	7850.00

Reservoir Capacity : 500 ml for 10 ml size and 2000 ml for 25, 50 and 100 ml sizes.

2155A - AUTOBURETTES

With Boroflo stopcock, Class A, Amber, with Individual Calibration Certificate

- Complies with IS 1997 / ISO 385, Accuracy as per class A
- Supplied with Boroflo stopcock, Reservoir and Rubber Bellow
- With automatic zero facility
- Amber coating on exterior surfaces to facilitate use with light sensitive solutions
- Calibrated & certified at 27°C and supplied with certificate of calibration traceable to National standards
- Generally used in titration process

Product Code	Capacity ml	Graduation Interval ml	Tolerance \pm ml	Quantity Per Case	Price / Piece ₹
2155A06	10	0.05	0.03	1	20340.00
2155A09	25	0.10	0.05	1	21490.00
2155A12	50	0.10	0.05	1	23875.00
2155A16	100	0.20	0.10	1	24665.00

Reservoir Capacity : 500 ml for 10 ml size and 2000 ml for 25, 50 and 100 ml sizes.

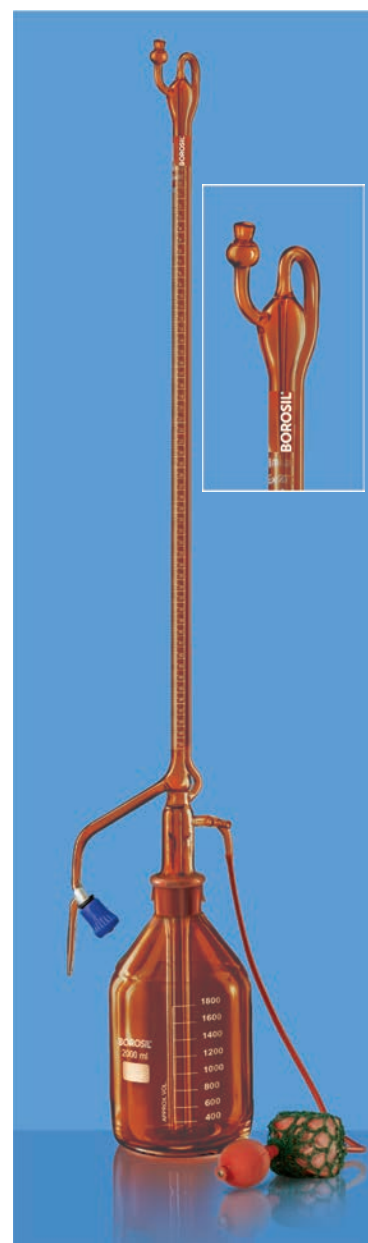
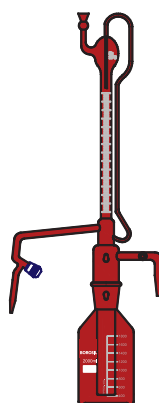

2156A - AUTOBURETTES

With Boroflo stopcock, Class B, Amber

- Complies with IS 1997 / ISO 385, Accuracy as per class B
- Supplied with Boroflo stopcock, Reservoir and Rubber Bellow
- With automatic zero facility
- Calibrated at 27°C
- Amber coating on exterior surfaces to facilitate use with light sensitive solutions
- Generally used in titration process

Product Code	Capacity ml	Graduation Interval ml	Tolerance \pm ml	Quantity Per Case	Price / Piece ₹
2156A06	10	0.05	0.05	1	14210.00
2156A09	25	0.10	0.10	1	14355.00
2156A12	50	0.10	0.10	1	14790.00
2156A16	100	0.20	0.20	1	15360.00

Reservoir Capacity : 500 ml for 10 ml size and 2000 ml for 25, 50 and 100 ml sizes.

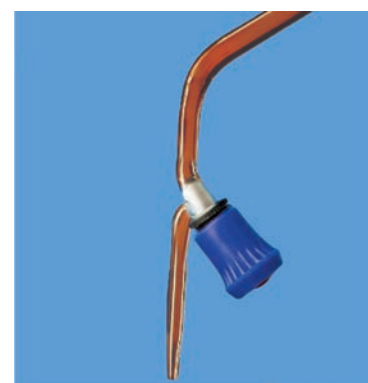

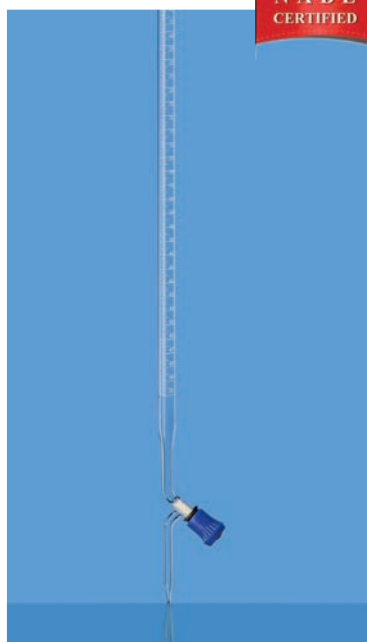

2000 - BURETTES

With Boroflo stopcock, NABL Certified, Class A, with Individual Calibration Certificate

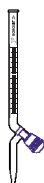

- Complies with IS 1997 / ISO 385, Accuracy as per class A
- Supplied with Boroflo stopcock
- No lubrication required
- Calibrated & certified at 27°C and supplied with NABL certificate of calibration traceable to National standards
- Generally used in titration process

Product Code	Capacity ml	Graduation Interval ml	Tolerance \pm ml	Quantity Per Case	Price / Piece ₹
2000006	10	0.05	0.03	1	4615.00
2000009	25	0.10	0.05	1	4780.00
2000012	50	0.10	0.05	1	5395.00
2000016	100	0.20	0.10	1	7580.00



2001 - BURETTES

With Boroflo stopcock, NABL Certified, Class A, Amber, with Individual Calibration Certificate

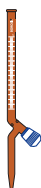

- Complies with IS 1997 / ISO 385, Accuracy as per class A
- Supplied with Boroflo stopcock
- No lubrication required
- Calibrated & certified at 27°C and supplied with NABL certificate of calibration traceable to National standards
- Amber coating on exterior surfaces to facilitate use with light sensitive solutions
- Generally used in titration process

Product Code	Capacity ml	Graduation Interval ml	Tolerance \pm ml	Quantity Per Case	Price / Piece ₹
2001009	25	0.1	0.05	1	7315.00
2001012	50	0.1	0.05	1	8295.00



2002 - BURETTES

With Glass stopcock, NABL Certified, Class A, with Individual Calibration Certificate



- Complies with IS 1997 / ISO 385, Accuracy as per class A
- Designed with straight bore stopcock that increases the life, compared to PTFE key stopcocks
- The glass stopcock enhances control and enables smoother action
- Calibrated & certified at 27°C and supplied with NABL certificate of calibration traceable to National standards
- Generally used in titration process

Product Code	Capacity ml	Graduation Interval ml	Tolerance \pm ml	Quantity Per Case	Price / Piece ₹
2002006	10	0.05	0.03	1	4750.00
2002009	25	0.10	0.05	1	4920.00
2002012	50	0.10	0.05	1	5620.00
2002016	100	0.20	0.10	1	8000.00

BOROSIL[®]
Scientific

Laboratory Accessories

For safer experiments



For more details please refer page no. 218-225

Cones

Cones are used to determine small amounts of suspended matter in sewage by the Imhoff Sedimentation Method.

Made from 3.3 Low Expansion Borosilicate Glass



2160 - IMHOFF CONE

Sharp Tip

- Complies with IS 7232
- Graduated from 0 to 1 ml in 0.1 ml divisions
- Graduated from 1 to 10 ml in 0.5 ml divisions
- 10 to 40 ml in 1 ml divisions also marked at 1000 ml
- Facilitates the determination of the amount of sediment in sewage or industrial waste

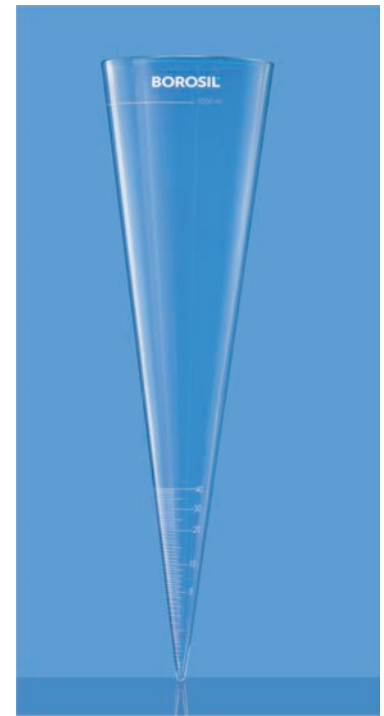
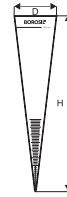

Product Code	Approx Total Height mm	Approx Top Diameter mm	Quantity Per Case	Price / Piece ₹
2160094	454	110	1	6790.00

2180 - IMHOFF CONE

Blunt Tip

- Complies with IS 7232
- The blunt tip increases its ruggedness and cleaning ease
- Ideal for use with heavy sediments where the ability to read small volumes is unimportant
- Facilitates the determination of the amount of sediment in sewage or industrial waste



Product Code	Approx Total Height mm	Approx Top Diameter mm	Quantity Per Case	Price / Piece ₹
2180093	439	110	1	6930.00

Condensers

A Condenser is designed to facilitate the cooling of hot vapours and liquids. It is structured in the form of a large glass tube, containing a smaller glass tube running through its entire length. Hot fluids pass through this small inner tube.

Typically, the outer glass tube has two hose connections to aid the passing of a coolant (usually tap water or chilled water/anti-freeze mixture). The coolant is introduced through the lower fitting, while the higher fitting serves as the exit point. Entering the coolant at the cooler point is a critical aspect as it helps maintain a smooth and correctly directed thermal gradient. This in turn, maximises efficiency and minimises the risk of thermal shock to adjacent glassware. Multiple Condensers may be connected in a series. Usually, a high flow rate is not essential for maintaining a cooling surface.

Special care should be taken while choosing Condensers keeping in mind their distillation rates, reflux rates and temperature gradients.

Borosil offers you the choice of a wide range of Condensers.

**Made from 3.3 Low Expansion
Borosilicate Glass**

USP
TYPE I

TYPE I
ASTM
E438
CLASS A

ISO
3585



2340 - LIEBIG CONDENSER

With Sealed Inner Tube

- Complies with IS 6052
- The light wall of the inner tube facilitates efficient heat transfer
- Low cooling capacity
- Used for distillate separation

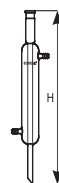

Product Code	Approx Jacket Length mm	Approx Overall Height mm	Ground Joint	Quantity Per Case	Price / Piece ₹
2340087	200	350	19 / 15	5	700.00
2340090	300	450	19 / 15	5	595.00
2340092	400	550	19 / 15	5	620.00
2340095	500	650	19 / 15	5	755.00



2400 - LIEBIG CONDENSER

With Drip Tip

- Complies with IS 6052
- With interchangeable inner and outer joints
- The light wall of the inner tube facilitates efficient heat transfer
- Low cooling capacity
- Used for distillate separation



Product Code	Approx Jacket Length mm	Approx Overall Height mm	Ground Joint		Quantity Per Case	Price / Piece ₹
			Socket	Cone		
2400087	200	350	19 / 26	19 / 26	5	700.00
2400A87	200	350	24 / 29	24 / 29	5	700.00
2400090	300	450	24 / 29	24 / 29	5	770.00
2400A90	300	450	19 / 26	19 / 26	5	770.00
2400092	400	550	24 / 29	24 / 29	5	895.00
2400A92	400	550	19 / 26	19 / 26	5	895.00

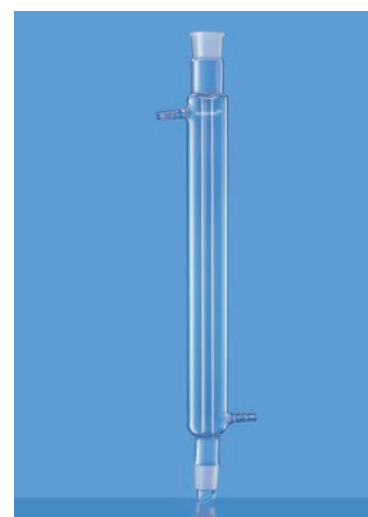

2480 - ALLIHN CONDENSER

With Drip Tip

- Complies with IS 6052
- With Interchangeable Inner and Outer Joint
- Greater surface area than the Liebig Condenser owing to a series of bulbs, resulting in higher cooling capacity
- Ideal for laboratory scale refluxing

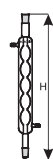

Product Code	Approx Jacket Length mm	Approx Overall Height mm	Ground Joint		Quantity Per Case	Price / Piece ₹
			Socket	Cone		
2480087	200	350	19 / 26	19 / 26	5	895.00
2480A87	200	350	24 / 29	24 / 29	5	895.00
2480090	300	450	24 / 29	24 / 29	5	940.00
2480A90	300	450	19 / 26	19 / 26	5	940.00
2480092	400	550	24 / 29	24 / 29	5	1090.00
2480A92	400	550	29 / 32	29 / 32	5	1090.00
2480096	600	750	29 / 32	29 / 32	5	1475.00
2480A96	600	750	24 / 29	24 / 29	5	1475.00



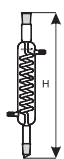

2560 - GRAHAM COILED CONDENSER With Drip Tip

- Complies with IS 6052
- With Interchangeable Inner and Outer Joint
- The coiled condensation tubes result in greater surface area for cooling
- Designed with top standard taper outer and lower inner drip tip joint

Product Code	Approx Jacket Length mm	Approx Overall Height mm	Ground Joint		Quantity Per Case	Price / Piece ₹
			Socket	Cone		
2560090	300	450	24 / 29	24 / 29	5	1075.00
2560A90	300	450	19 / 26	19 / 26	5	1075.00
2560092	400	550	24 / 29	24 / 29	5	1105.00
2560A92	400	550	29 / 32	29 / 32	5	1105.00
2560095	500	650	24 / 29	24 / 29	5	1390.00
2560A95	500	650	29 / 32	29 / 32	5	1390.00

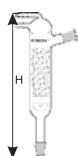

2640 - FRIEDRICH CONDENSER With Drip Tip

- Complies with IS 6052
- With Interchangeable Inner and Outer Joint
- Specially designed inner spiral tubes ensure along vapour path
- Offer better heat transfer and anti-flooding capabilities

Product Code	Approx Jacket Length mm	Ground Joint		Quantity Per Case	Price / Piece ₹
		Socket	Cone		
2640097	350	24 / 29	24 / 29	5	4315.00

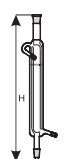
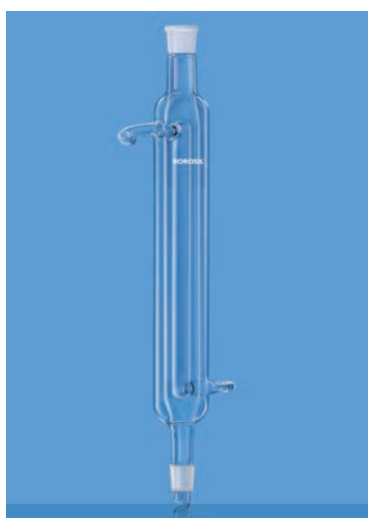

2641 - DOUBLE SURFACE CONDENSER

- Complies with IS 6052

Product Code	Approx Jacket Length mm	Approx Overall Height mm	Ground Joint	Quantity Per Case	Price / Piece ₹
2641087	200	345	19 / 26	5	2745.00
2641187	200	360	24 / 29	5	2925.00
2641090	300	454	19 / 26	5	3615.00
2641190	300	450	24 / 29	5	3955.00

The above condensers are widely used in research labs. A double-surface condenser has a water jacket both on the outside and through the centre of the condensing tube. It is needed where the condensed liquid is very volatile. Hence for distilling ethers, alcohols, esters, aromatics, petroleum products and essential oils these condensers are widely used.

Temperature controlled Heating Mantles

Temperature Controlled Heating Mantles are indispensable tools in the laboratory. The equipment precisely fits the boiling and distillation flask, round bottom flasks, or relevant reaction vessels, providing consistent and controllable heating of organic liquids required for the boiling, evaporation, distillation, or extraction process. With their advanced temperature control capabilities, Heating Mantles ensure optimal conditions for various scientific procedures, enhancing efficiency and accuracy in experimentation.

The Integrated PID control for better temperature accuracy & Integrated retort rod holder for space saving apparatus assembly.

- It also Includes PT 100 external temperature probe with auto detection on plug in and is able to monitor reaction times exclusively.
- Automatic spill detection and safety shutdown, protective fuse.
- Built in temperature calibration and, safe temperature setting

Call or Write to us

Email id: lab.support@borosil.com
Toll Free Number: 1800 224 551



Cylinders

Measuring cylinders are the most common and essential measuring devices used in any laboratory. **BOROSIL Scientific** Cylinders are made from heavy walled, machine drawn borosilicate glass tubing which makes them sturdy for daily laboratory use.

BOROSIL Scientific offers cylinders from capacities 5ml to 2000ml, with penny head stoppers.

Made from 3.3 Low Expansion
Borosilicate Glass



- Complies with highest quality standards according to IS 878, ASTM E1272 and ISO 4788
- All measuring cylinders are calibrated to contain (TC, In) and all tolerances are according to IS/ISO/DIN/ASTM class "A" Standards
- Individually calibrated on automatic calibration machine
- Available in both Class A and Class B tolerances
- Individual calibration certificate provided for Class A pipettes
- Graduation markings made using finest quality white enamel or amber ink to ensure maximum durability
- Stringent control throughout the process of manufacturing and quality checks minimizes the possibility of deviations
- Specially designed with hexagonal base for enhance stability
- Spout allows drip free pouring

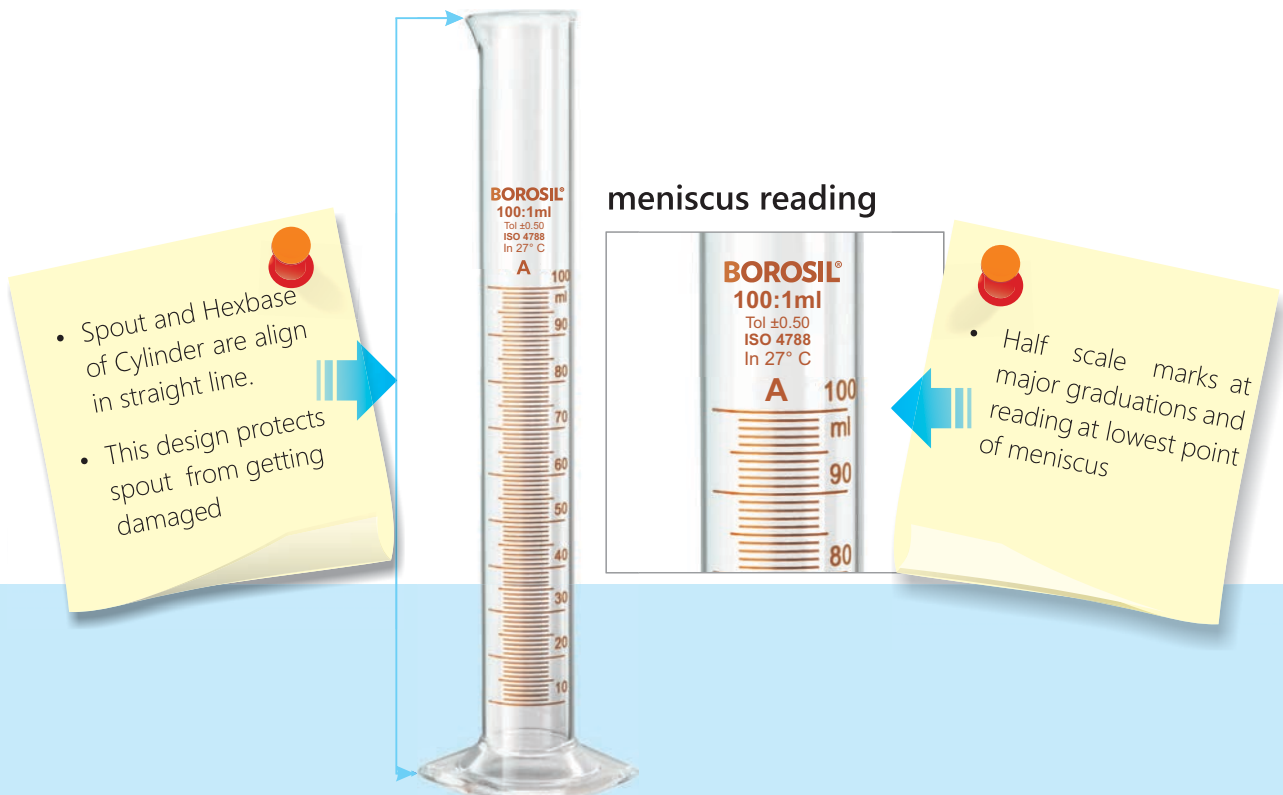

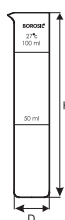

2975 - NESSLER CYLINDERS

- Complies with IS 4161
- Facilitates colour comparison of water samples, freedom from colour or visible defects
- White enamel inscriptions
- Calibrated at 27°C

Product Code	Capacity ml	Approx O.D. x Height	Tolerance \pm ml	Quantity Per Case	Price / Piece ₹
2975009	25	19 x 165	0.20	10	215.00
2975012	50	25 x 150	0.40	20	230.00
2975016	100	34 x 180	0.80	30	335.00



2981 - CYLINDERS

Class A, Hexagonal Base, with I/C Stopper, with Individual Calibration Certificate

- Complies with IS 878, ISO 4788
- Supplied with Interchangeable Penny head Stopper
- Graduated, Single Metric Scale
- Each cylinder is engraved with a unique serial number, and comes with a Certificate of Calibration traceable to national standards
- Graduations in amber enamel
- Sturdy hexagonal base prevents roll-over and ensures greater stability
- Calibrated and certified at 27°C

Product Code	Capacity ml	Graduation Interval ml	Tolerance \pm ml	Stopper Size	Quantity Per Case	Price / Piece ₹
2981005	5	0.1	0.05	10 / 19	5	955.00
2981006	10	0.2	0.10	10 / 19	5	1055.00
2981009	25	0.5	0.25	14 / 23	10	1210.00
2981012	50	1	0.50	14 / 23	10	1375.00
2981016	100	1	0.50	19 / 26	10	1605.00
2981021	250	2	1	24 / 29	5	2520.00
2981024	500	5	2.5	24 / 29	5	3240.00
2981029	1000	10	5	34 / 35	4	3960.00
2981030	2000	20	10	34 / 35	4	6300.00

2982 - CYLINDERS

Class B, Hexagonal Base, with I/C Stopper

- Complies with IS 878, ISO 4788
- Supplied with Interchangeable Penny head Stopper
- Graduated, Single Metric Scale
- Graduations in amber enamel
- Sturdy hexagonal base prevents roll-over and ensures greater stability
- Calibrated at 27°C



Product Code	Capacity ml	Graduation Interval ml	Tolerance ± ml	Stopper Size	Quantity Per Case	Price / Piece ₹
2982005	5	0.1	0.1	10 / 19	5	510.00
2982006	10	0.2	0.2	10 / 19	5	540.00
2982009	25	0.5	0.5	14 / 23	10	605.00
2982012	50	1	1	14 / 23	10	680.00
2982016	100	1	1	19 / 26	10	835.00
2982021	250	2	2	24 / 29	10	1415.00
2982024	500	5	5	24 / 29	5	1965.00
2982029	1000	10	10	34 / 35	4	2835.00
2982030	2000	20	20	34 / 35	4	4900.00

2983 - CYLINDERS

USP, Class A, Hexagonal Base, with I/C Stopper, with Individual Calibration Certificate

- Tolerance complies with ASTM E 1272 and dimension as per ISO 4788
- Supplied with Interchangeable Penny head Stopper
- Graduated, Single Metric Scale
- Each cylinder is engraved with a unique serial number, and comes with a Certificate of Calibration traceable to national standards
- Graduations in amber enamel
- Sturdy hexagonal base prevents roll-over and ensures greater stability
- Calibrated and certified at 20°C



Product Code	Capacity ml	Graduation Interval ml	Tolerance ± ml	Stopper Size	Quantity Per Case	Price / Piece ₹
2983005	5	0.1	0.05	10 / 19	5	1000.00
2983006	10	0.2	0.10	10 / 19	5	1150.00
2983009	25	0.5	0.17	14 / 23	10	1295.00
2983012	50	1	0.25	14 / 23	10	1545.00
2983016	100	1	0.50	19 / 26	10	1725.00
2983021	250	2	1	24 / 29	5	2775.00
2983024	500	5	2	24 / 29	5	3305.00
2983029	1000	10	3	34 / 35	4	4075.00
2983030	2000	20	6	34 / 35	4	7640.00

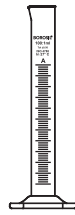

3021 - CYLINDERS

Class A, Hexagonal base, Pour out, with Individual Calibration Certificate

- Complies with IS 878, ISO 4788
- Graduated, Single Metric Scale
- Each cylinder is engraved with a unique serial number, and comes with a Certificate of Calibration traceable to national standards
- Graduations in amber enamel
- Sturdy hexagonal base prevents roll-over and ensures greater stability
- Calibrated and certified at 27°C

Product Code	Capacity ml	Graduation Interval ml	Tolerance \pm ml	Quantity Per Case	Price / Piece ₹
3021005	5	0.1	0.05	5	565.00
3021006	10	0.2	0.1	5	650.00
3021008	20*	0.1	0.25	10	825.00
3021009	25	0.5	0.25	10	745.00
3021012	50	1	0.5	10	905.00
3021016	100	1	0.5	10	1025.00
3021018	150*	2	1	5	1360.00
3021021	250	2	1	10	1510.00
3021024	500	5	2.5	5	2105.00
3021029	1000	10	5	4	2570.00
3021030	2000	20	10	4	5000.00

* As per Borosil Scientific standards.

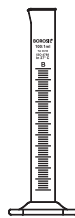
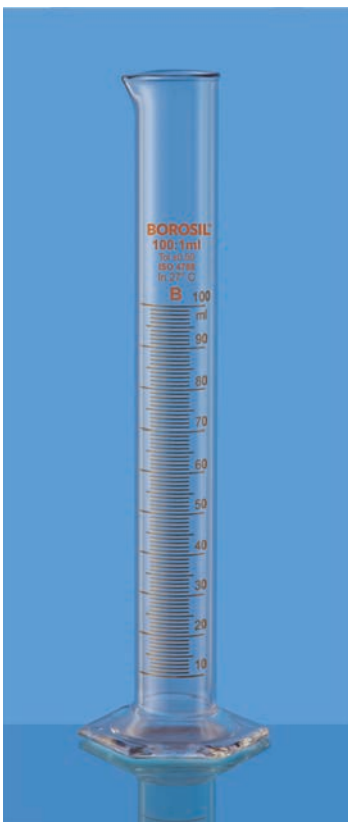

3022 - CYLINDERS

Class B, Hexagonal base, Pour out

- Complies with IS 878, ISO 4788
- Graduated, Single Metric Scale
- Certificate of Calibration traceable to national standards
- Graduations in amber enamel
- Sturdy hexagonal base prevents roll-over and ensures greater stability
- Calibrated at 27°C

Product Code	Capacity ml	Graduation Interval ml	Tolerance \pm ml	Quantity Per Case	Price / Piece ₹
3022005	5	0.1	0.1	5	310.00
3022006	10	0.2	0.2	5	370.00
3022009	25	0.5	0.5	10	430.00
3022012	50	1	1	20	470.00
3022016	100	1	1	20	530.00
3022018	150*	2	2	5	785.00
3022021	250	2	2	10	985.00
3022024	500	5	5	5	1280.00
3022029	1000	10	10	4	1945.00
3022030	2000	20	20	4	3730.00

*150 ml Not covered in any standards.

3026 - CYLINDERS

ASTM, Class A, Hexagonal base, Pour out, with Individual Calibration Certificate

- Complies with ASTM E 1272
- Graduated, Single Metric Scale
- Each cylinder is engraved with a unique serial number, and comes with a Certificate of Calibration traceable to national standards
- Graduations in amber enamel
- Sturdy hexagonal base prevents roll-over and ensures greater stability
- Calibrated and certified at 20°C



Product Code	Capacity ml	Graduation Interval ml	Tolerance ± ml	Quantity Per Case	Price / Piece ₹
3026005	5	0.1	0.05	5	685.00
3026006	10	0.2	0.10	5	790.00
3026009	25	0.5	0.17	5	895.00
3026012	50	1	0.25	5	1065.00
3026016	100	1	0.50	5	1190.00
3026021	250	2	1	5	1730.00
3026024	500	5	2	4	2280.00
3026029	1000	10	3	4	2815.00
3026030	2000	20	6	4	5260.00

3027 - CYLINDERS

ASTM, Class B, Hexagonal base, Pour out

- Complies with ASTM E 1272
- Graduated, Single Metric Scale
- Each cylinder is engraved with a unique serial number, and comes with a Certificate of Calibration traceable to national standards
- Graduations in amber enamel
- Sturdy hexagonal base prevents roll-over and ensures greater stability
- Calibrated at 20°C

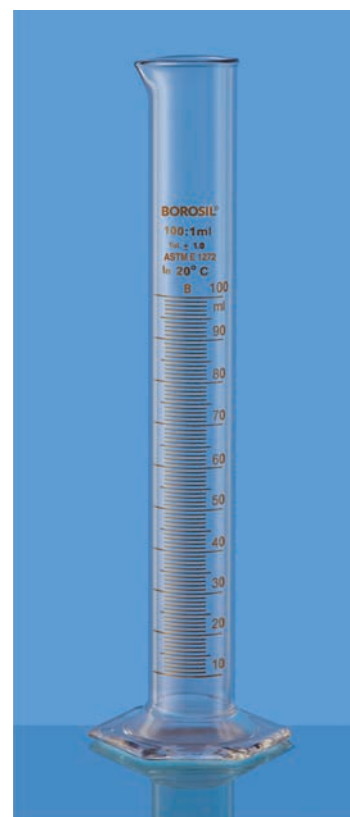

Till stock lasts					
Product Code	Capacity ml	Graduation Interval ml	Tolerance ± ml	Quantity Per Case	Price / Piece ₹
3027005	5	0.1	0.1	5	400.00
3027006	10	0.2	0.2	5	460.00
3027009	25	0.5	0.34	10	540.00
3027012	50	1	0.5	10	605.00
3027016	100	1	1	10	660.00
3027021	250	2	2	10	1155.00
3027024	500	5	4	5	1440.00
3027029	1000	10	6	4	2140.00
3027030	2000	20	12	4	3950.00

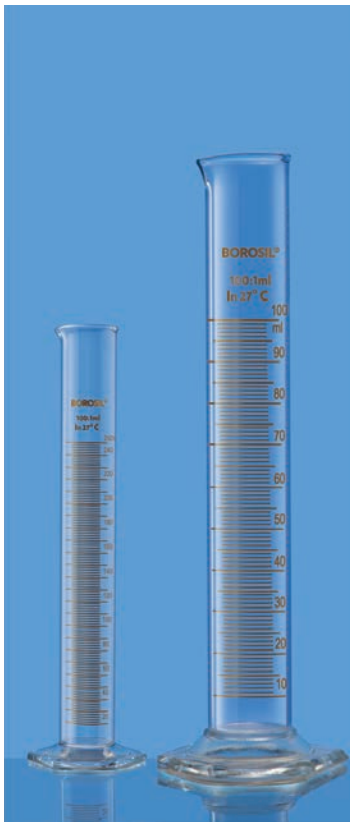

3032 - TAPPED DENSITY CYLINDER

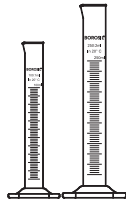

- As Per USP, Ch. 616
- Supplied as a set of two cylinders
- Used in tapped density apparatus to measure bulk density of powders
- Graduation in amber enamel
- Sturdy hexagonal base prevents roll-over and ensures greater stability
- Calibrated at 20°C

Product Code	Capacity ml	Quantity Per Case Set	Price / Set ₹
3032041	100 & 250	1 Each	3215.00

3033 - TAPPED DENSITY CYLINDER



- As Per USP, Ch. 616

Product Code	Capacity ml	Quantity Per Case Set	Price / Piece ₹
3033016	100	2	1675.00

3034 - TAPPED DENSITY CYLINDER



- As Per USP, Ch. 616

Product Code	Capacity ml	Quantity Per Case Set	Price / Piece ₹
3034021	250	2	1930.00

3070 - RAIN MEASURE CYLINDERS

Round base



- Complies with IS 4849
- Graduated, Single metric scale
- Graduation in white enamel
- The cylinders are graduated to indicate rainfall in mm when used with appropriate rain collector
- Calibrated at 27°C

Product Code	Size mm	Used For Collector Area cm ²	Graduation Interval mm	Tolerance ± ml	Quantity Per Case	Price / Piece ₹
3070096	20	200	0.2	0.05	5	1445.00
3070098	20	100	0.2	0.10	10	1690.00

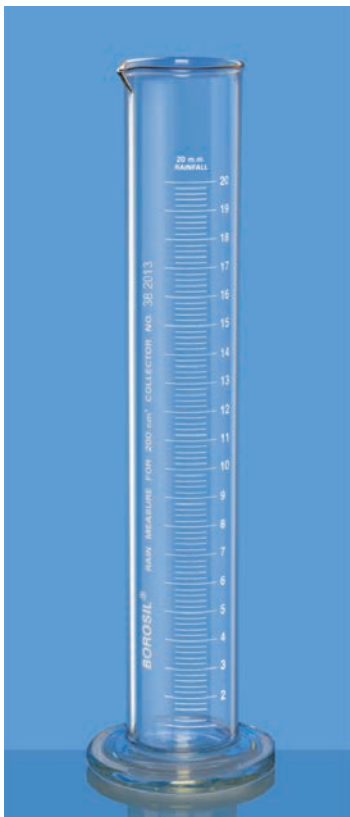

3041 - CROW CYLINDER

Class A, with Individual Calibration Certificate

- Complies with BS 658 standard
- Graduated Single metric scale
- Each cylinder is engraved with a unique serial number and is provided with a calibration certificate traceable to national standards
- Graduations in amber enamel
- Calibrated and certified at 20°C
- Ideal for the collection and measurement of distillate in oil and jar tests

Product Code	Capacity ml	Tolerance ± ml	Quantity Per Case	Price / Piece ₹
3041016	100	0.4	5	1715.00

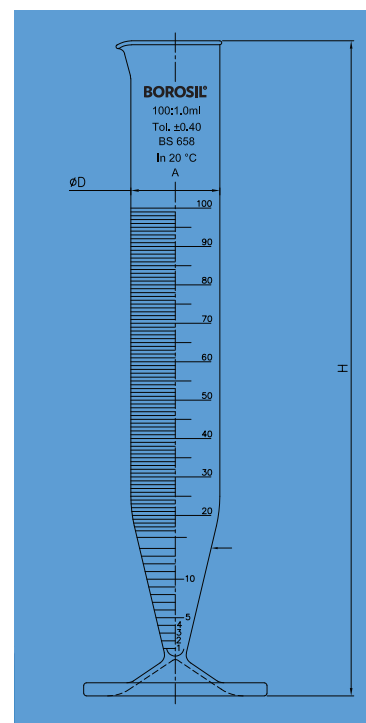

2010 - CYLINDERS

NABL Certified, Class A, Hexagonal base, Pour out, with Individual Calibration Certificate

- Complies with IS 1997, ISO 4788
- Graduated, Single Metric Scale
- Calibrated & certified at 27°C and supplied with NABL certificate of calibration traceable to National standards
- Graduations in amber enamel
- Sturdy hexagonal base prevents roll-over and ensures greater stability



Product Code	Capacity ml	Graduation Interval ml	Tolerance ± ml	Quantity Per Case	Price / Piece ₹
2010005	5	0.1	0.05	1	1555.00
2010006	10	0.2	0.10	1	1525.00
2010009	25	0.5	0.25	1	1775.00
2010012	50	1	0.50	1	2100.00
2010016	100	1	0.50	1	2375.00
2010018	150*	2	1	1	3185.00
2010021	250	2	1	1	3595.00
2010024	500	5	2.5	1	4890.00
2010029	1000	10	5	1	6050.00
2010030	2 L	20	10	1	7725.00

* 150 ml not covered in standard.

Desiccator

BOROSIL® Scientific brand Desiccators are equipped with bodies and covers that have great strength and utility. The body is designed with a streamlined contour that facilitates easy cleaning of the used desiccant. Any desiccant such as sulphuric acid, phosphoric pentoxide, calcium chloride or silica gel may be used in Borosil Scientific brand Desiccators. For your convenience, all Borosil Scientific brand Plain Desiccators of the same size have interchangeable covers and bodies. When the ground surface is cleaned and greased, Vacuum type Desiccators hold a vacuum of 500 mm of mercury.



3082 - DESICCATOR SET With Cover & Porcelain Plate

- Complies with IS 6128
- Supplied with cover and porcelain plate, plastic knob
- Simple design for drying under atmospheric pressure
- Ground glass flanges
- Plates are positioned on an internal ledge within the base
- Generally used for drying of moist products, and for storage of moisture-sensitive substances

Product Code	Nominal Diameter mm	Approx Volume ml	Approx Flange OD mm	Approx Total Height mm	Quantity Per Case	Price / Piece ₹
3082041	100	120	153	173	1	9675.00
3082042	150	410	213	205	1	11295.00
3082043	200	975	272	272	1	15740.00
3082044	250	1825	333	323	1	20110.00
3082045	300	2555	395	344	1	28285.00

Spare porcelain plate available on request



3083 - VACUUM DESICCATOR SET With Cover & Porcelain Plate

- Complies with IS 6128
- Supplied with with cover having stopcock with PTFE spindle, porcelain plate and plastic knob
- Simple design for drying under atmospheric pressure
- Ground glass flanges
- Plates are positioned on an internal ledge within the base
- Designed for use under vacuum
- Generally used for drying of moist products, and for storage of moisture-sensitive substances

Product Code	Nominal Diameter mm	Approx Volume ml	Approx Flange OD mm	Total Height mm	Quantity Per Case	Price / Piece ₹
3083041	100	120	153	173	1	14820.00
3083042	150	410	213	205	1	22295.00
3083043	200	975	272	272	1	25025.00
3083044	250	1825	333	323	1	34740.00
3083045	300	2555	395	344	1	43645.00

Spare porcelain plate and stopcock available on request

3084 - DESICCATOR SET

With Cover & Porcelain Plate **Amber**



- Complies with IS 6128
- Supplied with with cover and porcelain plate, plastic knob
- Simple design for drying under atmospheric pressure
- Ground glass flanges
- Plates are positioned on an internal ledge within the base
- Amber coating to protect light sensitive chemicals
- Generally used for drying of moist products, and for storage of moisture-sensitive substances to protect

Product Code	Nominal Diameter mm	Approx Flange OD mm	Total Height mm	Quantity Per Case	Price / Piece ₹
3084041	100	153	173	1	12790.00
3084042	150	213	205	1	14655.00
3084043	200	272	272	1	18890.00
3084044	250	333	323	1	24000.00
3084045	300	395	344	1	37555.00

Spare cover and porcelain plate available on request

3085 - VACUUM DESICCATOR SET

With Cover & Porcelain Plate, **Amber**



- Complies with IS 6128
- Supplied with with cover having stopcock with PTFE spindle, porcelain plate and plastic knob
- Simple design for drying under atmospheric pressure
- Ground glass flanges
- Plates are positioned on an internal ledge within the base
- Designed for use under vacuum
- Amber coating to protect light sensitive chemicals
- Generally used for drying of moist products, and for storage of moisture-sensitive substances

Product Code	Nominal Diameter mm	Approx Volume ml	Approx Flange OD mm	Total Height mm	Quantity Per Case	Price / Piece ₹
3085041	100	120	153	173	1	23240.00
3085042	150	410	213	205	1	29850.00
3085043	200	975	272	272	1	32625.00
3085044	250	1825	333	323	1	47015.00
3085045	300	2555	395	344	1	52740.00

Spare porcelain plate and stopcock available on request

Steps for Assembling Vacuum Desiccator	STEP 1	STEP 2	STEP 3	STEP 4	STEP 5
	Remove the different parts supplied with the Desiccator <ul style="list-style-type: none"> • Bottom • Lid • Porcelain plate • Stop cock 	Place the porcelain plate in the bottom part of the desiccator	Place the lid over it	Remove the blue knob from the lid and fit the stopcock in blue knob	Screw the blue knob along with the stopcock on the lid Connect the desiccator to a vacuum source (pressure 1 bar) with a rubber tube.

Dishes

BOROSIL Scientific brand Dishes are designed to fulfil your wide-ranging needs - Crystallizing, Evaporating, Drying, Storing, Petri Dishes for culture, assay and micro-biological works. All **BOROSIL Scientific** brand Dishes are safe, durable and economical.

BOROSIL Scientific brand Dishes are inert, can be sterilised and remain clear even after repeated use and washing. With each subsequent use, the cost per Dish decreases.

Made from 3.3 Low Expansion Borosilicate Glass



3140 - CRYSTALLIZING DISHES

- Reinforced and fire-polished rims reduce chipping
- Large labelling field for easy marking
- Very high resistance to chemicals and thermal shocks
- Ideal for crystallization and in hot/ice baths

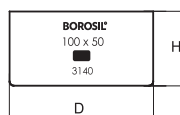

Product Code	Approx O.D. x Height mm	Approx Capacity ml	Quantity Per Case	Price / Piece ₹
3140077	100 x 50	330	10	595.00
3140081	150 x 75	1150	10	1040.00
3140086	190 x 100	2500	4	1725.00



3160 - PETRI DISHES (3.3 Borosilicate)

- Made of 3.3 low expansion borosilicate glass
- Complies with IS 2626
- These dishes are clear and withstand repeated sterilisation cycles (wet or dry)
- Beaded edges impart greater mechanical strength
- Specially formed to ensure even wall thickness and consistent optical performance
- Ideal culture vessel for microbiology and plant tissue culture applications

Product Code	Size mm	LID Approx I.D. (D1) x Height (H1) mm	Bottom Approx O.D. (D2) x Height (H2) mm	Quantity Per Case	Price / Piece ₹
3160065	50 x 17	53 x 15	50 x 17	100	235.00
3160072	80 x 17	83 x 15	80 x 17	100	300.00
3160077	100 x 17#	103 x 15	100 x 17#	100	355.00
3160081	150 x 20	153 x 17	150 x 20	40	870.00
3160087	200 x 20	203 x 20	200 x 20	10	1870.00

Not covered in standard

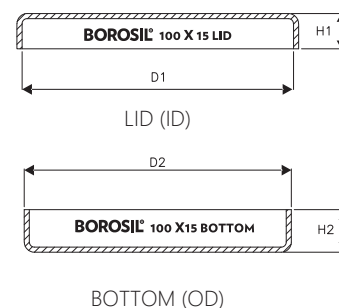

3165 - S LINE PETRI DISHES

- Made of sodalime glass
- S-Line petri dishes with durable white enamel printing - with lid and bottom mentioned on it
- Helps in quick identification of the lid and the bottom while sorting and pairing the petri dishes during use
- Optically clear and bubble free for making critical observations
- Flat inner surface for uniform distribution of media
- Ideal culture vessel for microbiology and plant tissue culture applications

Product Code	Size mm	LID Approx I.D. (D1) x Height (H1) mm	Bottom Approx O.D. (D2) x Height (H2) mm	Quantity Per Case	Price / Piece ₹
3165065	50 x 12	46 x 8	44 x 12	100	110.00
3165072	80 x 15	76 x 12	74 x 15	100	125.00
3165A75	90 x 15	86 x 12	84 x 15	100	125.00
3165077	100 x 15	96 x 12	94 x 15	100	125.00
3165A77	100 x 20	96 x 15	94 x 20	100	195.00
3165081	150 x 25	143 x 18	141 x 25	40	300.00
3165087	200 x 30	195 x 24	192 x 30	10	630.00

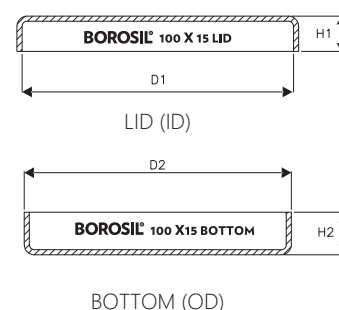

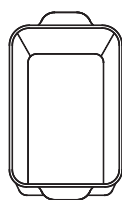

3170 - DRYING TRAYS

- Made with a heavy wall, withstand hot air or steam sterilization
- Facilitates paper chromatography
- Dimensions are approximate, representing the inside

Product Code	Approx Dimension mm	Approx Capacity ml	Quantity Per Case	Price / Piece ₹
3170044	320 x 180 x 51	1500	5	750.00
3170043	350 x 200 x 58	2400	5	1050.00
3170042	386 x 217 x 63	3000	5	1455.00
3170041	404 x 257 x 61	3500	5	1745.00

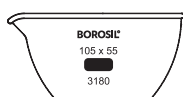

3180 - FLAT BOTTOM EVAPORATING DISHES

With Spout

- Withstands repeated sterilisation (Wet or dry)
- Designed with a spout to facilitate clean pouring
- Very high resistance to chemicals and thermal shocks
- Beaded edge give greater mechanical strength
- Ideal for evaporating solvents in hot/ice baths

Product Code	Approx Dimension mm	Approx Capacity ml	Quantity Per Case	Price / Piece ₹
3180072	80 x 45	165	10	515.00
3180078	105 x 55	290	10	725.00
3180081	150 x 80	855	10	1345.00
3180087	200 x 100	1790	8	2480.00

S LINE

Petri Dishes

Culture vessel for

- Microbial applications
- Plant tissue culture applications



Distilling Apparatus

Most of the distillation equipment required in an average laboratory can be constructed using standard Borosil components. Distillation assemblies for specific applications are available as complete units, as listed herein.

Made from 3.3 Low Expansion Borosilicate Glass

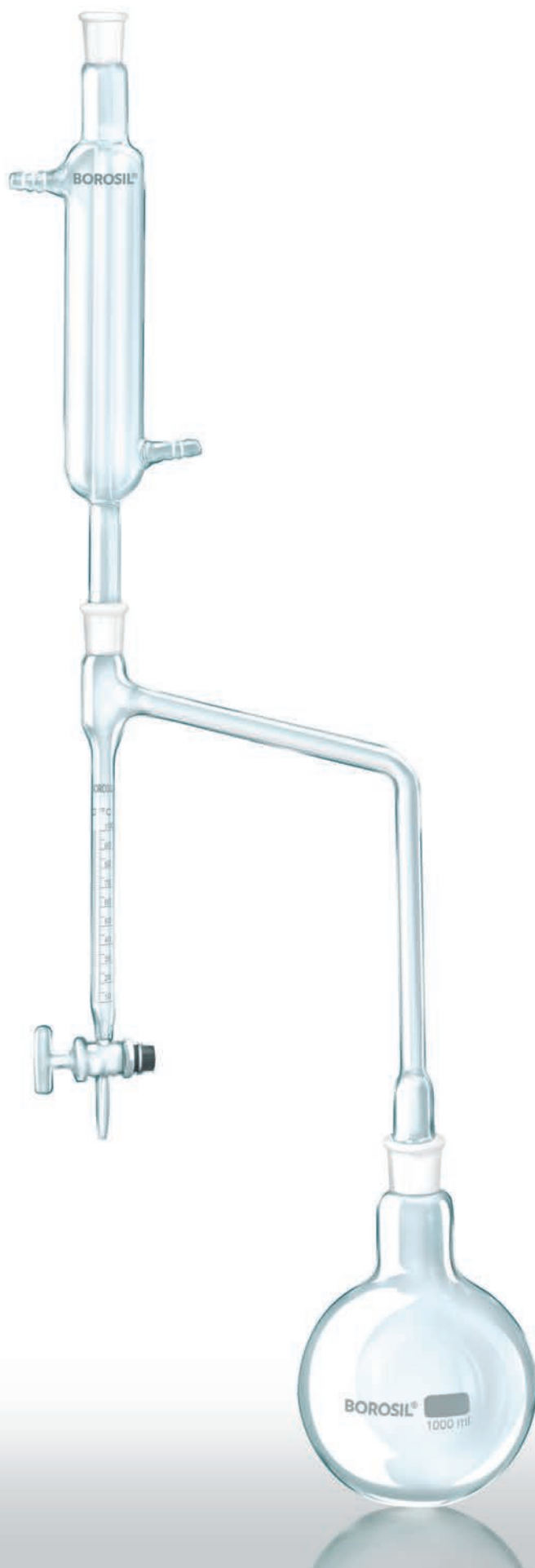

3340-DISTILLING APPARATUS

With Graham Condenser And Interchangeable Joints

- Ideal for determining nitrogen in organic compounds
- Digestion and distillation stages can be performed in this apparatus
- The inlet tube allows permanganate solution to be introduced after distillation
- Large labelling field for easy marking

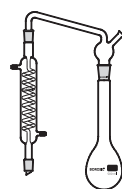

Product Code	Capacity ml	Quantity Per Case	Price / Piece ₹
3340024	500	2 Set	4330.00

Spare parts available on request



3360-DISTILLING APPARATUS

With Graham Condenser, Interchangeable Joints and Stopper

- Ideal for batch production of high purity distilled water
- General purpose Batch Distillation Assembly equipped
- with an interchangeable stoppered neck that facilitates addition
- The Flask has a flat base with a delivery tube on the side

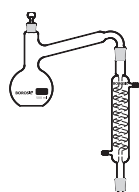

Product Code	Capacity ml	Condenser Jacket mm	Inter-changeable Joint	Quantity Per Case	Price / Piece ₹
3360024	500	200	19 / 26	2 Set	4335.00

Spare parts available on request



3380- DISTILLING APPARATUS

with Friedrichs Condenser, Interchangeable Joint and Stopper

- Ideal for batch production of high purity distilled water
- With Friedrich's Spiral Condenser for higher distillation rates
- General purpose Batch Distillation Assembly equipped with an interchangeable stoppered neck that facilitates addition
- The Flask has a flat base with a delivery tube on the side

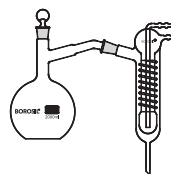

Product Code	Capacity ml	Interchange-able Joint	Quantity Per Case	Price / Piece ₹
3380030	2000	24 / 29	1 Set	5935.00

Spare parts available on request



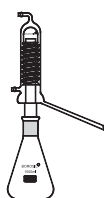

3440-DISTILLING APPARATUS with Friedrichs Condenser, Interchangeable Joint

- Compact
- A compact distillation assembly with specially designed Friedrich's Condensers
- This Condenser is designed with vapour tubing rising at
- A 1000 ml Erlenmeyer Flask is provided with an interchangeable 34/35 joint

Product Code	Capacity ml	Interchangeable Joint	Quantity Per Case	Price / Piece ₹
3440029	1000	34 / 35	2 Set	5545.00
Spare parts available on request				



3450-ESSENTIAL OIL DETERMINATION APPARATUS (Clevenger Apparatus), As per IS 1797

- Ideal for estimation of **volatile oil that is heavier than water**
- Supplied with a 5 ml Receiver with stopcock, an Oil Separator Tube, a condenser and 1000 ml flask

Product Code	Capacity ml	Quantity Per Case	Price / Piece ₹
3450029	1000	1 Set	9985.00
3450030	2000	1 Set	On request
3450033	5000	1 Set	On request
3450038	10000	1 Set	On request
3450040	20000	1 Set	On request
Spare parts available on request			

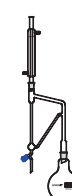

3451-ESSENTIAL OIL DETERMINATION APPARATUS (Clevenger Apparatus)

- Ideal for estimation of **volatile oil that is lighter than water**
- Supplied with a 5 ml Receiver with stopcock, an Oil Separator Tube, a condenser and 1000 ml flask

Product Code	Capacity ml	Quantity Per Case	Price / Piece ₹
3451029	1000	1 Set	9985.00
3451030	2000	1 Set	On request
3451033	5000	1 Set	On request
3451038	10000	1 Set	On request
3451040	20000	1 Set	On request
Spare parts available on request			

3452 - ALCOHOL DISTILLATION UNIT

- Ideal for distilling alcohol in the laboratory to produce the purest grade
- Thorpe's revenue still for purification of ethyl alcohol popularly used in pharmaceutical industries

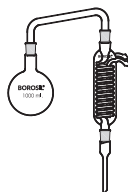

Product Code	Capacity ml	Quantity Per Case	Price / Piece ₹
3452029	1000	1 Set	12410.00

Spare parts available on request



Distilling Apparatus

3454 - R M VALUE APPARATUS

- Ideal for use in dairy industries
- Facilitates the determination of butter fat, and the analysis of oil, fat and waxes

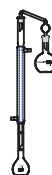

Cat No. 3454A22

Product Code	Capacity ml	Quantity Per Case	Price / Piece ₹
3454022	300	1 Set	3270.00
3454A22*	300	1 Set	4630.00

* As per IS 548 Part I Standard with Rubber shopper

Spare parts available on request

Note : •3454022 with Interchangeable joint
•3454A22 with Rubber shopper.



3602- DEAN STARK DISTILLING APPARATUS

As per IP

- Made of 3.3 borosilicate glass
- Uniform wall distribution of the Flask makes it suitable for heating
- Consists of a graduated 10 ml Receiver with 0.1 ml intervals

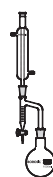

Product Code	Capacity of Receiver Tube ml	Quantity Per Case	Price / Piece ₹
3602005	5	2 Set	3500.00
3602006	10	2 Set	3745.00

Spare parts available on request

Receiver Tube 5ml / 10 ml graduated with 19 / 26 outer joint and 24 / 29 inner joint,
Note: 10 ml receiver tube is graduated from 1 ml to 10 ml in 0.1 ml intervals

Round bottom flask 1000 ml with 24 / 29 outer joint

Liebigh condenser 200 mm with 19 / 26 joint



**ON
DEMAND**

Water Distillation Units

Distillation is the most reliable and cost effective method of generating pure water for laboratory uses like reagents, buffer preparations, pH solutions, rinsing, media preparation, in baths, autoclaves etc.

Distillation generates water free of organic, inorganic impurities from feed water without the need to spend large sums on membranes, resins or filters.

Borosil's ON DEMAND Automatic distillation units empowers the user to set the demand for a set volume of pure water. The unit operates automatically to deliver the set volume and turns itself off.

A system prompted step by step guide assists the user in cleaning the unit for an uninterrupted operation. Safety features for auto cut-off in case of water supply failure or boiler overheating.



Water Distillation Unit

General laboratory applications requiring higher ionic purity, samples & buffer preparations

On Demand Single Distillation Unit (SDU)

Single Stage Distillation units provide automatic working for getting pure water by distillation method capable of removing a wide spectrum of impurities. Raw water is boiled to produce steam which is taken to a condenser where it returns to the liquid state, free of impurity. The impurities remain in the boiler and can be removed periodically with the help of in built descaling or cleaning guide.



Water Distillation Unit

Technical Data & Ordering Information

Model Name	SDU1500	SDU2500	SDU4000
Capacity Distilled Water Output	1.5 LPH	2.5 LPH	4 LPH
Minimum cooling water requirement (Ltr/min)	1	1.5	2
Heater	Quartz	Quartz	Quartz
Boiler	Boro 3.3	Boro 3.3	Boro 3.3
Condenser	Boro 3.3	Boro 3.3	Boro 3.3
Biological Activity	Pyrogen Free	Pyrogen Free	Pyrogen Free
Conductivity S/cm*	<3 × 10 ⁻⁶	<3 × 10 ⁻⁶	<3 × 10 ⁻⁶
Power consumption (kw)	1.5kW	2.5kW	3.5kW
Voltage (V)	230V	230V	230V
Dimensions (L × B × H) in mm		650 × 255 × 440	
HSN Code		84198990	
Ordering Code	BLFRSDU15000000000	BLFRSDU25000000000	BLFRSDU40000000000
Prices / Piece	45,800.00	63,900.00	71,000.00

* Inlet water TDS < 100 ppm

Note: Because of difficulties associated with measurement of the pH value of high purity water and the doubtful significance values obtained, limits for the pH value of grade 1 & grade 2 water have not been specified. Conductivity specified applies for freshly prepared water in absence of Carbon Dioxide at 20° C.

Water Distillation Unit

General laboratory applications requiring higher ionic purity, samples & buffer preparations

On Demand Double Distillation Unit (DDU)

Double Stage Distillation Units provide automatic working for getting pure water by distillation method capable of removing a wide spectrum of impurities. Raw water is boiled to produce steam which is taken to a condenser where it returns to the liquid state, free of impurity. The impurities remain in the boiler and can be removed periodically with the help of in built descaling or cleaning guide.



Technical Data & Ordering Information

Model Name	DDU1500	DDU2500	DDU4000
Capacity Distilled Water Output	1.5 LPH	2.5 LPH	4 LPH
Minimum cooling water requirement (Ltr/min)	1	1.5	2
Heater	Quartz	Quartz	Quartz
Boiler	Boro 3.3	Boro 3.3	Boro 3.3
Condenser	Boro 3.3	Boro 3.3	Boro 3.3
Biological Activity	Pyrogen Free	Pyrogen Free	Pyrogen Free
Conductivity S/cm*	$<3 \times 10^{-6}$	$<3 \times 10^{-6}$	$<3 \times 10^{-6}$
Power consumption (kw)	3 kW	4.4 kW	7 kW
Voltage (V)	230V	230V	230V
Dimensions (L x B x H) in mm	640 x 630 x 520		
HSN Code	84198990		
Ordering Code	BLFRDDU150000000000	BLFRDDU250000000000	BLFRDDU400000000000
Prices / Piece	72,400.00	1,17,400.00	1,27,700.00

* Inlet water TDS < 100 ppm

Note: Because of difficulties associated with measurement of the pH value of high purity water and the doubtful significance values obtained, limits for the pH value of grade 1 & grade 2 water have not been specified. Conductivity specified applies for freshly prepared water in absence of Carbon Dioxide at 20° C.

Quartz Cabinet Distillation

**NEW
PRODUCT**

On Demand Quartz Double Distillation Unit (QCD)

Double Stage Quartz cabinet units with reservoir provide automatic working with safety cut-offs for dry-run/unstable water flow. It also offers dispensing serially or continuously from reservoir storage.



Water
Distillation Unit

Technical Data & Ordering Information

Model Name	QCD 250
Orientation	Vertical
Design	Bench Top Cabinet
Capacity Distilled water Output	2.5LPH
Minimum cooling water requirement (Ltr/min)	2
Dimensions (L*B*H) along with reservoir	730 × 730 × 1020
Heater	Quartz
Boiler	Quartz
Condensor	Quartz
Biological Activity	Pyrogen Free
Conductivity S/cm*	<1 × 10 ⁻⁶
Power consumption (kw)	4.4kW
Voltage (V)	230 V
Dry Run Protection	Yes
On Demand Output	Yes
Storage Mode	Yes
Auto Filling Reservoir	Yes
Dispense rate (ml/min)	900ml
Order Code	BLFRQCD25000000000
HSN Code	84194090
Prices / Piece	2,87,900.00

*1 Inlet water TDS < 100 ppm

Note: Because of difficulties associated with measurement of the pH value of high purity water and the doubtful significance values obtained, limits for the pH value of grade 1 & grade 2 water have not been specified. Conductivity specified applies for freshly prepared water in absence of Carbon Dioxide at 20°C. Conductivity values are affected by temperature and absorbed carbon dioxide quantity along with other contaminants from containers stored.

Water Distillation Unit

Manufactured from quartz, providing quick & continuous purified water with smaller foot print in laboratories.

Mono Quartz Distillation Units (Manual)

These Innovative and compact vertical Distillation Units Made from Pure Silica - Quartz are ideal choice for getting single stage distilled water. It meets the standard of the analytical laboratory where purity of distilled water free from metallic ions and bacteria is important.



Technical Data & Ordering Information

Model Name	3363042	3363033	3363038	3364042	3364033
Capacity Distilled Water Output	2.5 LPH	5 LPH	10LPH	2.5LPH	5LPH
Minimum cooling water requirement (Ltr/min)	1	2	2.5	1	2
Heater	Quartz	Quartz	Quartz	Quartz	Quartz
Boiler	Quartz	Quartz	Quartz	Quartz	Quartz
Condenser	Boro 3.3	Boro 3.3	Boro 3.3	Quartz	Quartz
Biological Activity	Pyrogen Free	Pyrogen Free	Pyrogen Free	Pyrogen Free	Pyrogen Free
Conductivity S/cm*	<3 × 10 ⁻⁶	<3 × 10 ⁻⁶	<3 × 10 ⁻⁶	<3 × 10 ⁻⁶	<3 × 10 ⁻⁶
Power consumption (kw)	2.2 kW	4.4kW	8.8 kW	2.2 kW	4.4 kW
Voltage (V)	230V	230V	440V - 3Phase	230V	230V
HSN Code	841940901				
Ordering Code	BT533363042	BT533363033	BT533363038	BT533364042	BT533364033
Model Prices / Piece	45,300.00	85,800.00	1,96,000	78,200.00	1,50,000.00
Accessory - DAPS Code	3366342	3366333	3366338	3366442	3366433
DAPS Prices / Piece	15,700.00	17,530.00	32,470.00	15,700.00	17,420.00

* Inlet water TDS < 100 ppm

DAPS - The Unit provides for Automatic working of distillation unit by switching off the heaters in case water level falls below the heating coil, thereby safeguarding the heaters. The unit resumes distillation when water level is restored by pushing reset button on front panel. The water level sensor probe works on 12 V and hence is very safe to handle. The unit also comes with Buzzer. DAPS is unique for each model.

Note: Because of difficulties associated with measurement of the pH value of high purity water and the doubtful significance values obtained, limits for the pH value of grade 1 & grade 2 water have not been specified. Conductivity specified applies for freshly prepared water in absence of Carbon Dioxide at 20°C.

Water Distillation Unit

All quartz innovative & compact design offers consistent purified water in two distillation stages

All Quartz Double Distillation Units

Quartz distillation units are manufactured from fused quartz tubes. The exceptionally high chemical purity and very low solubility of this material enables the production of very high performance system. The greatest possible attention has been taken for technical performance, simplicity of use and efficiency.



Water Distillation Unit

Technical Data & Ordering Information

Model Name	3365041	3365042	3365033
Capacity Distilled Water Output	1.5 LPH	2.5 LPH	5 LPH
Minimum cooling water requirement (Ltr/min)	1	2	2.5
Heater	Quartz	Quartz	Quartz
Boiler	Quartz	Quartz	Quartz
Condenser	Quartz	Quartz	Quartz
Biological Activity	Pyrogen Free	Pyrogen Free	Pyrogen Free
Conductivity S/cm*	<1 × 10 ⁻⁶	<1 × 10 ⁻⁶	<1 × 10 ⁻⁶
Power consumption (kw)	3 kW	4.4kW	8.8 kW
Voltage (V)	230V	230V	440V - 3Phase
HSN Code		84194090	
Ordering Code	BT533365041	BT533365042	BT533365033
Model Prices / Piece	1,30,100.00	2,28,800.00	4,07,200.00
Accessory - DAPS	3366541	3366542	3366533
DAPS Prices / Piece	16,670.00	17,420.00	32,900.00

* Inlet water TDS < 100 ppm

DAPS - The Unit provides for Automatic working of distillation unit by switching off the heaters in case water level falls below the heating coil, thereby safeguarding the heaters. The unit resumes distillation when water level is restored by pushing reset button on front panel. The water level sensor probe works on 12 V and hence is very safe to handle. The unit also comes with Buzzer. DAPS is unique for each model.

Note: Because of difficulties associated with measurement of the pH value of high purity water and the doubtful significance values obtained, limits for the pH value of grade 1 & grade 2 water have not been specified. Conductivity specified applies for freshly prepared water in absence of Carbon Dioxide at 20°C.

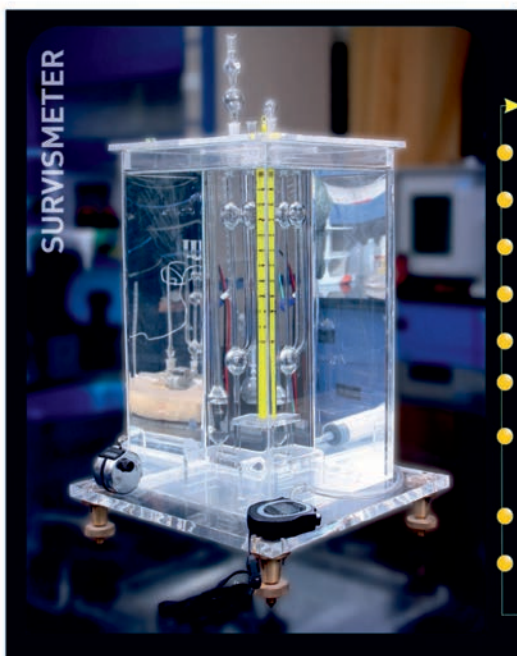

Features

- Multi data device
- Vibration free transparent casing
- Easy handling
- Easy sampling
- Easy data process
- No air contamination because the sample is jacketed within respective bulbs
- Boon for physicochemical characterization of volatile, inflammables, carcinogenic liquids
- Eco-friendly
- Homogeneous Temperature control

Cat. No.	Description	Quantity Per Case	Price ₹
3453	Borosil Mansingh Survismeter For Measurement of surface Tension and Viscosity	1 Set	122850.00

For centuries, surface tension (γ) and viscosity (η) data have been measured using separate instruments, resulting in wastage of time and materials. Made of Borosil Glass material, Borosil Mansingh Survismeter has been designed to measure surface tension, interfacial tension, wetting coefficient, viscosity and friccohesity data to rationalise frictional and cohesive forces, respectively. Friccohesity focuses on a complete friccochemistry of giants and supramolecular mixtures. Borosil Mansingh Survismeter is a state-of-the-art apparatus for measurement of surface tension (± 0.01 mN/m), interfacial tension

(± 0.01 mN/m), viscosity ($\pm 10^{-4}$ mPa.S), wetting coefficient (± 0.01 mPa.cm²) friccohesity ($\pm 10^{-6}$ s/cm) and related physicochemical parameters generated from intramolecular electrostatical shifts.

Borosil Mansingh Survismeter, being a green science TSAD (Trusted Sustainable Analytical Device), measures the above mentioned PCI (PhysicoChemical Indicators), while simultaneously saving 98% of experimental resources, infrastructure and skilled manpower, for interacting and reacting molecular materials.

A breakthrough in laboratory instruments, Borosil Mansingh Survismeter has wider analytical potential for quality control and formulations in material applied sciences. It has unique essential facilities and cutting edge features based on 'On & Off' or '0 & 1' circuitry functional loops.

Fundamentally, Borosil Mansingh Survismeter measures surface tension, interfacial tension, wetting coefficient, viscosity and friccohesity simultaneously of aqueous, non-aqueous, aprotic dipolar, polar, protic polar and non-polar solvents and mixtures within wider ranges.

- The absolute and relative parameters are measured with 95.5% CV (Confidence Variance).
- It works on the theory of R4M4 [Reduce Reuse Recycle Redesign - Multipurpose Multidimensional Multifaceted Multitracking of materials and methods with highly précised and accurate experimental results, along with 100% inhibition of polluting discharges in experimental determinations.

- The parameters measured with Borosil Mansingh Survismeter are highly significant and reliable for quality analysis of pharmaceuticals, biochemicals, cosmetics, agrochemicals, food and beverages, petroleum and oils, polymer and proteins, sol gels, soaps and detergents, inks, colloids, emulsion technology, pesticides, agrochemicals, insecticides, cutting oils, lubricating, viscous, moderately viscous and highly viscous materials.
- It is especially useful for characterising liquid mixtures of biopolymers, supramolecular chemistry, biotechnological processes and molecular interaction engineering of biomolecular devices, tracking interaction molecular forces, water binding capacities and structural changes during processes.
- It explains the features of Intramolecular Multiple Force Theory (IMMFT) applicable to giant supramolecules, dendrimers and biocomplexes used in several adverse temperature and pressure conditions.
- Borosil Mansingh Survismeter is an asset in case of volatile, moderately and highly volatile liquids and mixtures, volatile organic compounds, flammable liquids and carcinogenic materials as the samples are completely jacketed especially for surface tension, interfacial tension and wetting coefficient determinations.

Merits of Borosil Mansingh Survismeter :

- Fast and multipurpose technology
- Eco-friendly and user-friendly
- Reduces fabrication expenditure
- Reduces the need for glass blowing gases, oxygen gas, LPG and manpower
- Reduces emission of heat into the environment
- Ensures safety during transport and maintenance
- Reduces chemicals and solvents greatly
- Contributes to the promotion of green chemistry
- Innovative for youngsters
- No wastage of the sample
- Requires a smaller sample
- Less time required for analysis
- Requires no basic maintenance
- Non-destructive
- Reduces cleaning reagents
- Reduces the number of operational steps in measurement
- Minimises the infrastructure as compared to individual devices

Industrial Applications

Industries such as cosmetics, soaps and detergents, petroleum and oils, pesticides, beverages, textiles, paints, polymers and textiles, paper pulp, ink and dyes, medicines and drugs, food and mineral water, and coolants and lubricants will directly benefit from the use of Borosil Mansingh Survismeter.

Viscometer

**3500-VISCOMETER COLLEGE PATTERN
Oswal 80 -100 Seconds, Uncertified**

Product Code	Size	Nominal Constant	Viscosity Range (CS)	Quantity Per Case	Price / Piece ₹
3500	O	0.001	0.3 - 3	1	2035.00

- Supplied without Certificate

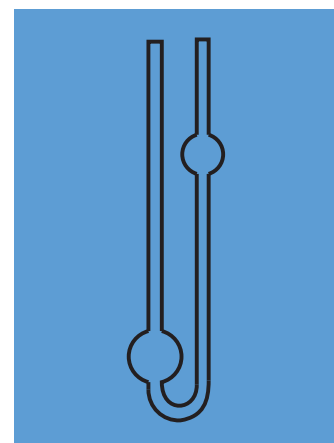

Extractors

Liquid Solid Extraction involves the elution of a solid sample with pure solvent vapour. The sample is held in the Extractor body either directly or in a thimble. The siphoning type of Soxhlet Extractor finds the widest application in laboratory work. Borosil Scientific Soxhlet Extraction Apparatus is available in six sizes. The component parts of the apparatus are provided with interchangeable joints for greater flexibility.



3740 - SOXHLET FOR EXTRACTION APPARATUS

- With interchangeable joints
- Complies with IS 10640
- Designed with a bulb in the siphon tube near the top, to aid the siphoning action
- The vapour tube also protects the siphon tube from accidental damage

Product Code	Capacity ml	Interchangeable Joints		Quantity Per Case	Price / Piece ₹
		Socket	Cone		
3740013	60	34 / 35	24 / 29	5	1065.00
3740016	100	40 / 38	24 / 29	5	1510.00
3740020	200	50 / 42	24 / 29	5	1820.00

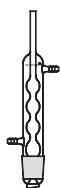
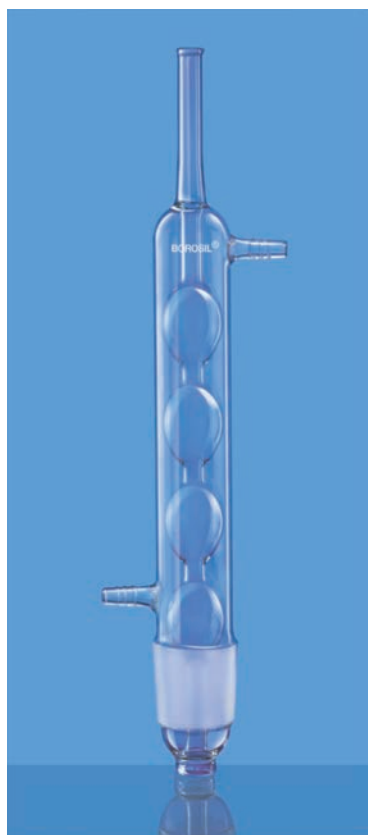

3741 - CONDENSER FOR EXTRACTION APPARATUS

- Greater surface area than the Liebig Condenser owing to a series of bulbs, resulting in higher cooling capacity
- Ideal for laboratory scale refluxing

Product Code	Capacity ml	Interchangeable Joints Cone	Quantity Per Case	Price / Piece ₹
3741013	Small	34 / 35	5	870.00
3741016	Medium	40 / 38	5	1090.00
3741020	Large	50 / 42	5	1575.00

3840 - SOXHLET EXTRACTION APPARATUS SET

- With Interchangeable Joints
- Complies with IS 10640
- Used for separation of the extract from the liquid or solid
- Greater surface area than the Liebig Condenser owing to a series of bulbs, resulting in higher cooling capacity
- This method enables effective separation, with relatively small quantities

Product Code	Capacity ml	Flask Size ml	Quantity Per Case	Price / Piece ₹
3840013	60	150	1	2220.00
3840016	100	250	1	2615.00
3840020	200	500	1	4305.00
3840024	500*	2000	1	15600.00
3840029	1000*	3000	1	23300.00
3840030	2000*	5000	1	39340.00

Spares are available on request

For flask refer Product Code 4100 / 4380 (2000 ml, 3000 ml, 5000 ml)

* Extractor Supplied are with double surface condenser for higher cooling capacity & flange type soxhlet extractors

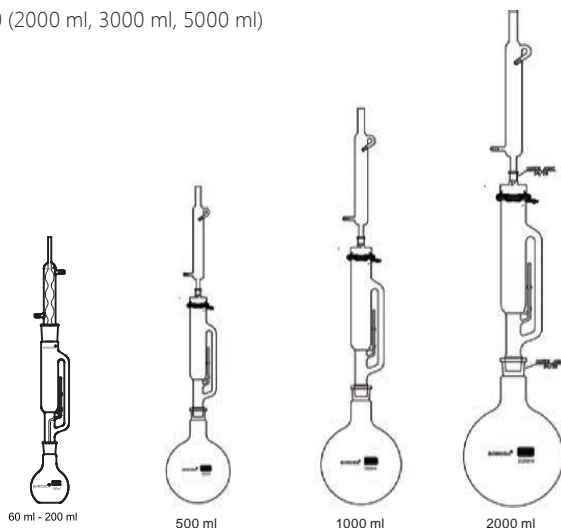

• Extraction Apparatus
• Flasks
• Filtration Products

BOROSIL® Scientific Laboratory Filter Media

Thimbles

Cellulose and Glass Fibre thimbles for accurate and consistent extraction applications.

In technical collaboration with
Hahnemühle



For more details please refer page no. 241

COD Digestion Unit

Open Reflux COD Digesters-Ideal solutions for waste water analysis



Technical Data & Ordering Information

Model Name	COD082	COD152	COD080	COD150
Reflux Type	Open	Open	Open	Open
Positions	08 Position	15 Position	08 Position	15 Position
Capacity	250 ml × 08 tubes	250 ml × 15 tubes	250 ml × 08 tubes	250 ml × 15 tubes
Heating Block	Aluminium			
Temperature Range	Ambient to 180°C			
Temperature Accuracy	±1°C		±10°C	
Display	Front GRP control panel with Graphic LCD		LED	
Graphical representation of time and temp	Yes		No	
Two point factory calibration	Yes			
PID autotune	Yes			
User presets	Yes			
Process Timer	0 - 999 min			
Temperature Control	Yes with Set value and Present value			
Time Control	Yes with Set value and Present value			
Connectivity to Printer	Yes		No	
Connectivity to PC	Yes		No	
Power consumptions	1400W	1800 W	1200W	1600W
Current Consumption	6 A	8 A	6 A	8 A
Unit External Dimensions (W × D × H)	(414 × 414 × 283)mm		(414 × 414 × 283)mm	
HSN Code	84198990			
Ordering Code	BLFACOD 08200000000	BLFACOD 15200000000	BLFACOD 08000000000	BLFACOD 01500000000
Prices / Piece	On Request			

Description	Ordering Code	Pack Size	Prices / Piece
COD air condensers	BLMACND100 CODSAC00	5	7,120.00
COD digestion vessels	BLMATUB100CODSGT20	5	6,340.00

Note : Digestion vessels and air condensers are provided by default with the unit

Fat Determination by Soxhlet Extraction

Delivering classical solutions with modernized approach for fat extraction



Technical Data & Ordering Information

Model Name	SOX012	SOX015	SOX062	SOX065
Positions	1	1	6	6
Flask Capacity (ml)	250	500	250	500
Extractor capacity (ml)	100	200	100	200
Display Timer	1-999 min			
Dimension (W × D × H) mm	200 × 300 × 800		1050 × 300 × 800	
Weight (Kgs)	7		15	
Power (W)	400 W		2400 W	
HSN Code	84198990			
Ordering Code	BLFRSOX 0120000000	BLFRSOX 0150000000	BLFRSOX 0620000000	BLFRSOX 0650000000
Price / Piece	On Request			

Accessories

Description	Ordering Code	Prices / Piece
SOX012 with Stand ASM (Entire assembly without glass parts)	BLAASOX01210000000	16,320.00
SOX015 with Stand ASM (Entire assembly without glass parts)	BLAASOX01510000000	17,280.00
SOX062 with Stand ASM (Entire assembly without glass parts)	BLAASOX06200000001	63,780.00
SOX065 with Stand ASM (Entire assembly without glass parts)	BLAASOX06500000001	73,280.00
SOXHLET 100 ML EXTRACTOR	BLA0SOXEXT10044327	5,000.00
SOXHLET 200ML EXTRACTOR	BLA0SOXEXT20048394	5,280.00
SOXHLET CONDENSER FOR 100ML EXT V2 ACCS	BLA0CON000SOX100V2	6,660.00
SOXHLET CONDENSER FOR 200ML EXT V2 ACCS	BLA0CON000SOX200V2	5,040.00

Flasks

All laboratories need Flasks of different types. **BOROSIL Scientific** offers a wide range of Flasks for a variety of applications such as boiling, culture, distilling, Erlenmeyer, Filtering, Iodine, and Kjeldahl. Choose one to suit your needs.

BOROSIL Scientific brand Flasks are designed to deliver the best combination of thermal shock resistance, physical strength and resistance to chemical attack. They are made so as to withstand the demands of the modern laboratory. Flasks with interchangeable joints are particularly suitable for all glass apparatus assemblies.

BOROSIL Scientific offers the interchangeable joints most commonly specified for a particular capacity. Tube Adaptors Category Nos. 8800 and 8820 can be used to connect the flask with a particular size joint to any other apparatus having a different size joint.

Made from 3.3 Low Expansion Borosilicate Glass



4060 - FLAT BOTTOM FLASK

Narrow Mouth

- Complies with IS 1381 (Part - I), ISO 1773
- Uniform wall thickness distribution makes these flasks ideal for heating
- All sizes have a durable matt-finished enamelled area for marking



Product Code	Capacity ml	Approx O.D. x Height mm	Approx Neck O.D. mm	Quantity Per Case	Price / Piece ₹
4060009	25**	42 x 90	20	50	120.00
4060012	50	51 x 90	26	50	140.00
4060016	100	64 x 105	26	80	150.00
4060018	150**	75 x 132	28	10	170.00
4060021	250	85 x 140	34	80	180.00
4060022	*300**	88 x 160	24	20	265.00
4060024	500	105 x 165	34	40	295.00
4060029	1000	131 x 190	42	20	460.00
4060030	2000	166 x 230	50	2	875.00
4060031	3000	186 x 300	50	4	2480.00
4060033	5000	224 x 320	58	2	3640.00
4060034	6000	236 x 315	65	1	5260.00
4060038	10000	279 x 360	65	1	8495.00
4060040	20000	350 x 495	78	1	14145.00

* Suitable for use in Polenske Apparatus

** Not covered in standards

4100 - FLAT BOTTOM FLASK

Narrow Mouth, Short Neck With I/C Joint

- Uniform wall thickness distribution makes these Flasks ideal for heating
- All sizes have a durable matt-finished enamelled area for marking
- Equipped with interchangeable joint
- The flat base ensures that the Flask can be placed down even without the supporting ring



Product Code	Capacity ml	Interchangeable Joint	Approx Height mm	Quantity Per Case	Price / Piece ₹
4100018	150	24 / 29	115	5	280.00
4100021	250	24 / 29	130	5	300.00
4100024	500	24 / 29	160	5	445.00
4100029	1000*	34 / 35	288	2	565.00
4100030	2000*	34 / 35	321	2	1010.00
4100031	3000*	34 / 35	345	2	2755.00
4100033	5000*	34 / 35	381	2	4475.00

* These are specific flasks with long neck 34/35 joint used in jewellery manufacturers



4260 - ROUND BOTTOM FLASK Narrow Mouth

- Complies with IS 1381 (Part I), ISO 1773
- Uniform wall thickness distribution makes these Flasks ideal for heating
- All sizes have a durable matt-finished enamelled area for marking

Product Code	Capacity ml	Approx O.D. x Height mm	Approx Neck O.D. mm	Quantity Per Case	Price / Piece ₹
4260009	25**	42 x 90	22	50	120.00
4260012	50	51 x 95	26	70	135.00
4260016	100	64 x 110	26	50	150.00
4260018	150**	75 x 137	28	10	170.00
4260021	250	85 x 143	34	80	170.00
4260024	500	105 x 168	34	40	295.00
4260029	1000	131 x 200	42	20	400.00
4260030	2000	166 x 240	51	2	885.00
4260031	3000	187 x 305	50	2	2435.00
4260033	5000	224 x 350	58	2	3600.00
4260034	6000	236 x 330	65	1	4700.00
4260038	10000	279 x 380	65	1	7520.00
4260040	20000	350 x 505	78	1	14085.00

** Not covered in standards

LABQUEST
BY BOROSIL®

Still and Stirred Oil Baths

The oil bath is Constructed entirely of stainless steel, the Precision Oil Bath provides controlled heating up to 240°C. It is designed for still and stirred applications, offering a temperature accuracy of +1°C. The bath is insulated for user safety and equipped with overshoot control. Additionally, it can be used with water.

- Made from stainless steel
- Perforated base plate and supplied with lid
- Temperature control of either internal or external with a PT 100 probe
- Cylindrical interior tank
- Small footprint
- Microprocessor PID control
- Available with an inbuilt stirrer option for uniform heat transfer

Call or Write to us

Email id: lab.support@borosil.com
Toll Free Number: 1800 224 551



For more details please refer page no. 268

4265 - DISSOLUTION E-FLASK

Clear, USP, With Certificate

- Designed for dissolution apparatus with side cut, as per USP
- Vessels conforms to all requirements of USP Ch. 711, provided with certificate
- Smooth hemispherical base with no flaws or defects, straight sides and a flat flange
- Graduated in intervals of 50 ml
- Ideal for Dissolution Apparatus for determining the dissolution characteristics of drugs in capsules and tablets



Product Code	Capacity ml	Approx O.D. x Height mm	Quantity Per Case	Price / Piece ₹
4265029	1000	131 x 173	6	3410.00

4267 - DISSOLUTION E-FLASK

Amber, USP, With Certificate

- Designed for dissolution apparatus with side cut, as per USP
- These vessels conform to all the requirements of USP Ch. 711, provided with certificate
- Smooth hemispherical base with no flaws or defects, straight sides and a flat flange
- Graduated in intervals of 50 ml
- Ideal for dissolution apparatus for determining the dissolution characteristics of drugs in capsules and tablets
- Coloured in Amber to protect light-sensitive material
- The Amber colour is applied only to the external surface to prevent contamination with the testing material

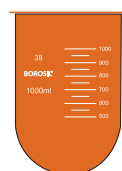

Product Code	Capacity ml	Approx O.D. x Height mm	Quantity Per Case	Price / Piece ₹
4267029	1000	131 x 173	6	6145.00

4270 - DISSOLUTION D-FLASKS

- Designed for Dissolution Apparatus without side cut, with silicon ring, as per USP
- Vessels conforms to all requirements of USP Ch. 711, provided with certificate
- Smooth hemispherical base with no flaws or defects, straight sides and a flat flange
- Graduated in intervals of 50ml
- Ideal for determining the dissolution characteristics of drugs in capsules and tablets

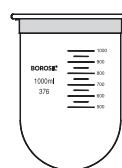

Product Code	Capacity ml	Approx O.D. x Height mm	Quantity Per Case	Price / Piece ₹
4270029	1000	132 x 168	6	12525.00



4315 - PEAR SHAPE FLASK With I/C Joint

- The conical shape makes them ideal for small scale reaction
- Large labelling field

Product Code	Capacity ml	Interchangeable Joint Size	Quantity Per Case	Price / Piece ₹
4315005	5	10 / 19	10	205.00
4315105	5	14 / 23	10	205.00
4315006	10	10 / 19	10	220.00
4315106	10	14 / 23	10	220.00
4315009	25	14 / 23	5	240.00
4315012	50	14 / 23	10	280.00

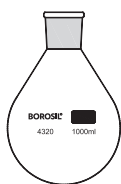

4320 - ROTARY EVAPORATOR FLASK With I/C Joint

- Rota Vapour Flasks are used along with Rotary Evaporators
- Ideal for heating sensitive solvent solute combinations
- Facilitate the extraction of key components like odour, oil, drugs, natural extract and fragrance

Product Code	Capacity ml	Interchangeable Joint Size	Quantity Per Case	Price / Piece ₹
4320112	50	24 / 29	2	1240.00
4320012	50	29 / 32	2	1310.00
4320116	100	24 / 29	2	1965.00
4320016	100	29 / 32	2	2100.00
4320121	250	24 / 29	2	2960.00
4320021	250	29 / 32	2	3120.00
4320124	500	24 / 29	2	3385.00
4320024	500	29 / 32	2	3515.00
4320129	1000	24 / 29	2	5980.00
4320029	1000	29 / 32	2	6120.00
4320130	2000	24 / 29	2	7710.00
4320030	2000	29 / 32	2	7905.00

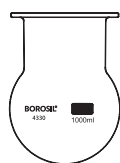

4330 - REACTION VESSEL FLASK Wide Mouth With Flange

- These flasks have a spherical body with a neck of inner diameter 4 inches (approx 100 mm)
- The top is finely ground to ensure a leak-resistant fit with the cover

Product Code	Capacity ml	Approx Height mm	Quantity Per Case	Price / Piece ₹
4330029	1000	170	2	2290.00
4330030	2000	205	2	3105.00
4330033	5000	260	2	6490.00
4330038	10000	335	1	13705.00
4330040	20000	400	1	23580.00

4331 - LID FOR REACTION VESSEL FLASK

(Cat. No. 4330)

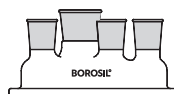

- Lids can be used with all of the above capacities of REACTION VESSEL FLASK (CAT. NO. 4330)

Product Code	Interchangeable Joint Size					Quantity Per Case	Price / Piece ₹
	Centre	Parallel	Side 50°	Side 10°	Side 15°		
4331Z97	19 / 26	19 / 26	24 / 29	19 / 26	-	2	5110.00
4331Z98	19 / 26	14 / 23	14 / 23	14 / 23	29 / 32	2	5110.00
4331Z99	29 / 32	14 / 23	14 / 23	14 / 23	29 / 32	2	5110.00



4380 - ROUND BOTTOM FLASK

Narrow Mouth, Short Neck With I/C Joint

- Uniform wall thickness distribution and the round - bottom shape make them ideal for heating
- Generally used in distillation and extraction processes
- Large labelling field

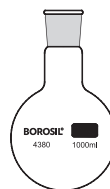

Product Code	Capacity ml	Approx Height mm	Interchangeable Joint	Quantity Per Case	Price / Piece ₹
4380A05	5	60	14 / 23	10	230.00
4380A06	10	65	14 / 23	10	230.00
4380A09	25	80	14 / 23	10	230.00
4380B09	25	77	19 / 26	10	240.00
4380A12	50	95	14 / 23	5	240.00
4380B12	50	95	19 / 26	5	240.00
4380C12	50	95	24 / 29	5	240.00
4380D12	50	95	29 / 32	5	240.00
4380E12	50	95	34 / 35	5	240.00
4380A16	100	120	14 / 23	20	240.00
4380B16	100	120	19 / 26	20	240.00
4380C16	100	120	24 / 29	20	240.00
4380D16	100	120	29 / 32	20	240.00
4380E16	100	120	34 / 35	20	240.00
4380A21	250	140	14 / 23	20	305.00
4380B21	250	140	19 / 26	20	305.00
4380C21	250	140	24 / 29	20	305.00
4380D21	250	140	29 / 32	20	305.00
4380E21	250	140	34 / 35	20	305.00
4380A24	500	160	14 / 23	10	435.00
4380B24	500	160	19 / 26	10	435.00
4380C24	500	160	24 / 29	10	475.00
4380D24	500	160	29 / 32	10	450.00
4380E24	500	160	34 / 35	10	450.00
4380A29	1000	190	19 / 26	10	590.00
4380B29	1000	190	24 / 29	10	590.00
4380C29	1000	190	29 / 32	10	590.00
4380D29	1000	190	34 / 35	10	590.00
4380E29	1000	190	45 / 40	10	590.00
4380F29	1000	190	55 / 44	10	560.00
4380A30	2000	230	24 / 29	4	1140.00
4380B30	2000	230	29 / 32	4	1140.00
4380C30	2000	230	34 / 35	4	1140.00
4380D30	2000	230	45 / 40	4	1140.00
4380A31	3000	265	24 / 29	4	3050.00
4380B31	3000	265	29 / 32	4	3050.00
4380C31	3000	265	34 / 35	4	3050.00
4380D31	3000	265	45 / 40	4	3050.00
4380E31	3000	265	55 / 44	4	3050.00
4380A33	5000	300	24 / 29	2	4665.00
4380B33	5000	300	29 / 32	2	4665.00
4380C33	5000	300	34 / 35	2	4665.00
4380D33	5000	300	45 / 40	2	4665.00
4380E33	5000	300	55 / 44	2	4665.00
4380A38	10000	385	34 / 35	1	9415.00
4380B38	10000	385	45 / 40	1	9415.00
4380C38	10000	385	55 / 44	1	9415.00
4380A40	20000	435	55 / 44	1	16295.00



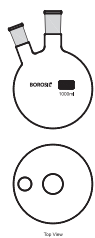

4381 - ROUND BOTTOM FLASK

2 Necks, Angular

- With Interchangeable Joints
- One neck is centred and vertical. The side neck is inclined at an angle of 20° to the vertical neck
- Uniform wall thickness distribution and the round-bottom shape make them ideal for heating
- The shape facilitates uniform heating
- Accessories, thermometer, column, dropping funnels, boiling capillaries, etc., can be fitted depending upon the application
- Generally used in distillation and extraction processes

Product Code	Capacity ml	Interchangeable Joint Size		Quantity Per Case	Price / Piece ₹
		Centre Neck	Side Neck		
4381A16	100	19 / 26	14 / 23	4	350.00
4381B16	100	24 / 29	14 / 23	4	350.00
4381C16	100	24 / 29	19 / 26	4	350.00
4381A21	250	24 / 29	14 / 23	4	465.00
4381B21	250	24 / 29	19 / 26	4	465.00
4381A24	500	24 / 29	14 / 23	4	675.00
4381B24	500	24 / 29	19 / 26	4	675.00
4381A29	1000	24 / 29	14 / 23	2	835.00
4381B29	1000	24 / 29	19 / 26	2	835.00
4381A30	2000	24 / 29	14 / 23	2	1480.00
4381B30	2000	24 / 29	19 / 26	2	1480.00
4381C30	2000	34 / 35	19 / 26	2	1550.00
4381A31	3000	34 / 35	19 / 26	2	3820.00
4381B31	3000	34 / 35	24 / 29	2	3820.00
4381A33	5000	34 / 35	19 / 26	1	5605.00
4381B33	5000	34 / 35	24 / 29	1	5605.00
4381A38	10000	34 / 35	24 / 29	1	10085.00
4381B38	10000	55 / 44	24 / 29	1	10085.00
4381A40	20000	55 / 44	24 / 29	1	16785.00

4382 - ROUND BOTTOM FLASK

2 Necks, Parallel

- With Interchangeable Joints
- Both the necks are vertical. One neck is centred, while the other is the side neck
- Uniform wall thickness distribution and the round-bottom shape make them ideal for heating
- The shape facilitates uniform heating
- Accessories, thermometer, column, dropping funnels, boiling capillaries, etc., can be fitted depending upon the application
- Generally used in distillation and extraction processes



Product Code	Capacity ml	Interchangeable Joint Size		Quantity Per Case	Price / Piece ₹
		Centre Neck	Side Neck		
4382A16	100	19 / 26	14 / 23	4	350.00
4382B16	100	24 / 29	14 / 23	4	350.00
4382C16	100	24 / 29	19 / 26	4	350.00
4382A21	250	24 / 29	14 / 23	4	465.00
4382B21	250	24 / 29	19 / 26	4	465.00
4382A24	500	24 / 29	14 / 23	4	675.00
4382B24	500	24 / 29	19 / 26	4	675.00
4382A29	1000	24 / 29	14 / 23	2	795.00
4382B29	1000	24 / 29	19 / 26	2	835.00
4382A30	2000	24 / 29	14 / 23	2	1415.00
4382B30	2000	24 / 29	19 / 26	2	1480.00
4382C30	2000	34 / 35	19 / 26	2	1480.00
4382A31	3000	34 / 35	19 / 26	2	3820.00
4382B31	3000	34 / 35	24 / 29	2	3820.00
4382A33	5000	34 / 35	19 / 26	1	5605.00
4382B33	5000	34 / 35	24 / 29	1	5605.00
4382A38	10000	34 / 35	24 / 29	1	10085.00
4382B38	10000	55 / 44	24 / 29	1	10085.00
4382A40	20000	55 / 44	24 / 29	1	16790.00

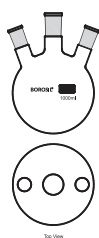

4383 - ROUND BOTTOM FLASK 3 Necks, Angular

- With Interchangeable Joints
- The centred neck is vertical. The two side necks are 180° apart and are inclined at an angle of 20° to the vertical neck
- Uniform wall thickness distribution and round-bottom shape make them ideal for heating
- The shape facilitates uniform heating
- Accessories, thermometer, column, dropping funnels, boiling capillaries, etc. can be fitted depending upon the application
- Generally used in distillation and extraction processes

Product Code	Capacity ml	Interchangeable Joint Size			Quantity Per Case	Price / Piece ₹
		Centre Neck	Side Neck	Side Neck		
4383A16	100	19 / 26	14 / 23	14 / 23	4	490.00
4383B16	100	14 / 23	14 / 23	14 / 23	4	490.00
4383C16	100	24 / 29	14 / 23	14 / 23	4	490.00
4383D16	100	24 / 29	19 / 26	19 / 26	4	490.00
4383A21	250	19 / 26	14 / 23	14 / 23	4	620.00
4383B21	250	19 / 26	19 / 26	19 / 26	4	620.00
4383C21	250	24 / 29	14 / 23	14 / 23	4	620.00
4383D21	250	24 / 29	19 / 26	19 / 26	4	620.00
4383A24	500	19 / 26	14 / 23	14 / 23	4	925.00
4383B24	500	19 / 26	19 / 26	19 / 26	4	925.00
4383C24	500	24 / 29	14 / 23	14 / 23	4	965.00
4383D24	500	24 / 29	19 / 26	19 / 26	4	965.00
4383A29	1000	24 / 29	14 / 23	14 / 23	2	1145.00
4383B29	1000	24 / 29	19 / 26	19 / 26	2	1145.00
4383C29	1000	34 / 35	24 / 29	24 / 29	2	1145.00
4383D29	1000	34 / 35	19 / 26	19 / 26	2	1090.00
4383A30	2000	24 / 29	14 / 23	14 / 23	2	2165.00
4383B30	2000	24 / 29	19 / 26	19 / 26	2	2070.00
4383C30	2000	34 / 35	19 / 26	19 / 26	2	2165.00
4383D30	2000	34 / 35	24 / 29	24 / 29	2	2105.00
4383A31	3000	34 / 35	19 / 26	19 / 26	2	4925.00
4383B31	3000	34 / 35	24 / 29	24 / 29	2	4925.00
4383A33	5000	34 / 35	19 / 26	19 / 26	1	6965.00
4383B33	5000	34 / 35	24 / 29	24 / 29	1	6965.00
4383C33	5000	45 / 40	24 / 29	24 / 29	1	6965.00
4383A38	10000	34 / 35	19 / 26	19 / 26	1	13440.00
4383B38	10000	34 / 35	24 / 29	24 / 29	1	13440.00
4383C38	10000	45 / 40	24 / 29	24 / 29	1	13440.00
4383A40	20000	55 / 44	24 / 29	24 / 29	1	20160.00

4384 - ROUND BOTTOM FLASK

3 Necks, Parallel

- With Interchangeable Joints
- All the three necks are vertical. The two side necks are 180° apart
- Uniform wall thickness distribution and round-bottom shape make them ideal for heating
- The shape facilitates uniform heating
- Accessories, thermometer, column, dropping funnels, boiling capillaries, etc. can be fitted depending upon the application
- Generally used in distillation and extraction processes



Product Code	Capacity ml	Interchangeable Joint Size			Quantity Per Case	Price / Piece ₹
		Centre Neck	Side Neck	Side Neck		
4384A16	100	19 / 26	14 / 23	14 / 23	4	490.00
4384B16	100	14 / 23	14 / 23	14 / 23	4	490.00
4384C16	100	24 / 29	14 / 23	14 / 23	4	490.00
4384D16	100	24 / 29	19 / 26	19 / 26	4	490.00
4384A21	250	19 / 26	14 / 23	14 / 23	4	620.00
4384B21	250	19 / 26	19 / 26	19 / 26	4	620.00
4384C21	250	24 / 29	14 / 23	14 / 23	4	620.00
4384D21	250	24 / 29	19 / 26	19 / 26	4	620.00
4384A24	500	19 / 26	14 / 23	14 / 23	4	940.00
4384B24	500	19 / 26	19 / 26	19 / 26	4	885.00
4384C24	500	24 / 29	14 / 23	14 / 23	4	965.00
4384D24	500	24 / 29	19 / 26	19 / 26	4	965.00
4384A29	1000	24 / 29	14 / 23	14 / 23	2	1195.00
4384B29	1000	24 / 29	19 / 29	19 / 26	2	1145.00
4384C29	1000	34 / 35	24 / 29	24 / 29	2	1145.00
4384D29	1000	34 / 35	19 / 26	19 / 26	2	1090.00
4384A30	2000	24 / 29	14 / 23	14 / 23	2	2070.00
4384B30	2000	24 / 29	19 / 26	19 / 26	2	2070.00
4384C30	2000	34 / 35	19 / 26	19 / 26	2	2070.00
4384D30	2000	34 / 35	24 / 29	24 / 29	2	2105.00
4384A31	3000	34 / 35	19 / 26	19 / 26	2	4925.00
4384B31	3000	34 / 35	24 / 29	24 / 29	2	4925.00
4384A33	5000	34 / 35	19 / 26	19 / 26	1	6965.00
4384B33	5000	34 / 35	24 / 29	24 / 29	1	6965.00
4384C33	5000	45 / 40	24 / 29	24 / 29	1	6965.00
4384A38	10000	34 / 35	19 / 26	19 / 26	1	13440.00
4384B38	10000	34 / 35	24 / 29	24 / 29	1	13440.00
4384C38	10000	45 / 40	24 / 29	24 / 29	1	13440.00
4384A40	20000	55 / 44	24 / 29	24 / 29	1	20160.00



4385 - ROUND BOTTOM FLASK

4 Necks, Angular

- With Interchangeable Joints
- The centred neck is vertical. All the three side necks are inclined at an angle of 20° to the vertical neck
- The two side necks are 180° apart, and a third side neck is at 90° from the other two necks
- Uniform wall thickness distribution and round-bottom shape make them ideal for heating
- The shape facilitates uniform heating
- Accessories, thermometer, column, dropping funnels, boiling capillaries, etc. can be fitted depending upon the application
- Generally used in distillation and extraction processes

Product Code	Capacity ml	Interchangeable Joint Size		Quantity Per Case	Price / Piece ₹
		Centre Neck	Side Neck		
4385A12	50	24 / 29	24 / 29	4	685.00
4385A16	100	24 / 29	14 / 23	4	750.00
4385B16	100	24 / 29	19 / 26	4	785.00
4385A21	250	24 / 29	14 / 23	4	950.00
4385B21	250	24 / 29	19 / 26	4	950.00
4385A24	500	24 / 29	14 / 23	4	1350.00
4385B24	500	24 / 29	19 / 26	4	1350.00
4385C24	500	24 / 29	24 / 29	4	1350.00
4385D24	500	34 / 35	24 / 29	4	1410.00
4385A29	1000	24 / 29	14 / 23	2	1600.00
4385B29	1000	24 / 29	19 / 26	2	1675.00
4385C29	1000	24 / 29	24 / 29	2	1750.00
4385D29	1000	34 / 35	24 / 29	2	1750.00
4385A30	2000	24 / 29	14 / 23	2	2780.00
4385B30	2000	24 / 29	19 / 26	2	2780.00
4385C30	2000	34 / 35	19 / 26	2	2780.00
4385D30	2000	34 / 35	24 / 29	2	2780.00
4385A31	3000	34 / 35	19 / 26	2	6190.00
4385B31	3000	34 / 35	24 / 29	2	6190.00
4385A33	5000	34 / 35	19 / 26	1	8480.00
4385B33	5000	34 / 35	24 / 29	1	8480.00
4385A38	10000	55 / 44	24 / 29	1	15180.00
4385B38	10L	34 / 35	24 / 29	1	15180.00
4385A40	20000	55 / 44	24 / 29	1	22260.00

4386 - ROUND BOTTOM FLASK

4 Necks, Parallel

- With Interchangeable Joints
- All the four necks are vertical. The two side necks are 180° apart and the third neck is at 90° from the other two necks
- Four Necks, Centre Neck and Three Parallel Side Neck, with Interchangeable Joints
- Uniform wall thickness distribution and the round-bottom shape make them ideal for heating
- The shape facilitates uniform heating
- Accessories, thermometer, column, dropping funnels, boiling capillaries, etc. can be fitted depending upon the application
- Generally used in distillation and extraction processes



Product Code	Capacity ml	Interchangeable Joint Size		Quantity Per Case	Price / Piece ₹
		Centre Neck	Side Neck		
4386A12	50	24 / 29	24 / 29	4	685.00
4386A16	100	24 / 29	14 / 23	4	750.00
4386B16	100	24 / 29	19 / 26	4	785.00
4386A21	250	24 / 29	14 / 23	4	950.00
4386B21	250	24 / 29	19 / 26	4	950.00
4386A24	500	24 / 29	14 / 23	4	1290.00
4386B24	500	24 / 29	19 / 26	4	1290.00
4386C24	500	24 / 29	24 / 29	4	1350.00
4386D24	500	34 / 35	24 / 29	4	1410.00
4386A29	1000	24 / 29	14 / 23	2	1675.00
4386B29	1000	24 / 29	19 / 26	2	1750.00
4386C29	1000	24 / 29	24 / 29	2	1750.00
4386D29	1000	34 / 35	24 / 29	2	1750.00
4386A30	2000	24 / 29	14 / 23	2	2650.00
4386B30	2000	24 / 29	19 / 26	2	2780.00
4386C30	2000	34 / 35	19 / 26	2	2650.00
4386D30	2000	34 / 35	24 / 29	2	2780.00
4386A31	3000	34 / 35	19 / 26	2	6190.00
4386B31	3000	34 / 35	24 / 29	2	6190.00
4386A33	5000	34 / 35	19 / 26	1	8480.00
4386B33	5000	34 / 35	24 / 29	1	8480.00
4386A38	10000	55 / 44	24 / 29	1	15180.00
4386B38	10000	34 / 35	24 / 29	1	15180.00
4386A40	20000	55 / 44	24 / 29	1	22245.00

4422 - CULTURE FLASK

Haffikine

- Complies with IS 7183
- The large, flat bottom surface ensures uniform culture growth
- Typically used for the preparation of culture in nutrient media



Product Code	Capacity ml	Approx O.D. x Height mm	Quantity Per Case	Price / Piece ₹
4422031	3000*	245 x 280	2	3990.00
4422032	4000	246 x 310	2	4400.00

*3000 ml not covered in standards



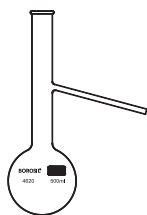

4620 - DISTILLING FLASK

With Side Arm

- Complies with IS 2620
- Uniform wall thickness distribution makes these Flasks ideal for heating
- Suitable for distillation process

Product Code	Capacity ml	Approx O.D. x Height mm	Approx Neck O.D. mm	Quantity Per Case	Price / Piece ₹
4620016	100	65 x 210	22	4	375.00
4620017	*125	69 x 215	22	4	370.00
4620021	250	87 x 230	25	4	615.00
4620024	500	110 x 250	28	4	725.00
4620029	1000	138 x 305	34	4	875.00

* Specification as per the Institute of Petroleum Standard No. IP 123/64



4621 - DISTILLING FLASK

With I/C Joint

- Distilling with I/C joint 19/26 as per ASTM D86

Product Code	Capacity ml	Approx O.D.xHeight mm	Approx Neck I. D.	Inter-changeable Joint	Quantity Per Case	Price / Piece ₹
4621017	125	69 x 218	19	19 / 26	20	580.00

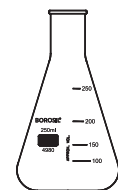

4980 - ERLENMEYER (CONICAL) FLASK

Narrow Mouth, With Rim

- Complies with IS 1381(Part I), DIN / ISO 1773
- Uniform wall thickness distribution makes these flasks ideal for heating
- The conical form makes them suitable for mixing liquids
- The easy-to-read scale and large labelling field facilitate easy marking
- Graduated from 25 ml to 5000 ml

Product Code	Capacity ml	Approx O.D. x Height mm	Approx Neck O.D. mm	Quantity Per Case	Price / Piece ₹
4980006	10*	37 x 60	15	30	110.00
4980009	25	42 x 75	22	40	115.00
4980012	50	51 x 90	22	100	115.00
4980016	100	64 x 105	22	100	120.00
4980017	125*	66 x 110	28	100	140.00
4980018	150*	72 x 124	28	100	145.00
4980021	250	85 x 145	34	40	180.00
4980024	500	105 x 180	34	40	255.00
4980029	1000	131 x 220	42	20	435.00
4980030	2000	166 x 280	52	20	760.00
4980031	3000	187 x 310	50	4	2175.00
4980033	5000	220 x 365	50	2	3360.00

25 ml to 5000 ml Graduated

* Not covered in standards

4981 - ERLNMEYER (CONICAL) FLASK

Long Neck Without Rim

- Complies with IS 1381(Part I), DIN / ISO 1773
- Uniform wall thickness distribution makes these flasks ideal for heating
- Long neck designed for cotton plugs and metal caps
- The conical form makes them suitable for mixing liquids
- The easy-to-read scale and large labelling field facilitate easy marking
- Ideal for microbial culture work

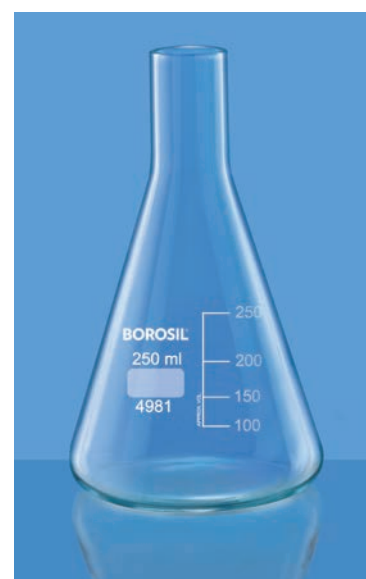
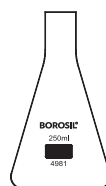

Product Code	Capacity ml	Approx O.D. x Height mm	Approx Neck O.D. mm	Quantity Per Case	Price / Piece ₹
4981021	250	78 x 154	27	10	245.00

4982 - ERLNMEYER (CONICAL) FLASK

Without Rim

- Complies with IS 1381(Part I), DIN / ISO 1773
- Uniform wall thickness distribution makes these flasks ideal for heating
- The conical form makes them suitable for mixing liquids
- Designed without a rim for use in the shaker machine
- The easy-to-read scale and large labelling field facilitate easy marking
- Graduated from 25 ml to 5000 ml

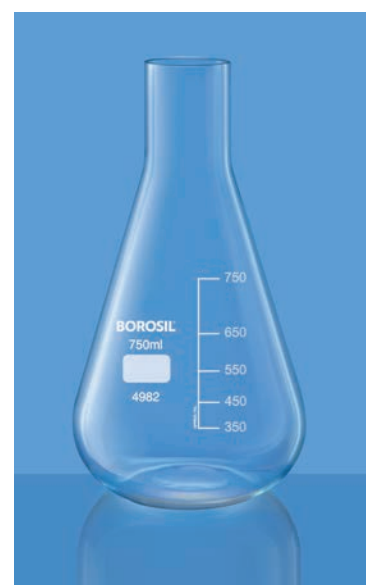
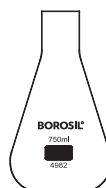

Product Code	Capacity ml	Approx O.D. x Height mm	Approx Neck O.D. mm	Quantity Per Case	Price / Piece ₹
4982027	750	114 x 210	42	10	550.00

Suitable for culture work, designed for use in shaker machine

4989 - ERLNMEYER (CONICAL) FLASK

Narrow Mouth, With Rim, Amber

- Complies with IS 1381 (Part I), DIN / ISO 1773
- Uniform wall thickness distribution makes these flasks ideal for heating
- The conical form makes them suitable for mixing liquids
- The easy-to-read scale and large labelling field facilitate easy marking
- Graduated from 25 ml to 5000 ml
- Coloured in Amber to protect light-sensitive material
- The Amber colour is applied only to the external surface to prevent contamination with the testing material

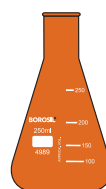

Product Code	Capacity ml	Approx O.D. x Height mm	Approx Neck O.D. mm	Quantity Per Case	Price / Piece ₹
4989016	100	64 x 105	22	10	225.00
4989018	150*	72 x 124	28	10	265.00
4989021	250	85 x 145	34	10	355.00
4989024	500	105 x 180	34	10	565.00
4989029	1000	131 x 220	42	10	955.00

* Not covered in standards

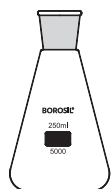

5000 - ERLLENMEYER (CONICAL) FLASK Narrow Mouth, With I/C Joint

- Complies with IS 1381(Part II), DIN / ISO 4797
- Equipped with interchangeable joints
- Uniform wall thickness distribution makes these flasks ideal for heating
- The conical form makes them suitable for mixing of liquids
- The easy-to-read scale and large labelling field facilitate easy marking

Product Code	Capacity ml	Interchangeable Joint	Quantity Per Case	Price / Piece ₹
5000009	25	14 / 23	10	220.00
5000012	50	19 / 26	10	230.00
5000016	100	24 / 29	10	280.00
5000021	250	24 / 29	10	295.00
5000024	500	24 / 29	5	425.00

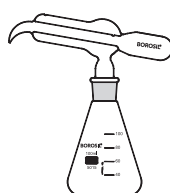

5015 - TILT MEASURE

- Ideal for dispensing fixed volume of liquid
- Easy to use
 - Tilt the unit backward to fill
 - Tilt the unit forward to dispense
- Accuracy + 5% can be achieved

Product Code	Capacity ml	Flask Capacity ml	Quantity Per Case	Price / Piece ₹
5015005	5	100	5	1030.00
5015006	10	250	5	1075.00
5015008	20	250	10	1205.00
5015009	25	250	10	1290.00
5015012	50	250	10	1530.00



5019 - ERLLENMEYER (CONICAL) FLASK Narrow Mouth, With I/C Joint & Glass Stopper, Amber

- Complies with IS 1381 (Part II), DIN / ISO 4797
- Equipped with interchangeable joints
- These flasks can be closed with a glass stopper
- Uniform wall thickness distribution makes these flasks ideal for heating
- While heating stopper should be removed
- The conical form makes them suitable for mixing liquids
- Coloured in Amber to protect light-sensitive material
- The Amber colour is applied only to the external surface to prevent contamination with the testing material

Product Code	Capacity ml	Interchangeable Joint	Quantity Per Case	Price / Piece ₹
5019009	25	14 / 23	10	430.00
5019012	50	19 / 26	10	445.00
5019016	100	24 / 29	20	550.00
5019021	250	24 / 29	20	680.00
5019024	500	24 / 29	10	1110.00

5020 - ERLLENMEYER (CONICAL) FLASK

Narrow Mouth, With I/C Joint & Glass Stopper

- Equipped with interchangeable joints
- These flasks can be closed with a glass stopper
- The conical form makes them suitable for mixing of liquid
- While heating stopper should be removed



Product Code	Capacity ml	Interchangeable Joint	Quantity Per Case	Price / Piece ₹
5020009	25	14 / 23	10	265.00
5020012	50	19 / 26	10	320.00
5020016	100	24 / 29	20	390.00
5020021	250	24 / 29	20	410.00
5020024	500	24 / 29	10	615.00
5020029	1000	29 / 32	10	900.00
5020030	2000	29 / 32	10	1170.00

5021 - ERLLENMEYER (CONICAL) FLASK

With Screw Cap

- Supplied with PP screw cap autoclavable at 121°C
- The conical form makes them suitable for mixing of liquids



Product Code	Capacity ml	Neck Specification	Quantity Per Case	Price / Piece ₹
5021016	100	GL 25	20	340.00
5021018	150	GL 25	20	390.00
5021021	250	GL 45	20	445.00
5021024	500	GL 45	10	575.00
5021029	1000	GL 45	10	1065.00
5021030	2000	GL 45	10	1520.00
5021033	5000	GL 45	2	7145.00

5025 - ERLLENMEYER (CONICAL) FLASK

Baffled Bottom, With Screw Cap

- Supplied with screw cap made of polypropylene, autoclavable at 121°C
- Exhibits four baffled indents to provide consistent agitation and optimum aeration
- Optimum clarity for making critical observations
- Chemically inert and resistance to sodium leaching does not cause any pH changes in the liquid it is holdin
- Ideal culture vessel for microbial culture preparations, enzymatic dissociation of tissues, culturing of suspension cells for biopharma applications, plant cell culturing

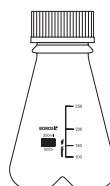

Product Code	Capacity ml	Neck Specification	Quantity Per Case	Price / Piece ₹
5025021	250	GL 45	10	2500.00
5025024	500	GL 45	10	3050.00
5025029	1000	GL 45	10	4295.00
5025030	2000	GL 45	10	5275.00

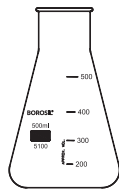

5100 - ERLLENMEYER (CONICAL) FLASK

Wide Mouth

- Complies with IS 1381 /ISO 1773
- Uniform wall thickness distribution makes these flasks ideal for heating
- The conical form makes them suitable for mixing of liquids
- The easy-to-read scale and large labelling field facilitate easy marking
- Designed with a wide neck that makes cleaning and filling easier

Product Code	Capacity ml	Approx O.D. x Height mm	Approx Neck O.D. mm	Quantity Per Case	Price / Piece ₹
5100016	100	64 x 105	34	20	140.00
5100021	250	85 x 142	50	30	190.00
5100024	500	105 x 175	50	20	295.00
5100029	1000	130 x 220	56	10	520.00

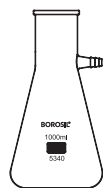

5340 - FILTER FLASK

With Glass Tubulation

- These flasks are blown in special moulds
- The shape is designed to impart maximum mechanical strength
- The neck finish is designed for strength and to ensure good stopper fit
- Ideal for use with Bucher Funnel Category No. 36060 and Gooch Crucible
- No. 32060 with Sintered Discs that have different porosities

Product Code	Capacity ml	Approx O.D. x Height mm	Quantity Per Case	Price / Piece ₹
5340012	50	52 x 86	30	285.00
5340016	100	70 x 105	20	425.00
5340021	250	85 x 155	10	620.00
5340024	500	105 x 185	20	745.00
5340029	1000	135 x 235	10	1130.00
5340030	2000	165 x 270	4	2290.00
5340033	5000	240 x 450	2	8165.00
5340038	10000*	236 x 420	1	14195.00
5340040	20000*	295 x 538	1	24825.00

* These flasks are bottle shaped



5400 - IODINE FLASK

With I/C Glass Stopper

- These flasks are made especially for the determination of Iodine value according to the methods of ASTM D-29
- Supplied Interchangeable Stopper
- Large labelling field for easy marking
- The handle of the stopper projects above the liquid seal, facilitating its removal

Product Code	Capacity ml	Interchangeable Joint Size	Quantity Per Case	Price / Piece ₹
5400016	100	24 / 29	10	320.00
5400021	250	24 / 29	10	405.00
5400024	500	24 / 29	10	510.00

5420 - KJELDAHL FLASK

- Designed with a tooled neck for greater strength and a better stopper fit
- These flasks are specially designed for nitrogen/protein determination as per the Kjeldahl method

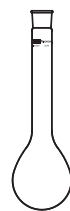

Product Code	Capacity ml	Approx O.D. x Height mm	Quantity Per Case	Price / Piece ₹
5420006	10	30 x 180	10	140.00
5420010	30	40 x 180	10	200.00
5420016	100	61 x 210	10	260.00
5420022	300	82 x 298	10	425.00
5420024	500	103 x 325	10	820.00
5420028	800	116 x 375	10	1000.00



5430 - KJELDAHL FLASK

With I/C Joint

- Designed with a tooled neck for greater strength and better stopper fit
- These flasks are specially designed for nitrogen/protein determination as per Kjeldahl method.
- The flask with 500ml capacity is a part of Ammonia Distilling Apparatus Category No. 3340



Product Code	Capacity ml	Approx O.D. x Height mm	Interchangeable Joint Size	Quantity Per Case	Price / Piece ₹
5430024	500	103 x 325	24 / 29	10	1030.00
5430028	800	116 x 375	24 / 29	10	1140.00



Glass Apparatus as per *Pharmacopoeia*

Arsenic
Apparatus

Methoxy
Apparatus

Sodium Alginate
Assembly

Oxygen Combustion
Flask

Sulphur Dioxide
Assembly

Dean & Stark
Apparatus

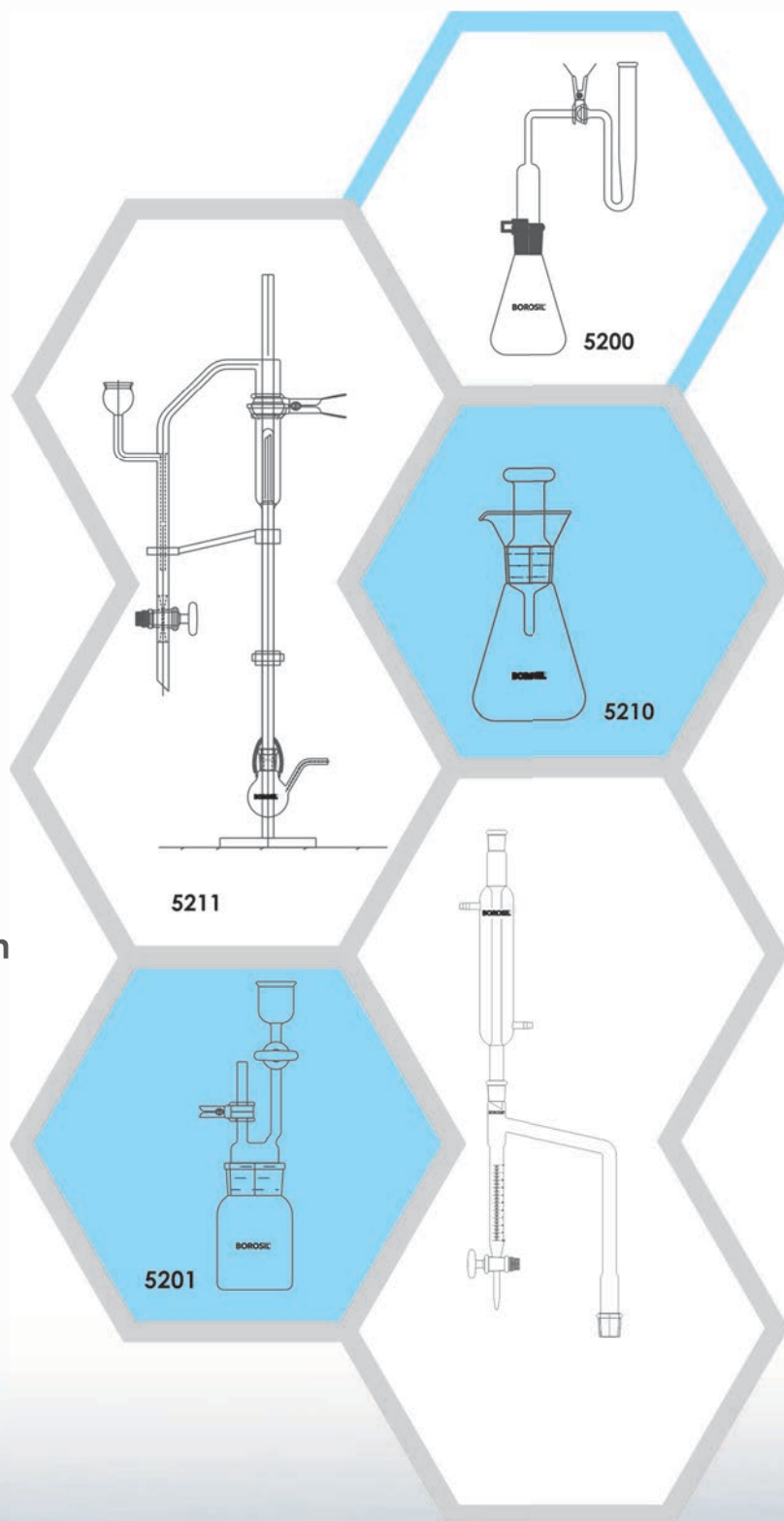

5200 - ARSENIC DETERMINATION APPARATUS AS PER USP

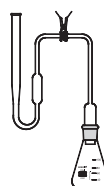

Product Code	Quantity Per Case	Price / Piece ₹
5200001	1	4295.00
Spare parts available on request		



5201 - ARSENIC DETERMINATION APPARATUS GUTZEIT

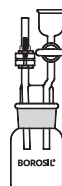

Product Code	Quantity Per Case	Price / Piece ₹
5201001	1	4295.00
Spare parts available on request		



5202 - ARSENIC DETERMINATION APPARATUS AS PER BP

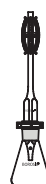

Product Code	Quantity Per Case	Price / Piece ₹
5202001	1	3150.00
Spare parts available on request		





5203 - ARSENIC DETERMINATION APPARATUS AS PER IP

Product Code	Quantity Per Case	Price / Piece ₹
5203001	1	2630.00
Spare parts available on request		

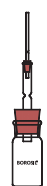

5204 - ARSENIC DETERMINATION APPARATUS AS PER IS

Product Code	Quantity Per Case	Price / Piece ₹
5204001	1	3150.00
Spare parts available on request		

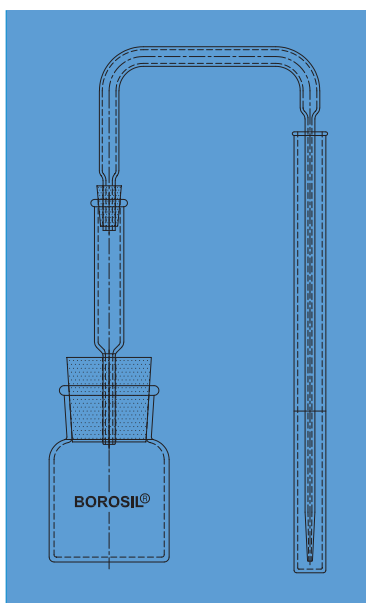

5205 - ARSENIC DETERMINATION APPARATUS AS PER JP

Product Code	Quantity Per Case	Price / Piece ₹
5205001	1	3265.00
Spare parts available on request		

5206 - ARSENIC DETERMINATION APPARATUS AS PER EP

Product Code	Quantity Per Case	Price / Piece ₹
5206001	1	3860.00
Spare parts available on request		

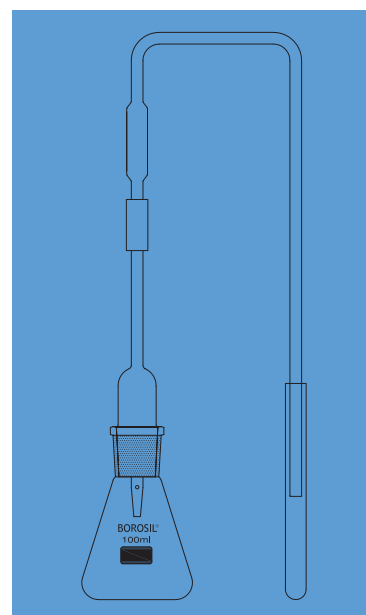

5210 - OXYGEN COMBUSTION FLASK AS PER USP

- Complies to ASTM E205 - 96
- Used for the determination of bromine, chlorine, iodine and sulphur

Product Code	Capacity ml	Quantity Per Case	Price / Piece ₹
5210022	300	1	55470.00
5210024	500	1	60240.00
Spare parts available on request			

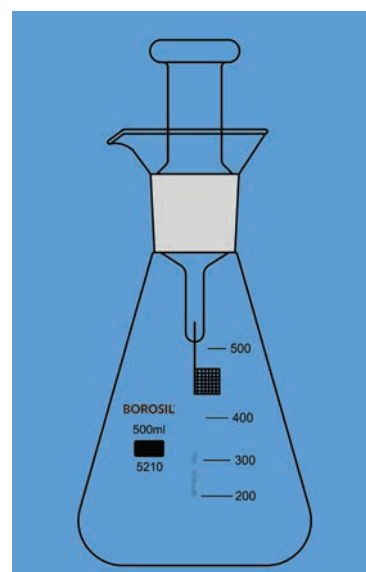

5211 - METHOXY DETERMINATION ASSEMBLY AS PER USP

Product Code	Quantity Per Case	Price / Piece ₹
5211024	1	13270.00
Spare parts available on request		

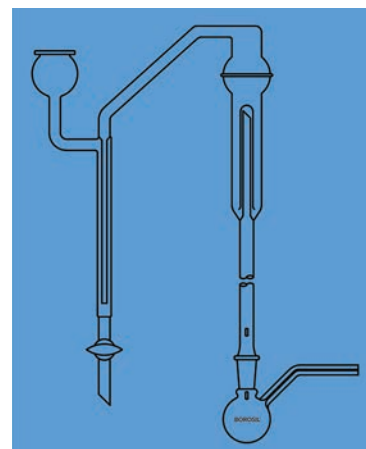

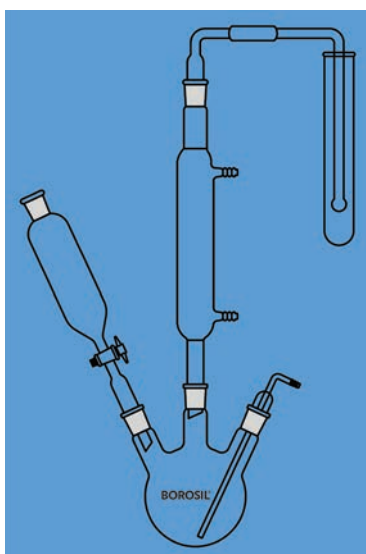

5212 - SULPHUR DI-OXIDE ASSEMBLY AS PER USP

Product Code	Quantity Per Case	Price / Piece ₹
5212024	1	16975.00
Spare parts available on request		

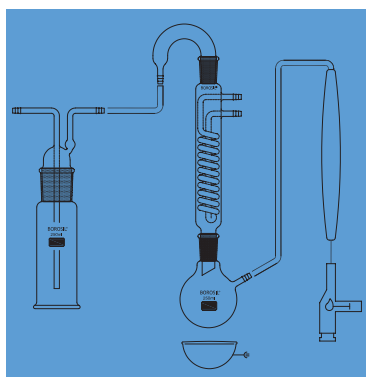

5215 - SODIUM ALGINATE ASSEMBLY AS PER USP

Product Code	Quantity Per Case	Price / Piece ₹
5215021	1	30445.00
Spare parts available on request		

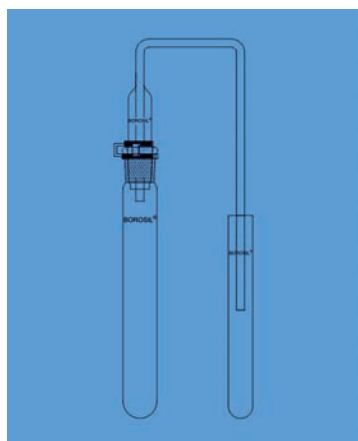

5216 - SODIUM BICARBONATE ASSEMBLY **NEW**

Product Code	Quantity Per Case	Price / Piece ₹
5216001	2 sets	1290

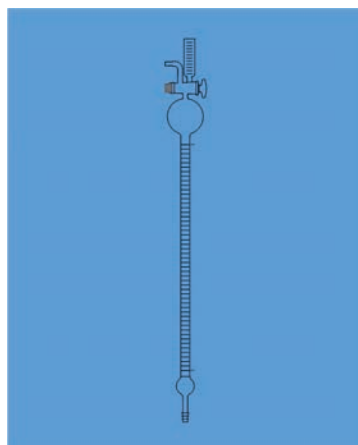

5217 - LUNGE NITROMETER **NEW**

Product Code	Quantity Per Case	Price / Piece ₹
5217001	2 sets	6650

BAFFLED Erlenmeyer Flask

*A cost-effective solution
for your culture preparations*

Ideal culture vessel for

- Microbial culture preparations
- Enzymatic dissociation of tissues
- Culturing of suspension cells for biopharma applications
- Plant cell culturing



BOROSIL[®]
Scientific

BORO PURE
Filtration Products



Made from 3.3 Low Expansion Borosilicate Glass

USP
TYPE I

TYPE I
ASTM
E438
CLASS A

ISO
3585

BOROSIL Scientific offers a complete solution for laboratory filtration applications with **BORO PURE** range of products.

BORO PURE Glass Filter Assembly is easy to clean and 100% autoclavable and reusable. It is made of 3.3 borosilicate glass with a sintered glass filter which is compatible with most of the organic solvents. All glass filter assembly is an environment friendly and cost effective device for filtration.

BORO PURE Filter membrane is a new offering which is a new offering which includes membrane for applications such as HPLC mobile phase filtration, analysis of particulate or biological contaminants, small volume filtration and sterile filtration of media and buffer.



BOROPURE

Filtration Products

Glass Filtration Assembly

is a comprehensive collection of precision-engineered products designed to revolutionize laboratory filtration. From ground joint to GL45 universal adapters, this essential range ensures effortless, high quality filtration, meeting the needs of various applications with utmost ease and efficiency.

**Made from 3.3 Low Expansion
Borosilicate Glass**

USP
TYPE I

TYPE I

ASTM
E438

CLASS A

ISO
3585



5350 - BOROPURE GLASS FILTRATION ASSEMBLY

- Available in two sizes - 47 mm and 90 mm
- Entire assembly consists of:
 1. Glass Funnel - Capacity: 300 ml / 1000 ml
 2. Filter Support Base with sintered glass filter - 47 mm/ 90 mm
 3. Glass Receiver Flask - 500 ml/1000 ml/2000 ml/5000 ml
 4. Aluminium Clamp - 47 mm / 90 mm
- Effective filtration area - 9.6 cm² for 47 mm and 45.5 cm² for 90 mm
- The filter support base design has an integral vacuum connection located above the filtrate drip to prevent contamination of the vacuum line from droplets
- Aluminium spring clamp is anodised for longer life
- Ideal for filtration of HPLC solvents and aqueous mobile phase solutions and buffers

Assembly

Product Code	Filter Support Base Size mm	Glass Funnel Capacity ml	Glass Receiver Flask Capacity ml	Aluminium Clamp mm	Quantity Per Case	Price / Piece ₹
5350024	47	300 ml	500	47	1	18615.00
5350029	47	300 ml	1000	47	1	19275.00
5350030	47	300 ml	2000	47	1	25315.00
5350033	90	1000 ml	5000 ml	90	1	68515.00
5350A29	90	1000 ml	1000 ml	90	1	On request

Spares For 47 MM Filter Assembly

Product Code	Capacity / Size	Description	Price / Piece ₹
5350124	500 ml	Glass Receiver Flask	3940.00
5350129	1000 ml	Glass Receiver Flask	5415.00
5350130	2000 ml	Glass Receiver Flask	12055.00
5350S01	300 ml	Glass Funnel	4820.00
5350S02	47 mm	Filter Support Base	6825.00
5350S03	47 mm	Aluminium Clamp	4000.00

Spares For 90 MM Filter Assembly

Product Code	Capacity /Size	Description	Price / Piece ₹
5350133	5000 ml	Glass Receiver Flask	10030.00
5350229	1000 ml	Glass Receiver Flask	On request
5350233	1000 ml	Glass Funnel	15250.00
5350333	90 mm	Filter Support Base	41425.00
5350433	90 mm	Aluminium Clamp	5515.00

HSN Code: 70179090 (for Assembly as well as spares)

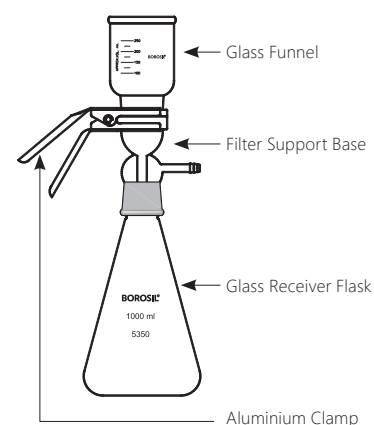



5360 - BOROPURE GLASS FILTRATION ASSEMBLY With Silicone Stopper, 47 mm

- Entire assembly consists of:
 1. Glass Funnel - Capacity: 300 ml
 2. Filter Support Base with sintered glass filter - 47 mm
 3. Glass Receiver Flask - 1000 ml / 2000 ml
 4. Aluminium Clamp - 47 mm
 5. Silicone stopper: size # 8
- Effective filtration area - 9.6 cm² for 47 mm
- The filter support base design has an integral vacuum connection located above the filtrate drip to prevent contamination of the vacuum line from droplets
- Aluminium spring clamp is anodised for longer life
- The filtration base has a silicon stopper
- Facilitates analysis of particulate or biological contamination of vacuum filtering liquid

Assembly

Product Code	Filter Support Base Size mm	Glass Funnel Capacity ml	Glass Receiver Flask Capacity ml	Aluminium Clamp mm	Silicone stopper Size	Quantity Per Case	Price / Piece ₹
5360029	47	300 ml	1000	47	#8	1	17250.00
5360030	47	300 ml	2000	47	#8	1	18430.00

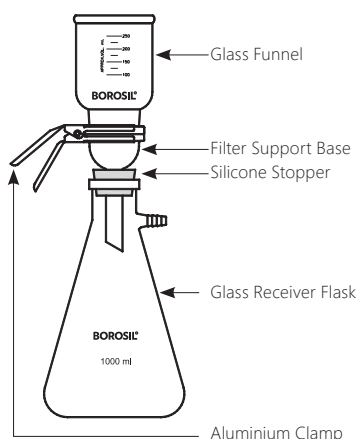

Spares For 47 MM Filter Assembly

Product Code	Capacity / Size	Description	Price / Piece ₹
5360129	1000 ml	Glass Receiver Flask	1140.00
5360130	2000 ml	Glass Receiver Flask	2310.00
5360S01	300 ml	Glass Funnel	4820.00
5360S02	47 mm	Filter Support Base	6825.00
5360S03	47 mm	Aluminium Clamp	4000.00
5360S05	#8	Silicone stopper, MOQ - Pack of 10 nos	435.00

NEW

Looking for Continuous Filtration of solvents?

Without the hassle of refilling the funnel ...

Try our new
Glass Filtration Adapter



Product Code	Description	Size mm	Case Lot Nos	Price / Piece ₹
MISC530	Universal Filtration Adapter, Glass	47	5	On request

Compatible with all glass filtration assembly: 5350, 5360, 5380 and 5385



Scan to watch video

5370 - BOROPURE GLASS MICROFILTRATION ASSEMBLY

With Silicone Stopper, 25 mm

- Entire assembly consists of:
 1. Glass Funnel - Capacity: 15 ml
 2. Filter Support Base with sintered glass filter - 25 mm
 3. Glass Receiver Flask - 125 ml
 4. Aluminium Clamp - 25 mm
 5. Silicone stopper: size #5
- Effective filtration area - 2.2 cm² for 25 mm
- The filter support base design has an integral vacuum connection located above the filtrate drip to prevent contamination of the vacuum line from droplets
- Aluminium spring clamp is anodised for longer life
- The filtration base has a silicon stopper
- Ideal for small volume vacuum filtration for biological analysis or particulate contamination analysis.

Assembly

Product Code	Filter Support Base Size mm	Glass Funnel Capacity ml	Glass Receiver Flask Capacity ml	Aluminium Clamp mm	Silicone stopper Size	Quantity Per Case	Price / Piece ₹
5370017	25	15 ml	125	25	#5	1	9170.00

Spares For 25 MM Filter Assembly

Product Code	Capacity / Size	Description	Price / Piece ₹
5370S01	125 ml	Glass Receiver Flask	3685.00
5370S02	15 ml	Glass Funnel	2240.00
5370S03	25 mm	Filter Support Base	5135.00
5370S04	25 mm	Aluminium Clamp	2820.00
5370S05	#5	Silicone stopper, MOQ - Pack of 10 nos	355.00

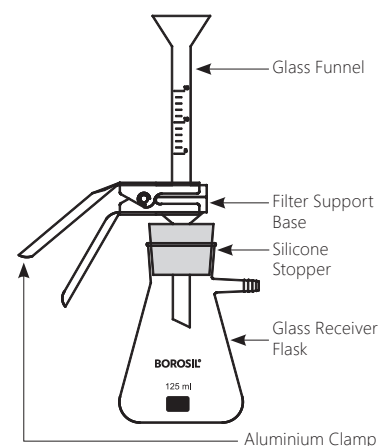

Filtration Products

NEW

Looking for Continuous Filtration of solvents?

Without the hassle of refilling the funnel ...

Try our new
Glass Filtration Adapter



Scan to watch video





5380 - BOROSIL GLASS FILTRATION ASSEMBLY 47 mm, With Bottle

- Entire assembly consists of:
 1. Glass Funnel - Capacity: 300 ml / 1000 ml
 2. Filter Support Base with sintered glass filter - 47 mm / 90 mm
 3. Glass Bottle with PP Screw cap - 1000 ml / 2000 ml / 5000 ml
 4. Aluminium Clamp - 47 mm / 90 mm
- Effective filtration area - 9.6 cm² for 47 mm and 45.5 cm² for 90 mm
- The filter support base design has an integral vacuum connection located above the filtrate drip to prevent contamination of the vacuum line from droplets
- Aluminium spring clamp is anodised for longer life
- The final filtrate will be collected directly in a screw cap bottle and there is no need to transfer the filtrate again into a new container for storage
- Ideal for filtration of HPLC solvents and aqueous mobile phase solutions, sterile filtration of media and buffers

Assembly

Product Code	Filter Support Base Size mm	Glass Funnel Capacity ml	Glass Receiver Bottle Capacity ml	Aluminium Clamp mm	Quantity Per Case	Price per set ₹
5380029	47	300 ml	1000	47	1	17630.00
5380030	47	300 ml	2000	47	1	18200.00
5380033	90	1000 ml	5000	90	1	On Request

Spares For 47 MM Filter Assembly

Product Code	Capacity / Size	Description	Price / Piece ₹
5380129	1000 ml	Glass Receiver Bottle with GL 45 screw cap	3640.00
5380130	2000 ml	Glass Receiver Bottle with GL 45 screw cap	4680.00
5350S01	300 ml	Glass Funnel	4775.00
5380S02	47 mm	Filter Support Base	7490.00
5350S03	47 mm	Aluminium Clamp	3960.00

5385 - BOROPURE GLASS FILTRATION ASSEMBLY

With GL 45 Universal Adapter, 47mm

- The universal adaptor will connect directly to GL 45 bottle
- The final filtrate will be collected directly in a screw cap bottle and there is no need to transfer the filtrate again into a new container for storage
- Entire assembly consists of:
 1. Glass Funnel - Capacity: 300 ml / 1000 ml
 2. Filter Support Base with sintered glass filter - 47 mm
 3. GL 45 Filtration Adaptor
 4. Glass Bottle with PP Screw cap - 1000 ml / 2000 ml
 5. Aluminium Clamp - 47 mm
 6. Effective filtration area - 9.6 cm² for 47 mm
- The GL 45 universal adapter is made of polypropylene and has a vacuum connection and GL 45 threads
- Aluminium spring clamp is anodised for longer life
- Ideal for filtration of HPLC solvents and aqueous mobile phase solutions, sterile filtration of media and buffers

Product Code	Funnel Capacity (ml)	Filtration Support base size (mm)	Filtration adapter	Glass Bottle (ml)	Aluminium Clamp	Qty per case	Price / pc
5385029	300ml	47	GL 45	1000	47	1	18200.00
5385030	300ml	47	GL 45	2000	47	1	18770.00

Spares For 47 MM Filter Assembly

Product Code	Capacity / Size	Description	Price / Piece ₹
1501029	1000 ml	Glass Bottle with GL 45 screw cap	715.00
1501030	2000 ml	Glass Bottle with GL 45 screw cap	1275.00
5350S01	300 ml	Glass Funnel	4775.00
5360S02	47 mm	Filter Support Base	6825.00
5350S03	47 mm	Aluminium Clamp	4000.00
5385S01	GL 45	GL 45 Filtration Adapter	2965.00

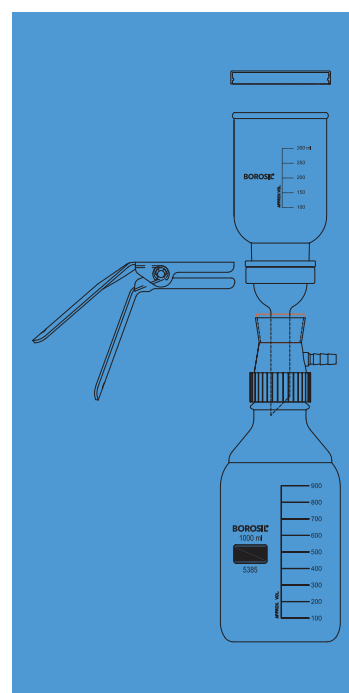

BOROPURE

Filtration Products

Stainless Steel Filtration Assembly

Sturdy and easy to clean SS Filtration assembly for laboratory applications like filtration of HPLC solvents, media, buffers and for microbiological analysis.

The Stainless Steel category offers a range of robust filtration solution designed for durability and efficiency. Explore Vacuum Filtration Assemblies and other sturdy products, carefully crafted to redefine your filtration experience., With compatibility for various applications and exceptional reliability, our Stainless Steel collection ensures superior filtration results you can rely on.



SS Filter Assembly
With Inbuilt Clamp



SS Filter Assembly
With External Clamp



SS Filter Assembly
Spin Lock Type
(No clamp required)



5330 - BOROPURE SS FILTER FUNNEL WITH INBUILT CLAMP, 47MM

- Made of SS 316
- Entire Assembly consists of:
 1. SS Funnel : 300ml / 500ml / 1L with inbuilt Clamp
 2. SS Filter Support Base
 3. SS Support Screen: 47mm, made of SS 316L
 4. Silicone Stopper: Size #8 for 300 ml & 500 ml funnel, #10 for 1L funnel
 5. Silicone Lid
 6. Silicone O ring

Product Code	Description	Funnel Capacity (ml)	Filter Support base diameter (mm)	Filtration Area (cm square)	Quantity per case	Price ₹
5330022	SS Filter Assembly, Inbuilt Clamp, 300ml	300	47	9.6	1	7850.00
5330024	SS Filter Assembly, Inbuilt Clamp, 500ml	500	47	9.6	1	9450.00
5330029	SS Filter Assembly, Inbuilt Clamp, 1000ml	1000	47	9.6	1	27500.00



Membrane not included with funnel

5331 - BOROPURE SS FILTER FUNNEL WITH EXTERNAL CLAMP, 47MM

- Made of SS 316
- Entire Assembly consists of:
 1. SS Funnel : 300ml / 500ml / 1L with external Clamp
 2. SS Filter Support Base
 3. SS Support Screen: 47mm, made of SS 316L
 4. Silicone Stopper: Size #8 for 300 ml & 500 ml funnel, #10 for 1L funnel
 5. Aluminum Clamp: 47mm
 6. Silicone Lid

Product Code	Description	Funnel Capacity (ml)	Filter Support base diameter (mm)	Filtration Area (cm square)	Quantity per case	Price ₹
5331022	SS Filter Assembly, External Clamp, 300ml	300	47	9.6	1	18460.00
5331024	SS Filter Assembly, External Clamp, 500ml	500	47	9.6	1	25250.00
5331029	SS Filter Assembly, External Clamp, 1000ml	1000	47	9.6	1	49250.00



Membrane not included with funnel



Membrane not included with funnel

5332 - BOROPURE SS FILTER FUNNEL WITH SPIN-LOCK TYPE, 47MM

- Made of SS 316
- Entire Assembly consists of:
 1. SS Funnel : 300ml / 500ml / 1L With Spin-lock mechanism
 2. SS Filter Support Base
 3. SS Support Screen: 47mm, made of SS 316L
 4. Silicone Stopper: Size #8 for 300 ml & 500 ml funnel, #10 for 1L funnel
 5. Silicone Lid

Product Code	Description	Funnel Capacity (ml)	Filter Support base diameter (mm)	Filtration Area (cm square)	Quantity per case	Price ₹
5332022	SS Filter Assembly, Spin-lock type, 300ml	300	47	9.6	1	37960.00
5332024	SS Filter Assembly, Spin-lock type, 500ml	500	47	9.6	1	46500.00
5332029	SS Filter Assembly, Spin-lock type, 1000ml	1000	47	9.6	1	63500.00



5333 - BOROPURE SS VACUUM FILTRATION MANIFOLD

- Made of SS 316
- Valves made of PTFE
- Connection: 12mm
- Suitable for PP and Stainless Steel funnels with rubber stopper fittings

Product Code	Description	Stages	Quantity per case	Price ₹
5333003	3 Place SS Filtration manifold	3	1	42120.00
5333006	6 Place SS Filtration manifold	6	1	61500.00



5334 - BOROPURE VACUUM FILTRATION PUMP

- Suitable for use with SS Manifold (5333)
- Oil-free diaphragm based pump
- Compact pump with high flow rate
- Material in contact with the liquid: Silicon, PTFE, SS316L (Connector) and Body Mild steel Powder Coated
- Dimensions: 18x18x12 cm
- Weight: 2.8kg
- Tubing connection: 8mm hose
- Vacuum: 300 mbar, can achieve maximum trans-membrane pressure of 400 mbar and flow rate 5 L/min
- Motor Power: 60w
- Noise: 45db
- Product includes:
- Main unit, Power Adaptor 2.5amp, 230 VAC, Power cord and 3x3 meter silicon tubing



Product Code	Description	Quantity per case	Price ₹
5334001	Vacuum Filtration Pump	1	1,20,000.00

5335 - FILTRATION ASSEMBLY WITH INBUILT PUMP

- Flow rate: 4.5L/min
- Motor Power: 60w 24 VDC
- Tubing connection: 8mm hose
- Material in contact with liquid filtered: Silicon, PTFE, SS 316L
- Compatible with SS, disposable and reusable funnels with suitable adaptor



Scan to watch video



Product Code	Description	No of branches	Dimensions (LxWxH)(cm)	Weight (kg)	Quantity per case	Price ₹
5335001	1 place Filtration Manifold Assembly with inbuilt pump	1	8 × 8 × 6	2	1	On request
5335003	3 place Filtration Manifold Assembly with inbuilt pump	3	40 × 18 × 15	6	1	2,10,000
5335006	6 place Filtration Manifold Assembly with inbuilt pump	6	32 × 6 × 6	13	1	On request



5335ARF

Adapters for Filtration Assembly

Product Code	Description	Quantity per case	Price ₹
5335ARF	Adapter C1 (for reusable PP funnel)	1	8500.00
5335ARB	Adapter C2 (for Rubber stopper filter holder)	1	6000.00
5335ADF	Adapter C3 (for disposable sterile funnel)	1	5000.00
5335AST	Adapter C4 (for silicon tube)	1	4000.00



5335ADF

BORO PURE

Filtration Products

Membrane Filters

BORO PURE Membrane filters are used for applications such as HPLC mobile phase filtration, analysis of particulate or biological contaminants, small volume filtration of media and buffers.



5147 - BOROPURE CELLULOSE NITRATE MEMBRANE

Hydrophilic in nature and biologically inert

High retention and high flow rate

Available in two pore sizes - 0.22 micron and 0.45 micron

Autoclavable at 121°C for 30 mins for sterilization

Recommended for applications like clarification and sterilization of media, reagents and buffers, sterility testing, water testing, product and water microbiology

Tested for : Membrane integrity, Flow rate, Membrane thickness, Heat stability and Microbial Challenge Test



Product Code	Description	Pore size μm	Diameter mm	Membrane /pack Nos	Case lot	Price per pack ₹
514722N	Cellulose Nitrate Membrane, Non- sterile	0.22	47	100	5	1860.00
514745N	Cellulose Nitrate Membrane, Non- sterile	0.45	47	100	5	1860.00

* Sterile membranes available on Request

5247 - BOROPURE GRIDDED CELLULOSE NITRATE MEMBRANE

• Hydrophilic in nature and biologically inert

• High retention and high flow rate

• White membrane with black grids which make the colony counting easier

• Grids do not inhibit the growth of microorganisms

• Available in two pore sizes - 0.22 micron and 0.45 micron

• Autoclavable at 121°C for 30 mins for sterilization

• Recommended for applications like water testing, product and water microbiology

• Tested for : Membrane integrity, Flow rate, Membrane thickness, Heat stability, Microbial Challenge Test and Growth Inhibition



Product Code	Description	Pore size μm	Diameter mm	Membrane /pack Nos	Case lot	Price per pack ₹
524722N	Gridded Cellulose Nitrate Membrane, Non- sterile	0.22	47	100	5	2055.00
524745N	Gridded Cellulose Nitrate Membrane, Non- sterile	0.45	47	100	5	2055.00
524722SE	Gridded Cellulose Nitrate Membrane, ETO sterilized	0.22	47	100	5	2500.00
524745SE	Gridded Cellulose Nitrate Membrane, ETO sterilized	0.45	47	100	5	2500.00

* Sterile membranes available on Request

5347 - BOROPURE NYLON-66 MEMBRANE HPLC Grade

• Hydrophilic in nature and biologically inert

• Wide chemical compatibility and resistant to strong solvents and alcohols

• Available in two pore sizes - 0.22 micron and 0.45 micron

• Autoclavable at 121°C for 30 mins for sterilization

• Recommended for applications like clarification of aqueous and organic HPLC mobile phase solvents, HPLC sample preparations

• Tested for : Membrane integrity, Flow rate, Membrane thickness, Heat stability, Fibre/ particle release and Extractables



Product Code	Description	Pore size μm	Diameter mm	Membrane /pack Nos	Case lot	Price per pack ₹
534722N	Nylon-66 Membrane, Non- sterile	0.22	47	100	5	2155.00
534745N	Nylon-66 Membrane, Non- sterile	0.45	47	100	5	2155.00

For membranes of other diameter and pore sizes, please contact our local sales representative

* Sterile membranes available on Request

• Volumetric Flasks
• Funnels
• Gas Generator
• Jars & Kettles

Volumetric Flask

Volumetric Flasks is a laboratory glassware that is designed to hold a certain volume at a particular temperature and indicates th nominal volume, tolerance, precision class, relevant manufacturing standard etc. **BOROSIL Scientific** Volumetric Flasks are manufactured in a range of sizes that is capable of containing 1ml to 5,000ml of liquid,

it is very important to understand that for analysis which demands high precision, the selection of instruments is very vital In cases where precision analysis is expected, only high accuracy instruments give the desired results. Most sophisticated automatic instruments can deliver high precision results, only if the volumetric ware used to prepare samples is accurate.

- Individually calibrated with automatic calibration process
- Strict quality control through all steps eliminate possible deviations from nominal volume
- Supplied with individual certificate which can be downloaded from our website
- Volumetric Flasks are supplied with plastic or solid glass stopper



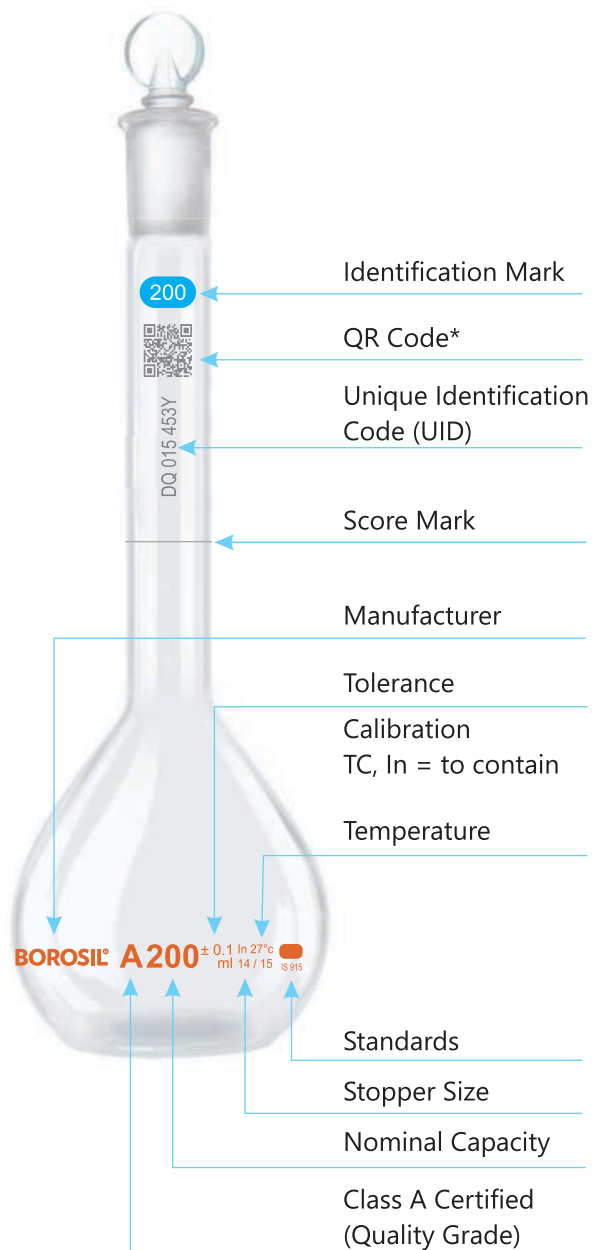

* QR Code marking provided on request.

BOROSIL Scientific Volumetric Flasks are designed to give the best combination of thermal shock resistance, physical strength and resistance to chemical attack. They are made to withstand the demands of the modern laboratory and are particularly suitable for all glass apparatus assemblies.

Made from 3.3 Low Expansion Borosilicate Glass



At **BOROSIL Scientific** we understand that different needs require different solutions. Hence we offer our clients as wide range of flasks, designed to meet their individual requirements, while ensuring optimum quality.

Calibration

- Every Volumetric Flask is calibrated on fully automatic computer controlled calibration machine, eliminating the manual error in reading the meniscus, thereby giving more accurate volume.
- Each Volumetric Flask is individually calibrated and is provided with Unique Identification Number (UID) and supplied with individual Certificate

Printing

- All Volumetric Flasks are printed with permanent amber colour
- The amber Volumetric Flasks are printed with white ceramic enamel
- Printing is done using advanced printing technology and high quality organic enamels and inks to ensure finest printing quality

Bothered filing
hard copies
**of calibration
certificates for long years?**



BOROSIL
Scientific
is right here with a solution

PROUDLY MADE IN 
india

Volumetric Flasks

QR Coded Volumetric Glassware

*For easy certificate download
by simple scanning of glassware*

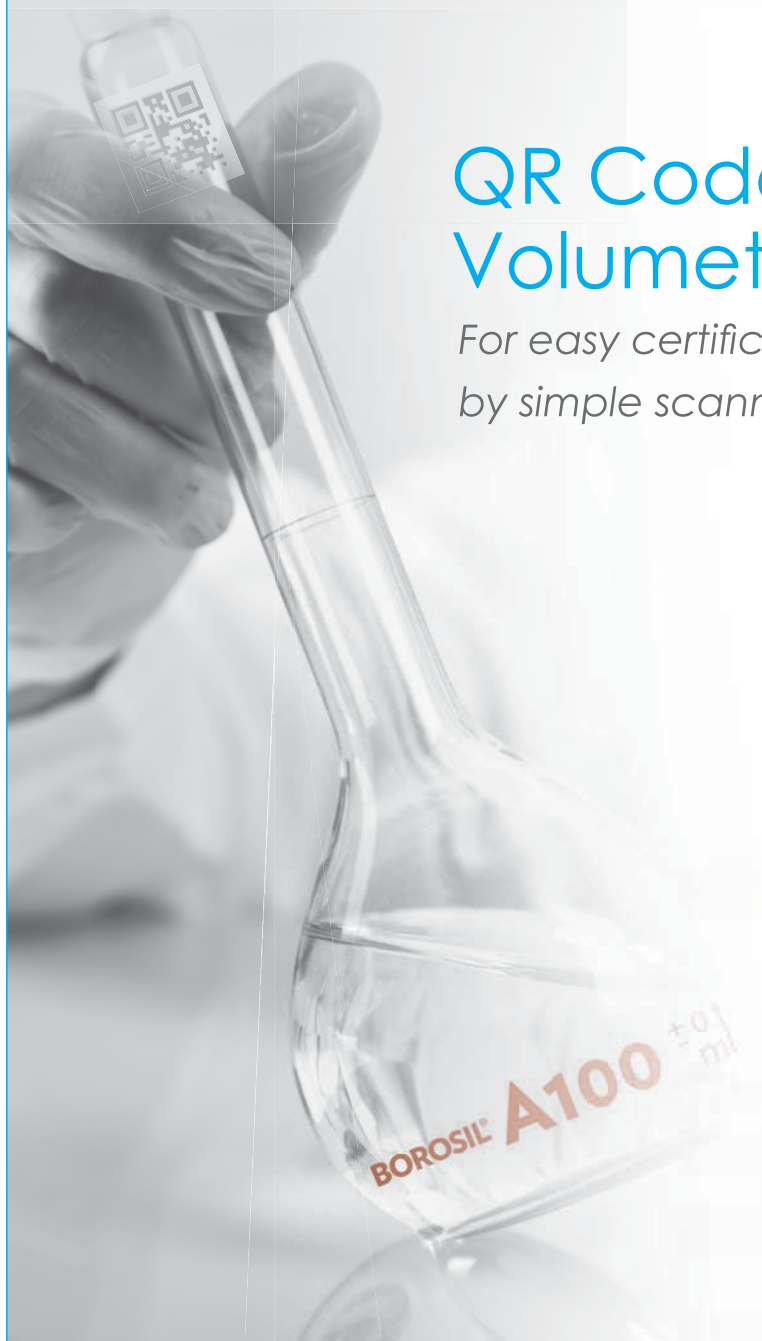

How to download a Calibration Certificate using QR code ?

Borosil Scientific Mobile Application



- ▶ Download the the Borosil app from Android Playstore / iOS App Store
- ▶ Scan the QR code on the Volumetric Flask through your mobile and follow a few simple steps to download the Certificate

Borosil Scientific Website

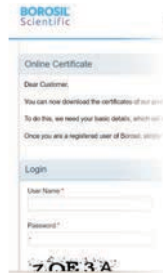

- ▶ Logon to www.borosilscientific.com and enter the product certificate portal
- ▶ Scan the QR code on the Volumetric Flask using a 2D or 3D barcode scanner and follow a few simple steps to download the Certificate

Benefits of using QR coded Glassware

Permanent QR code marking with laser technology

QR code encodes the data required for identification and traceability of individual volumetric ware

- Company name
- Product Code and name
- Unique code
- Nominal and certified Volume
- Calibration details



- No more filing of hard copies of calibration certificates for long years
- Download the certificates by simple scanning of glassware and print as and when required
- Easy download of list of scanned glassware in excel format
- Saves time and hassle involved in maintaining the certificates
- Less usage of paper and better for the environment
- Readiness for audit

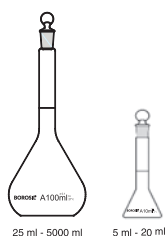

5640 - VOLUMETRIC FLASKS

Class A, Narrow Mouth, Clear, with Individual Calibration Certificate

- Complies with DIN / ISO 1042, Accuracy as per class A
- Supplied with Interchangeable Solid Glass Stopper
- Each flask is marked with individual serial number and supplied with certificate of calibration traceable to National standards
- Amber enamel inscriptions
- Calibrated & certified at 27°C

Product Code	Capacity ml	Tolerance ± ml	Stopper Size	Quantity Per Case	Price / Piece ₹
5640001	1	0.025	7 / 16	5	1165.00
5640002	2	0.025	7 / 16	5	1165.00
5640005	5	0.025	10 / 19 #	5	1050.00
5640006	10	0.025	10 / 19 #	5	910.00
5640008	20	0.04	10 / 19	5	910.00
5640009	25	0.04	10 / 19	5	840.00
5640012	50	0.06	12 / 21	10	795.00
5640016	100	0.10	14 / 23	10	775.00
5640020	200	0.15	14 / 23	10	1095.00
5640021	250	0.15	14 / 23	10	1095.00
5640024	500	0.25	19 / 26	10	1435.00
5640029	1000	0.40	24 / 29	10	2100.00
5640030	2000	0.60	29 / 32	2	3410.00
5640033	5000	1.20	34 / 35	1	14595.00

- 1 ml to 20 ml supplied with trapezoidal shape for better stability
 - # Stopper size as per Borosil Scientific Design

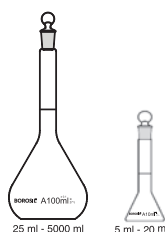

5641 - VOLUMETRIC FLASKS

Class B, Narrow Mouth, Clear

- Complies with DIN / ISO 1042, Accuracy as per class B
- Supplied with interchangeable glass stopper
- Amber enamel inscriptions
- Calibrated at 27°C

Product Code	Capacity ml	Tolerance ± ml	Stopper Size	Quantity Per Case	Price / Piece ₹
5641001	1	0.05	7 / 16	10	385.00
5641002	2	0.05	7 / 16	10	345.00
5641005	5	0.05	10 / 19#	10	320.00
5641006	10	0.05	10 / 19#	10	300.00
5641008	20	0.08	10 / 19	10	300.00
5641009	25	0.08	10 / 19	10	295.00
5641012	50	0.12	12 / 21	10	320.00
5641016	100	0.20	14 / 23	10	350.00
5641020	200	0.30	14 / 23	10	415.00
5641021	250	0.30	14 / 23	10	430.00
5641024	500	0.50	19 / 26	10	600.00
5641029	1000	0.80	24 / 29	10	985.00
5641030	2000	1.20	29 / 32	2	2050.00
5641033	5000	2.40	34 / 35	1	7345.00

- 1 ml to 20 ml supplied with trapezoidal shape for better stability
 - Certified and Calibrated at 27°C
 - # Stopper size as per Borosil Scientific Design

5643 - VOLUMETRIC FLASKS

Class A, Wide Mouth, Clear, with Individual Calibration Certificate

- Complies with DIN / ISO 1042, Accuracy as per class A
- Supplied with Interchangeable Solid Glass Stopper
- Each flask is marked with individual serial number and supplied with certificate of calibration traceable to National standards
- Amber enamel inscriptions
- Specially designed wide mouth for testing bigger diameter tablet without making it in powder form
- Calibrated & certified at 27°C

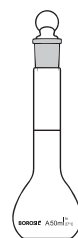

Product Code	Capacity ml	Tolerance ± ml	Stopper Size	Quantity Per Case	Price / Piece ₹
5643005	5	0.04	12 / 21#	5	1045.00
5643006	10	0.04	12 / 21#	5	910.00
5643008	20	0.06	12 / 21	5	920.00
5643009	25	0.06	12 / 21	5	1000.00
5643A09	25*	0.06	14 / 23#	5	980.00
5643012	50	0.10	14 / 23	10	960.00
5643016	100*	0.10	19 / 26	10	1010.00
5643020	200*	0.15	19 / 26	10	1325.00
5643021	250*	0.15	19 / 26	10	1415.00
5643024	500	0.25	24 / 29	10	1585.00
5643029	1000	0.60	29 / 32	10	2185.00

- * Not covered in the standards
- 5 ml to 20 ml supplied with trapezoidal shape for better stability
- # 5 ml & 10 ml (# Stopper size as per borosil scientific design)



5645 - VOLUMETRIC FLASKS

Class A, ASTM, Narrow Mouth, Clear, with Individual Calibration Certificate, Neck size as per ASTM (Bulgy neck)

- Complies fully with ASTM E 288 standards - For both dimensions as well as tolerance
- Supplied with Interchangeable Solid Glass Stopper
- Each flask is marked with individual serial number and supplied with certificate of calibration traceable to National standards
- Amber enamel inscriptions
- Calibrated & certified at 20°C

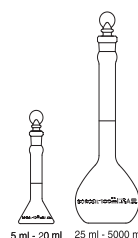

Product Code	Capacity ml	Tolerance ± ml	Stopper Size	Quantity Per Case	Price / Piece ₹
5645005	5	0.02	9	5	1175.00
5645006	10	0.02	9	5	1020.00
5645008	20	0.03	9	5	1025.00
5645009	25	0.03	9	5	940.00
5645012	50	0.05	9	10	895.00
5645016	100	0.08	13	10	880.00
5645020	200	0.10	16	10	1230.00
5645021	250	0.12	16	10	1235.00
5645024	500	0.20	19	10	1625.00
5645029	1000	0.30	22	10	2360.00
5645030	2000	0.50	27	2	3835.00

- 5 ml to 20 ml supplied with trapezoidal shape for better stability
- For Stopper dimensions refer page no. 36





5645D - VOLUMETRIC FLASKS

Class A, USP, Narrow Mouth, Clear, with Individual Calibration Certificate, Neck size as per ISO (Long neck)

- Tolerance complies to USP / ASTM E288 standards and dimensions as per ISO 1042 standards
- Supplied with Interchangeable Solid Glass Stopper
- Each flask is marked with individual serial number and supplied with certificate of calibration traceable to National standards
- Amber enamel inscriptions
- Calibrated & certified at 20°C

Product Code	Capacity ml	Tolerance ± ml	Stopper Size	Quantity Per Case	Price / Piece ₹
5645005D	5	0.02	10 / 19#	5	1175.00
5645006D	10	0.02	10 / 19#	5	1020.00
5645008D	20	0.03	10 / 19	5	1025.00
5645009D	25	0.03	10 / 19	5	940.00
5645012D	50	0.05	12 / 21	10	895.00
5645016D	100	0.08	14 / 23	10	880.00
5645020D	200	0.10	14 / 23	10	1230.00
5645021D	250	0.12	14 / 23	10	1235.00
5645024D	500	0.20	19 / 26	10	1625.00
5645029D	1000	0.30	24 / 29	10	2360.00
5645030D	2000	0.50	29 / 32	2	3835.00

- 5 ml to 20 ml supplied with trapezoidal shape for better stability
- # 5 ml & 10 ml stopper size Stopper size as per borosil scientific design

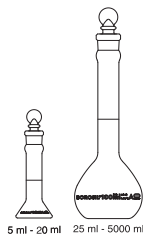

5647 - VOLUMETRIC FLASKS

ASTM, Wide Mouth, Clear, with Individual Calibration Certificate, Neck size as per ASTM (Bulgy neck)

- Complies fully with ASTM E 288 standards - For both dimensions as well as tolerance
- Supplied with Interchangeable Solid Glass Stopper
- Each flask is marked with individual serial number and supplied with certificate of calibration traceable to National standards
- Amber enamel inscriptions
- Specially designed wide mouth for testing bigger diameter tablets without making it in powder form
- Calibrated & certified at 20°C

Product Code	Capacity ml	Tolerance ± ml	Stopper Size	Quantity Per Case	Price / Piece ₹
5647005	5	0.08	13	5	1120.00
5647006	10	0.08	13	5	965.00
5647008	20	0.08	13	5	1000.00
5647009	25	0.08	13	5	1065.00
5647012	50	0.08	13	10	1045.00
5647016	100	0.10	16	10	1095.00
5647020	200	0.20	19	10	1290.00
5647021	250	0.20	19	10	1390.00
5647024	500	0.30	22	10	1730.00
5647029	1000	0.40	27	10	2510.00

- 5 ml to 20 ml supplied with trapezoidal shape for better stability
- For Stopper dimensions refer page no. 146

5647D - VOLUMETRIC FLASKS

Class A, USP, Wide Mouth, Clear, with Individual Calibration Certificate, Neck size as per ISO (Long neck)

- Tolerance complies to ASTM E288 standards and dimensions as per ISO 1042 standards
- Supplied with Interchangeable Solid Glass Stopper
- Each flask is marked with individual serial number and supplied with certificate of calibration traceable to National standards
- Amber enamel inscriptions
- Specially designed wide mouth for testing bigger diameter tablets without making it in powder form
- Calibrated & certified at 20°C

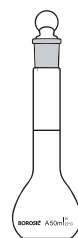

Product Code	Capacity ml	Tolerance ± ml	Stopper Size	Quantity Per Case	Price / Piece ₹
5647005D	5	0.08	12 / 21#	5	1120.00
5647006D	10	0.08	12 / 21#	5	965.00
5647008D	20	0.08	12 / 21	5	1000.00
5647009D	25	0.08	12 / 21	5	1065.00
5647012D	50	0.08	14 / 23	10	1045.00
5647016D	100	0.10	19 / 26	10	1095.00
5647020D	200	0.20	19 / 26	10	1290.00
5647021D	250	0.20	19 / 26	10	1390.00
5647024D	500	0.30	24 / 29	10	1730.00
5647029D	1000	0.40	29 / 32	10	2510.00

- 5 ml to 20 ml supplied with trapezoidal shape for better stability
- # Stopper size as per Borosil Scientific Design



5648 - VOLUMETRIC FLASKS

Class A, Narrow Mouth, Amber, with Individual Calibration Certificate

- Complies with DIN / ISO 1042, Accuracy as per class A
- Supplied with Interchangeable Solid Glass Stopper
- Each flask is marked with individual serial number and supplied with certificate of calibration traceable to National standards
- Amber coating on exterior surfaces to facilitate use with light sensitive solutions
- White enamel inscriptions
- Calibrated & certified at 27°C

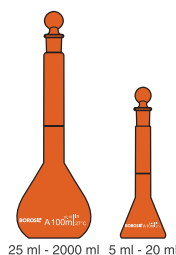

Product Code	Capacity ml	Tolerance ± ml	Stopper Size	Quantity Per Case	Price / Piece ₹
5648005	5	0.025	10 / 19#	5	1250.00
5648006	10	0.025	10 / 19#	5	1085.00
5648008	20	0.04	10 / 19	5	1085.00
5648009	25	0.04	10 / 19	5	1010.00
5648012	50	0.06	12 / 21	10	955.00
5648016	100	0.10	14 / 23	10	940.00
5648020	200	0.15	14 / 23	10	1310.00
5648021	250	0.15	14 / 23	10	1290.00
5648024	500	0.25	19 / 26	10	1725.00
5648029	1000	0.40	24 / 29	10	2515.00
5648030	2000	0.60	29 / 32	2	4085.00

- 5 ml to 20 ml supplied with trapezoidal shape for better stability
- # Stopper size as per Borosil Scientific Design



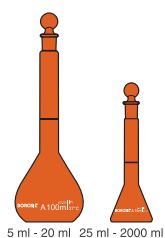

5649 - VOLUMETRIC FLASKS

Class B, Narrow Mouth, Amber

- Complies with DIN /ISO 1042, Accuracy as per class B
- Supplied with interchangeable glass stopper
- Amber coating on exterior surfaces to facilitate use with light sensitive solutions
- White enamel inscriptions
- Calibrated at 27°C

Product Code	Capacity ml	Tolerance ± ml	Stopper Size	Quantity Per Case	Price / Piece ₹
5649005	5	0.05	10 / 19#	10	490.00
5649006	10	0.05	10 / 19#	10	465.00
5649008	20	0.08	10 / 19	10	465.00
5649009	25	0.08	10 / 19	10	465.00
5649012	50	0.12	12 / 21	10	490.00
5649016	100	0.20	14 / 23	10	555.00
5649020	200	0.30	14 / 23	10	585.00
5649021	250	0.30	14 / 23	10	595.00
5649024	500	0.50	19 / 26	10	895.00
5649029	1000	0.80	24 / 29	10	1465.00
5649030	2000	1.20	29 / 32	2	2990.00

- 5 ml to 20 ml supplied with trapezoidal shape for better stability
- Certified and Calibrated at 27°C
- # Stopper size as per Borosil Scientific Design



5650 - VOLUMETRIC FLASKS

For Sugar Estimation, Clear

- Complies with BS 675
- Supplied without stopper
- A two mark flask designed for the analysis of sugar solutions. The two graduation marks provide dilution of 1 in 10

Product Code	Capacity ml	Tolerance ± ml	Quantity Per Case	Price / Piece ₹
5650016	100 / 110	0.15	20	465.00

5653 - VOLUMETRIC FLASKS

Class A, Wide Mouth, Amber, with Individual Calibration Certificate

- Complies with DIN / ISO 1042, Accuracy as per class A
- Supplied with Interchangeable Solid Glass Stopper
- Each flask is marked with individual serial number and supplied with certificate of calibration traceable to National standards
- Amber coating on exterior surfaces to facilitate use with light sensitive solutions
- White enamel inscriptions
- Specially designed wide mouth for testing bigger diameter tablet without making it in powder form
- Calibrated & certified at 27°C



Product Code	Capacity ml	Tolerance ± ml	Stopper Size	Quantity Per Case	Price / Piece ₹
5653005	5	0.04	12 / 21#	5	1230.00
5653006	10	0.04	12 / 21#	5	1075.00
5653008	20	0.06	12 / 21	5	1095.00
5653009	25	0.06	12 / 21	5	1200.00
5653A09	25*	0.06	14 / 23	5	1200.00
5653012	50	0.10	14 / 23	10	1140.00
5653016	100*	0.10	19 / 26	10	1245.00
5653020	200*	0.15	19 / 26	10	1595.00
5653021	250*	0.15	19 / 26	10	2410.00
5653024	500	0.25	24 / 29	10	2475.00
5653029	1000	0.60	29 / 32	10	2590.00

- * Not covered in the standards
- 5 ml to 20 ml supplied with trapezoidal shape for better stability
- # 5 ml & 10 ml (# Stopper size as per borosil scientific design)

5655 - VOLUMETRIC FLASKS

ASTM, Narrow Mouth, Amber, with Individual Calibration Certificate, Neck size as per ASTM (Bulgy neck)

- Complies fully with ASTM E 288 standards - For both dimensions as well as tolerance
- Supplied with Interchangeable Solid Glass Stopper
- Each flask is marked with individual serial number and supplied with certificate of calibration traceable to National standards
- Amber coating on exterior surfaces to facilitate use with light sensitive solutions
- White enamel inscriptions
- Calibrated & certified at 20°C

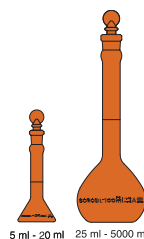

Product Code	Capacity ml	Tolerance ± ml	Stopper Size	Quantity Per Case	Price / Piece ₹
5655005	5	0.02	9	5	1400.00
5655006	10	0.02	9	5	1230.00
5655008	20	0.03	9	5	1230.00
5655009	25	0.03	9	5	1130.00
5655012	50	0.05	9	10	1085.00
5655016	100	0.08	13	10	1060.00
5655020	200	0.10	16	10	1500.00
5655021	250	0.12	16	10	1505.00
5655024	500	0.20	19	10	1980.00
5655029	1000	0.30	22	10	2890.00
5655030	2000	0.50	27	2	4655.00

- 5 ml to 20 ml supplied with trapezoidal shape for better stability
- For Stopper dimensions refer page no. 36

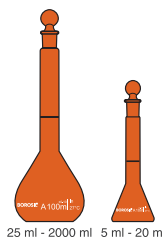

5655D - VOLUMETRIC FLASKS

Class A, USP, Narrow Mouth, Amber, with Individual Calibration Certificate, Neck size as per ISO (Long neck)

- Tolerance complies to ASTM E288 standards and dimensions as per ISO 1042 standards
- Supplied with Interchangeable Solid Glass Stopper
- Each flask is marked with individual serial number and supplied with certificate of calibration traceable to National standards
- Amber coating on exterior surfaces to facilitate use with light sensitive solutions
- White enamel inscriptions
- Calibrated & certified at 20°C

Product Code	Capacity ml	Tolerance ± ml	Stopper Size	Quantity Per Case	Price / Piece ₹
5655005D	5	0.02	10 / 19#	5	1400.00
5655006D	10	0.02	10 / 19#	5	1230.00
5655008D	20	0.03	10 / 19	5	1230.00
5655009D	25	0.03	10 / 19	5	1130.00
5655012D	50	0.05	12 / 21	10	1085.00
5655016D	100	0.08	14 / 23	10	1060.00
5655020D	200	0.10	14 / 23	10	1500.00
5655021D	250	0.12	14 / 23	10	1505.00
5655024D	500	0.20	19 / 26	10	1980.00
5655029D	1000	0.30	24 / 29	10	2890.00
5655030D	2000	0.50	29 / 32	2	4655.00

- 5 ml to 20 ml supplied with trapezoidal shape for better stability
- # 5 ml & 10 ml stopper size not as per standards and kept wide mouth for convenient pipetting

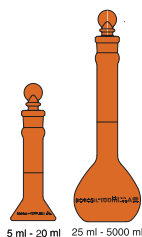

5657 - VOLUMETRIC FLASKS

ASTM, Wide Mouth, Amber, with Individual Calibration Certificate, Neck size as per ASTM (Bulgy neck)

- Complies fully with ASTM E 288 standards - For both dimensions as well as tolerance
- Supplied with Interchangeable Solid Glass Stopper
- Each flask is marked with individual serial number and supplied with certificate of calibration traceable to National standards
- Amber coating on exterior surfaces to facilitate use with light sensitive solutions
- White enamel inscriptions
- Specially designed wide mouth for testing bigger diameter tablets without making it in powder form
- Calibrated & certified at 20°C

Product Code	Capacity ml	Tolerance ± ml	Stopper Size	Quantity Per Case	Price / Piece ₹
5657005	5	0.08	13	5	1360.00
5657006	10	0.08	13	5	1175.00
5657008	20	0.08	13	5	1175.00
5657009	25	0.08	13	5	1275.00
5657012	50	0.08	13	10	1250.00
5657016	100	0.10	16	10	1315.00
5657020	200	0.20	19	10	1550.00
5657021	250	0.20	19	10	1680.00

- 5 ml to 20 ml supplied with trapezoidal shape for better stability
- For Stopper dimensions refer page no. 36

5657D - VOLUMETRIC FLASKS

Class A, USP, Wide Mouth, Amber, with Individual Calibration Certificate, Neck size as per ISO (Long neck)

- Tolerance complies to ASTM E288 standards and dimensions as per ISO 1042 standards
- Supplied with Interchangeable Solid Glass Stopper
- Each flask is marked with individual serial number and supplied with certificate of calibration traceable to National standards
- Amber coating on exterior surfaces to facilitate use with light sensitive solutions
- White enamel inscriptions
- Specially designed wide mouth for testing bigger diameter tablets without making it in powder form
- Calibrated & certified at 20°C

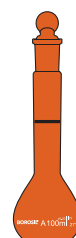

Product Code	Capacity ml	Tolerance ± ml	Stopper Size	Quantity Per Case	Price / Piece ₹
5657005D	5	0.08	12 / 21#	5	1360.00
5657006D	10	0.08	12 / 21#	5	1175.00
5657008D	20	0.08	12 / 21	5	1175.00
5657009D	25	0.08	12 / 21	5	1275.00
5657012D	50	0.08	14 / 23	10	1250.00
5657016D	100	0.10	19 / 26	10	1315.00
5657020D	200	0.20	19 / 26	10	1550.00
5657021D	250	0.20	19 / 26	10	1680.00

- 5 ml to 20 ml supplied with trapezoidal shape for better stability
- # Stopper size as per Borosil Scientific Design

2020 - VOLUMETRIC FLASKS

NABL Certified, Class A, Clear, with Individual Calibration Certificate

- Complies with DIN / ISO 1042, Accuracy as per class A
- Supplied with Interchangeable Glass Stopper
- Each flask is marked with individual serial number and supplied with certificate of calibration traceable to National standards
- Amber enamel inscriptions
- Calibrated & certified at 27°C



Product Code	Capacity ml	Tolerance ± ml	New Stopper Size	New Quantity Per Case	Price / Piece ₹
2020001	1	0.025	7 / 16	1	2610.00
2020002	2	0.025	7 / 16	1	2610.00
2020005	5	0.025	10 / 19 #	1	2320.00
2020006	10	0.025	10 / 19 #	1	2010.00
2020008	20	0.04	10 / 19	1	2010.00
2020009	25	0.04	10 / 19	1	1870.00
2020012	50	0.06	12 / 21	1	1870.00
2020016	100	0.10	14 / 23	1	1925.00
2020020	200	0.15	14 / 23	1	2450.00
2020021	250	0.15	14 / 23	1	2485.00
2020024	500	0.25	19 / 26	1	3310.00
2020029	1000	0.40	24 / 29	1	4755.00
2020030	2000	0.60	29 / 32	1	7695.00

- 1 ml to 20 ml supplied with trapezoidal shape for better stability
- Certified and Calibrated at 27°C
- Volumetric flasks with old stopper sizes - Available till stocks last
- # Stopper size as per Borosil Scientific Design

Volumetric Flasks

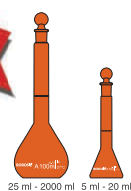

2021 - VOLUMETRIC FLASKS

NABL Certified, Class A, Amber, with Individual Calibration Certificate

- Complies with DIN / ISO 1042, Accuracy as per class A
- Supplied with Interchangeable Glass Stopper
- Each flask is marked with individual serial number and supplied with certificate of calibration traceable to National standards
- White enamel inscriptions
- Calibrated & certified at 27°C

Product Code	Capacity ml	Tolerance ± ml	New Stopper Size	Quantity Per Case	Price / Piece ₹
2021005	5	0.025	10 / 19*	1	2520.00
2021006	10	0.025	10 / 19*	1	2200.00
2021008	20	0.04	10 / 19*	1	2200.00
2021009	25	0.04	10 / 19	1	1990.00
2021012	50	0.06	12 / 21	1	2135.00
2021016	100	0.10	14 / 23	1	2210.00
2021020	200	0.15	14 / 23	1	2630.00
2021021	250	0.15	14 / 23	1	2925.00
2021024	500	0.25	19 / 26	1	3650.00
2021029	1000	0.40	24 / 29	1	5390.00
2021030	2000	0.60	29 / 32	1	8470.00

- 5 ml to 20 ml supplied with trapezoidal shape for better stability
 - # Stopper size as per Borosil Scientific Design



8100 - Glass Stoppers

ISO / DIN, Penny head, Clear

Product Code	Stopper Number	Interchangeable Joint Size	Quantity Per Case	Price / Piece ₹
ISO / DIN Standard (Long Neck)				
8100A10	-	10 / 19	20	115.00
8100A12	-	12 / 21	20	120.00
8100A14	-	14 / 23	20	120.00
8100A19	-	19 / 26	20	140.00
8100A24	-	24 / 29	20	270.00
8100A29	-	29 / 32	20	330.00
8100A34	-	34 / 35	20	345.00

8110 - Glass Stoppers

ASTM, Penny head, Clear



Product Code	Stopper Number	Interchangeable Joint Size	Quantity Per Case	Price / Piece ₹
ASTM Standard (Short Neck)				
8110008	# 8	8.25 / 10	20	115.00
8110009	# 9	9.4 / 14	20	130.00
8110013	# 13	13.4 / 14	20	140.00
8110016	# 16	16.5 / 15	20	270.00
8110019	# 19	19.7 / 17	20	330.00
8110022	# 22	22.05 / 20.5	20	345.00
8110027	# 27	27.15 / 21.5	20	360.00

HSN Code : 70179090

8300 - Polypropylene (PP) Stoppers

- Flat head, ISO standard

Product Code	Interchangeable Joint Size	Quantity Per Case	Price / Piece ₹
8300007	7 / 16	20	55.00
8300A10	10 / 19	20	60.00
8300012	12 / 21	20	65.00
8300A14	14 / 23	20	70.00
8300A19	19 / 26	20	80.00
8300A24	24 / 29	20	100.00
8300A29	29 / 32	20	130.00
8300A34	34 / 35	20	145.00

HSN Code : 39235010

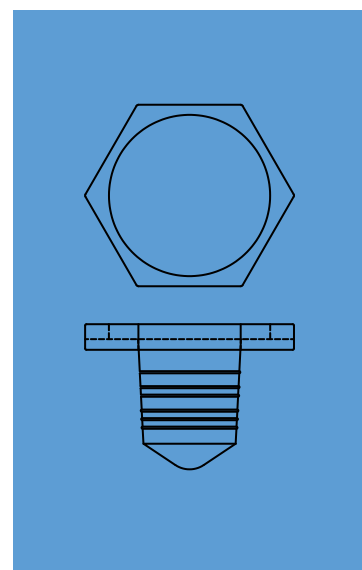

8400 - Glass Stoppers

ISO / DIN, Penny head, Amber

Product Code	Stopper Number	Interchangeable Joint Size	Quantity Per Case	Price / Piece ₹
ISO / DIN Standard (Long Neck)				
8400A10	-	10 / 19	20	140.00
8400A12	-	12 / 21	20	185.00
8400A14	-	14 / 23	20	185.00
8400A19	-	19 / 26	20	210.00
8400A24	-	24 / 29	20	325.00
8400A29	-	29 / 32	20	380.00
8400A34	-	34 / 35	20	415.00

8410 - Glass Stoppers

ASTM, Penny head, Amber

Product Code	Stopper Number	Interchangeable Joint Size	Quantity Per Case	Price / Piece ₹
ASTM Standard				
8410008	# 8	8.25 / 10	20	140.00
8410009	# 9	9.4 / 14	20	150.00
8410013	# 13	13.4 / 14	20	180.00
8410016	# 16	16.5 / 15	20	325.00
8410019	# 19	19.7 / 17	20	400.00
8410022	# 22	22.05 / 20.5	20	420.00
8410027	# 27	27.15 / 21.5	20	435.00



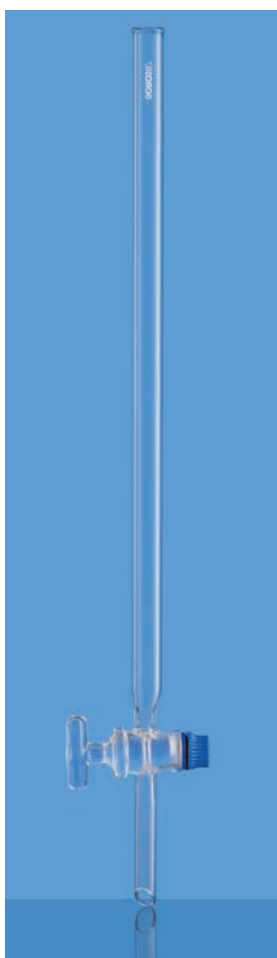

6100 - CHROMATOGRAPHY COLUMNS

Plain With Glass Stopcock



- Designed with straight bore stopcock that increases the life as compared to PTFE key stopcocks
- The glass stopcock enhances control and facilities smoother action
- Generally used for purification of individual compounds from mixtures of compounds

Product Code	Length mm	Bore Dia mm	Quantity Per Case	Price / Piece ₹
6100060	200	10	5	510.00
6100061	300	10	5	550.00
6100062	300	18	5	600.00
6100063	450	30	5	755.00
6100064	500	10	5	595.00
6100065	500	18	5	625.00
6100066	600	30	5	1000.00
6100067	600	40	5	1300.00
6100068	1000	40	4	2660.00

Note : The Columns with Boroflow & PTFE stopcock will be made available on request

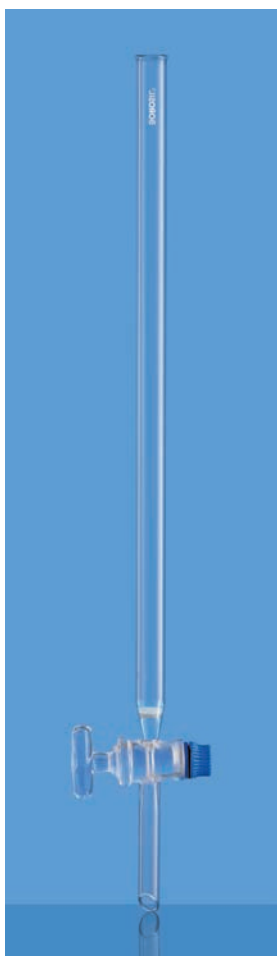

6101 - CHROMATOGRAPHY COLUMNS

With Sintered Disc & Glass Stopcock



- Designed with straight bore stopcock that increases the life as compared to PTFE key stopcocks
- The glass stopcock enhances control and facilities smoother action
- Columns are added with a Sintered Disc for good results
- Generally used for purification of individual compounds from mixtures of compounds
- Columns are added with a Sintered Disc (Grade I) for good result

Product Code	Length mm	Bore Dia mm	Quantity Per Case	Price / Piece ₹
6101060	200	10	5	845.00
6101061	300	10	5	865.00
6101062	300	18	5	1075.00
6101063	450	30	5	1335.00
6101064	500	10	5	1000.00
6101065	500	18	5	1170.00
6101066	600	30	5	1380.00
6101067	600	40	5	2285.00
6101068	1000	40	4	3105.00

Note : The Columns with Boroflow & PTFE stopcock will be made available on request

Accurate and Consistent Filtration, ALWAYS with BOROSIL

Finest Quality Filter Papers

Borosil filter papers are made in collaboration with Hahnemühle - the pioneers in speciality papers since 1883! The papers contain upto 98% alpha cellulose, the most stable form of cellulose in paper pulp, hence making the papers highly stable.

To ensure batch to batch uniformity and consistency in filtering performance, no recycled materials are used in the manufacturing processes. Very low ash content (Avg value 0.004%) aid the laboratory professionals in accurate quantitative analysis with minimal errors.

Made in Germany, the manufacturing processes and product specifications are compliant to the stringent European QC standards, guaranteeing the users finest quality filter papers.



borosilfilters.com



Funnels

Funnels may be used for separating solids from liquids, liquids from liquids and occasionally, for pouring something into a container.

BOROSIL® brand Funnels are available in a comprehensive range for a variety of such applications. Sintered Glass Funnels are also available.

Separating Funnels come in globe, pear and cylindrical shapes with ground glass stopcocks and interchangeable stoppers. These Funnels are made of specially moulded blanks. Stopcock bores, body openings and stems are carefully aligned to facilitate the smooth and even flow of liquid with fast cut-off.



Made from 3.3 Low Expansion Borosilicate Glass



6140 - GLASS FILTER FUNNEL

Short Stem

- Complies with IS 1591, DIN / ISO 4798
- Designed with a 60° bowl angle to ensure precise fitting of the filter paper
- High thermal shock resistance and chemical resistance
- Generally used for filtering and decanting liquids of varied densities

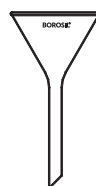

Product Code	Diameter mm	Stem		Quantity Per Case	Price / Piece ₹
		OD	Length		
6140057	25*	6	25	30	115.00
6140058	35	6	35	30	145.00
6140065	50*	8	50	20	150.00
6140069	65*	8	65	20	185.00
6140071	75	8	75	20	175.00
6140077	100	10	100	40	235.00

- * Not covered in standard

6150 - FUNNEL TEST TUBES

- Specially designed for soil testing laboratory

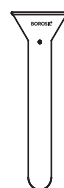

Product Code	Capacity ml	Quantity Per Case	Price / Piece ₹
6150007	15	10	235.00
6150010	30	10	290.00

6220 - POWDER FUNNEL

With Stem

- Designed with a short wide stem to facilitate smooth flow
- Ideal for transferring powders

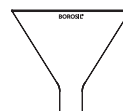

Product Code	Capacity ml	Quantity Per Case	Price / Piece ₹
6220080	125	30	520.00
6220081	150	20	550.00
6220087	200	4	1560.00
6220089	250	4	2140.00

6230 - POWDER FUNNEL

Stem With Cone

- Supplied with ground glass cone for easy fitting on flask
- Interchangeable joint size 24/29
- Designed with a short wide stem to facilitate smooth flow
- Ideal for transferring powders

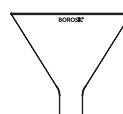

Product Code	Capacity ml	Quantity Per Case	Price / Piece ₹
6230080	125	20	775.00
6230081	150	20	895.00
6230087	200	4	1725.00
6230089	250	4	2595.00

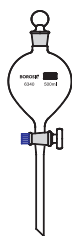

6340 - SEPARATING FUNNEL, GLOBE SHAPE With Glass Stopcock & 1/2 Glass Stopper

- Designed with globe shape and with a stem
- Generally used in the separation phase

Product Code	Capacity ml	Stopper Size	Quantity Per Case	Price / Piece ₹
6340017	125	19 / 26	10	1490.00
6340021	250	24 / 29	10	1635.00
6340024	500	24 / 29	10	2055.00
6340029	1000	29 / 32	5	2595.00
6340030	2000	29 / 32	10	4380.00
6340033	5000	34 / 35	1	9935.00



6400 - SEPARATING FUNNEL, PEAR SHAPE With Glass Stopcock & 1/2 Glass Stopper

- Complies with IS 1575, DIN / ISO 4800
- Designed with pear shape and with a stem
- Generally used in the separation phase

Product Code	Capacity ml	Stopper Size	Quantity Per Case	Price / Piece ₹
6400013	60*	14 / 23	10	1270.00
6400017	125*	19 / 26	10	1380.00
6400021	250	24 / 29	10	1455.00
6400024	500	24 / 29	10	2010.00
6400029	1000	29 / 32	10	2630.00
6400030	2000	29 / 32	10	4785.00

* Not covered in standards.



6402 - SEPARATING FUNNEL, PEAR SHAPE With Boroflo Stopcock And 1/2 Glass Stopper

- Complies with IS 1575, DIN / ISO 4800
- Designed with pear shape and with a stem
- Generally used in the separation phase

Product Code	Capacity ml	Stopper Size	Quantity Per Case	Price / Piece ₹
6402013	60*	14 / 23	10	1135.00
6402017	125*	19 / 26	10	1230.00
6402021	250	24 / 29	10	1360.00
6402024	500	24 / 29	10	1830.00
6402029	1000	29 / 32	10	2405.00
6402030	2000	29 / 32	10	4225.00

* Not covered in standards.

6403 - SEPARATING FUNNEL, PEAR SHAPE, With PTFE Stopcock And I/C Glass Stopper

- Complies with IS 1575, DIN / ISO 4800
- Designed with pear shape and with a stem
- Generally used in the separation phase



Product Code	Capacity ml	Stopper Size	Quantity Per Case	Price / Piece ₹
6403017	125*	19 / 26	10	1605.00
6403021	250	24 / 29	10	1755.00
6403024	500	24 / 29	10	2285.00
6403029	1000	29 / 32	10	2725.00
6403030	2000	29 / 32	10	5065.00

* Not covered in standards.



6405 - PRESSURE EQUILISING CYLINDRICAL FUNNEL

With PTFE Stopcock

- Supplied with polypropylene stopper
- Equipped with totally grease free and self lubricating PTFE stopcock



Product Code	Capacity ml	Socket	Cone	Quantity Per Case	Price / Piece ₹
6405012	50	19 / 26	19 / 26	5	1535.00
6405016	100	19 / 26	19 / 26	5	1845.00
6405021	250	24 / 29	24 / 29	5	2105.00
6405024	500	24 / 29	24 / 29	5	3265.00



6408 - DROPPING FUNNEL, Graduated With Glass Stopcock

- Complies with IS 1575, DIN / ISO 4800
- Supplied with glass stopcock

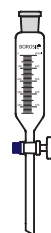

Product Code	Capacity ml	Stopper Size	Quantity Per Case	Price / Piece ₹
6408012	50	14 / 23	5	970.00
6408016	100	19 / 26	5	1055.00
6408021	250	24 / 29	5	1220.00
6408024	500	24 / 29	5	1635.00
6408029	1000	29 / 32	5	2710.00

* Not covered in standards.



Funnels



6560 - PLAIN SHANK SINGLE CONE

- Complies to DIN 12249
- Joints are made with precision grinding

Product Code	Cone Joint Size	Total Length	Quantity Per Case	Price / Piece ₹
6560010	10 / 19	120	5	185.00
6560012	12 / 21	120	5	195.00
6560014	14 / 23	120	5	215.00
6560019	19 / 26	125	5	255.00
6560024	24 / 29	135	5	310.00
6560029	29 / 32	135	5	395.00
6560034	34 / 35	150	5	550.00
6560040	40 / 38*	150	5	630.00
6560045	45 / 40*	150	5	750.00
6560050	50 / 42*	150	5	865.00
6560055	55 / 44	150	5	1025.00

* Not covered in standard



6561- PLAIN SHANK DOUBLE CONE

- Complies to DIN 12249
- Joints are made with precision grinding

Product Code	Cone Joint Size	Total Length	Quantity Per Case	Price / Piece ₹
6561010	10 / 19	125	5	345.00
6561012	12 / 21	135	5	400.00
6561014	14 / 23	135	5	490.00
6561019	19 / 26	140	5	550.00
6561024	24 / 29	170	5	660.00
6561029	29 / 32	170	5	910.00
6561034	34 / 35	180	5	1065.00
6561040	40 / 38	185	5	1270.00

6580 - PLAIN SHANK SINGLE SOCKET

- Complies to DIN 12249
- Joints are made with precision grinding



Product Code	Cone Joint Size	Total Length	Quantity Per Case	Price / Piece ₹
6580010	10 / 19	120	5	195.00
6580012	12 / 21	120	5	225.00
6580014	14 / 23	120	5	250.00
6580019	19 / 26	125	5	255.00
6580024	24 / 29	135	5	320.00
6580029	29 / 32	135	5	395.00
6580034	34 / 35	150	5	550.00
6580040	40 / 38	150	5	670.00
6580045	45 / 40	150	5	865.00
6580050	50 / 42	150	5	985.00
6580055	55 / 44	150	5	1225.00



6581 - PLAIN SHANK DOUBLE SOCKET

- Complies to DIN 12249
- Joints are made with precision grinding



Product Code	Cone Joint Size	Total Length	Quantity Per Case	Price / Piece ₹
6581010	10 / 19	125	5	320.00
6581012	12 / 21	135	5	380.00
6581014	14 / 23	135	5	440.00
6581019	19 / 26	140	5	490.00
6581024	24 / 29	170	5	550.00
6581029	29 / 32	170	5	660.00
6581034	34 / 35	180	5	910.00
6581040	40 / 38	185	5	985.00



Socket

Gas Generator

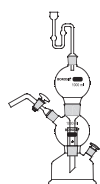

6550 - GAS GENERATOR APPARATUS (KIPPS)

- Used to produce common gases
- Simple to operate and assemble
- Quick charging

Product Code	Capacity ml	Quantity Per Case	Price / Piece ₹
6550024	500	1	12225.00
6550029	1000	1	15620.00

Museum Jar

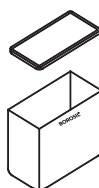

6910 - RECTANGULAR MUSEUM JAR With Lid

- Jar made of 3.3 low expansion borosilicate glass and lid made from sodalime glass
- Specially blown to give sturdiness and long life
- Top edges are flat ground
- Not recommended for use over a direct flame or on a hot plate
- For storage and display of preserved organs and organisms in Museums, Hospitals and Medical Colleges

Product Code	Approx Height x Length x Breadth mm	Quantity Per Case	Price / Piece ₹
6910M41	200 x 125 x 125	1	10695.00
6910M42	200 x 150 x 100	1	11325.00
6910M43	220 x 195 x 80	1	12600.00
6910M44	250 x 165 x 140	1	13190.00
6910M45	250 x 250 x 120	1	15870.00
6910M46	360 x 150 x 100	1	26595.00

6912 - CYLINDRICAL MUSEUM JAR **NEW** With Lid

- Jar made of 3.3 low expansion borosilicate glass and lid made from sodalime glass
- Specially blown to give sturdiness and long life
- Not recommended for use over a direct flame or on a hot plate
- For storage and display of preserved organs and organisms in Museums, Hospitals and Medical Colleges

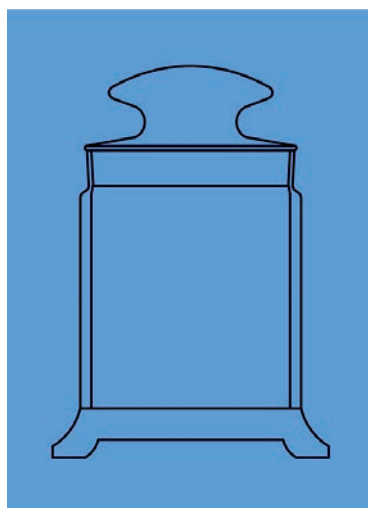

Product Code	Approx Height x Length (mm)	Quantity Per Case	Price / Piece ₹
6912M61	100 x 150	2	5290.00
6912M62	115 x 200	2	6715.00
6912M63	130 x 300	2	9110.00
6912M64	150 x 300	2	12095.00
6912M65	230 x 300	2	21480.00

6947 - REACTION KETTLES ASSEMBLY

Resin Reaction

- The wide mouth enables easy access for cleaning the interior
- Flanges of the covers and base are finely ground to ensure a tight seal
- Equipped with interchangeable covers with four openings
- Designed for viscous reaction materials



Product Code	Capacity ml	Body Dia mm	Height mm	Quantity Per Case Set	Price / Piece ₹
6947024	500	100	150	1	15730.00
6947029	1000	110	175	1	16400.00
6947030	2000	150	185	1	19990.00
6947032	4000	150	340	1	24035.00

The 500 ml and 1000 ml kettles have interchangeable covers with four openings to accommodate 24 / 29 interchangeable joints. Kettles of 2000 ml and 4000 ml capacity have interchangeable covers with openings to accommodate three 24 / 29 interchangeable joints and one 34 / 35 interchangeable joint.

6948 - BOTTOM FOR KETTLE REACTION ASSEMBLY

Only for Kettles Cat no. 6947

The base has a wide mouth that enables easy access for cleaning the interior
Flanges of the base are finely ground to ensure a tight seal



Product Code	Capacity ml	Quantity Per Case	Price / Piece ₹
6948024	500	2	7595.00
6948029	1000	2	8440.00
6948030	2000	2	10955.00
6948032	4000	2	16015.00

6949 - COVER FOR KETTLE REACTION ASSEMBLY

Only for Kettles Cat No. 6947

- The covers have openings with interchangeable joints to facilitate rapid assembly with Condensers and Stirrers
- Flanges of the covers are finely ground to ensure a tight seal

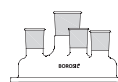

Product Code	Capacity ml	Quantity Per Case	Price / Piece ₹
6949041	500 / 1000	2	12090.00
6949042	2000 / 4000	2	14040.00

The 500 ml and 1000 ml kettles have interchangeable covers with four openings to accommodate 24 / 29 interchangeable joints. Kettles of 2000 ml and 4000 ml capacity have interchangeable covers with openings to accommodate three 24 / 29 interchangeable joints and one 34 / 35 interchangeable joint.

Pipettes

BOROSIL® Pipettes are made from heavy walled, machine drawn borosilicate glass tubing, of precise bore sizes, to provide highest level of accuracy. The mouthpiece of pipettes, of capacities >5ml are tooled with uniform OD for easy aspiration of liquids. Tooling imparts additional strength to the pipettes.

- Individually calibrated by automatic calibration process
- Available in both Class A and Class B tolerances
- Individual calibration certificate provided for Class A pipettes
- Graduation markings made using finest quality white enamel or amber ink to ensure maximum durability
- Color coded in accordance with ISO standards to facilitate easy identification
- Chip resistant bevelled ground edges
- Pipettes can be autoclaved or flame sterilized as per requirement

**Made from 3.3 Low Expansion
Borosilicate Glass**

USP
TYPE I

TYPE I
ASTM
E438
CLASS A

ISO
3585



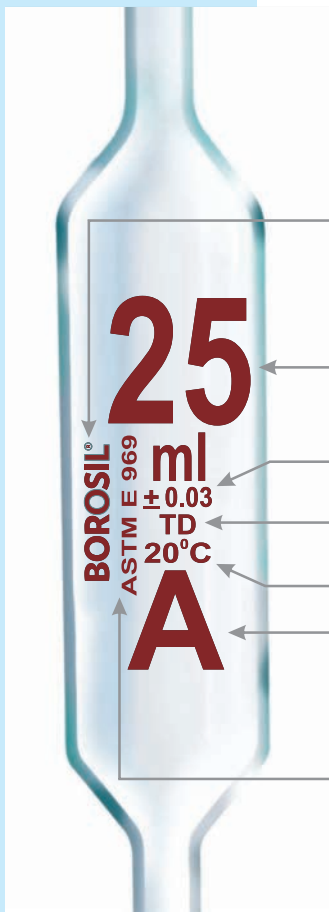

Manufacturer

Nominal Capacity

Tolerance

Calibration (TD= to deliver)

Ref Temperature

Class A Certified (Quality Grade)

Standards

25
ml
±0.03
TD
20°C
A

BOROSIL®
ASTM E 969



Mohr Type
Delivery from zero mark to the last graduation mark



Serological Type
Delivery from zero mark to the tip
Two Rings
Two rings at the top indicate that pipettes are calibrated to deliver their total capacity



Tips are carefully tooled to ensure proper flow rates
Tip edges are fire polished



All pipettes are colour coded for quick identification

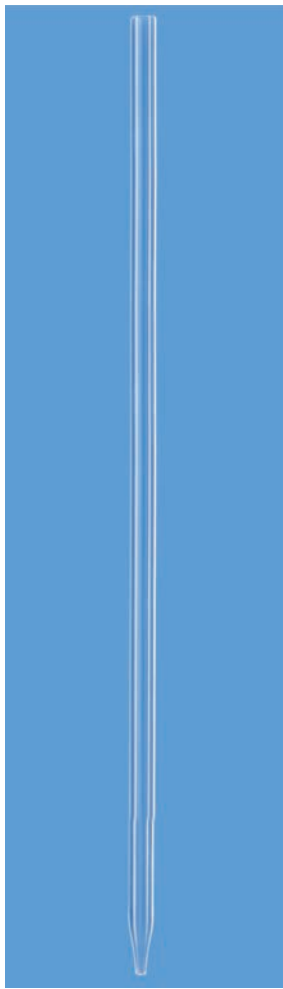

7040 - ARTIFICIAL INSEMINATION PIPETTES

- Sturdy, strong and safe for repeated use
- It can be sterilised and cleaned easily
- Tapered tip for efficient use
- Ideal for artificial insemination in cattles

Product Code	Length mm	Quantity Per Case	Price / Piece ₹
7040162	450	60	130.00

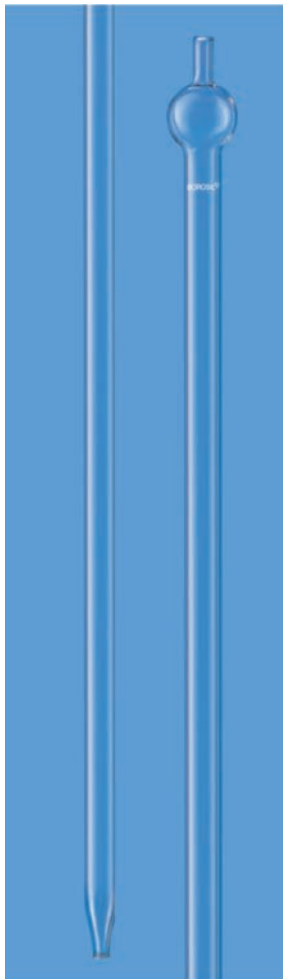

7041 - DRUM SAMPLING PIPETTE

Product Code	Length mm	Quantity Per Case	Price / Piece ₹
7041041	1000	4	570.00

7056 - MILK/BACTERIOLOGICAL PIPETTES

- Complies with IS 2025
- Available in two capacities - 1.1ml and 2.2 ml
- 1.1 ml is graduated at 0.5 to 1.1 ml
- 2.2 ml is graduated at 1.0, 2.0, 2.1 and 2.2 ml
- Used for the bacteriological examination of milk in dairy industries



Product Code	Capacity ml	Tolerance \pm ml	Quantity Per Case	Price / Piece ₹
7056101	1.1	0.025	10	235.00
7056102	2.2	0.040	10	260.00

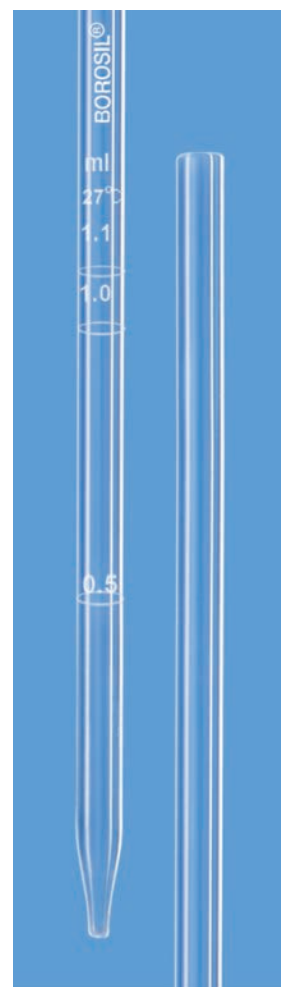

7057 - GERBER MILK PIPETTES

- Complies with IS 1223 (Part II)
- Sturdy, designed to last long
- Used for testing milk by the Gerber method
- Gerber Milk Pipettes are one-mark transfer Pipettes for measuring 10.75 ml
- They can be also be used in rural Milk Collection Centres



Product Code	Capacity ml	Tolerance \pm ml	Quantity Per Case	Price / Piece ₹
7057P10	10.75	0.03	10	250.00



Pipettes

7058 - GERBER MILK PIPETTES with Certificate

- Provided with calibration certificate

Product Code	Capacity ml	Tolerance \pm ml	Quantity Per Case	Price / Piece ₹
7058P10	10.75	0.015	10	520.00

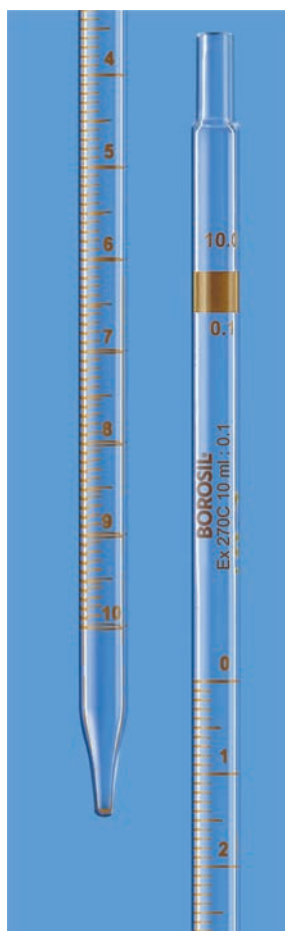

7059 - MOHR PIPETTES

Class A, with Individual Calibration Certificate

- Complies with IS, ISO 835, Type I
- Graduated for delivery from zero mark to the last graduation mark
- Supplied with individual calibration certificate showing actual volume dispensed and providing traceability to national standards
- Markings are made in permanent amber stain diffused into the surface of the glass for better visibility and durability
- Calibrated and certified at 27°C

Product Code	Capacity ml	Graduation Interval ml	Tolerance +/- ml	Quantity per Case	Price / Piece ₹
7059P41	0.1	0.01	0.006	10	650.00
7059P42	0.2	0.01	0.006	10	650.00
7059P01	1	0.01	0.007	10	610.00
7059P11	1	0.10	0.007	10	540.00
7059P02	2	0.02	0.01	10	600.00
7059P22	2	0.10	0.01	10	560.00
7059P05	5	0.05	0.03	10	695.00
7059P55	5	0.10	0.03	10	650.00
7059P06	10	0.10	0.05	10	745.00
7059P09	25	0.20	0.10	10	880.00



7060 - MOHR PIPETTES

Class B

- Complies with IS, ISO 835, Type I
- Graduated for delivery from zero mark to the last graduation mark
- Markings are made in permanent amber stain diffused into the surface of the glass for better visibility and durability
- Calibrated at 27°C

Product Code	Capacity ml	Graduation Interval ml	Tolerance +/- ml	Quantity Per Case	Price / Piece ₹
7060P41	0.1	0.01	0.01	20	215.00
7060P42	0.2	0.01	0.01	20	205.00
7060P01	1	0.01	0.01	20	205.00
7060P11	1	0.10	0.01	20	190.00
7060P02	2	0.02	0.02	20	215.00
7060P22	2	0.10	0.02	20	205.00
7060P05	5	0.05	0.05	20	230.00
7060P55	5	0.10	0.05	20	215.00
7060P06	10	0.10	0.10	20	250.00
7060P09	25	0.20	0.20	20	390.00

7062 - MOHR PIPETTES

Class B, White Marking

- Complies with ISO 835
- Graduated for delivery from zero mark to the last graduation mark
- Graduation in white enamel for increased visibility against dark solutions
- Calibrated at 27°C



Product Code	Capacity ml	Graduation Interval ml	Tolerance \pm ml	Quantity Per Case	Price / Piece ₹
7062P41	0.1	0.01	0.01	20	215.00
7062P42	0.2	0.01	0.01	20	205.00
7062P01	1	0.01	0.01	20	205.00
7062P11	1	0.10	0.01	20	190.00
7062P02	2	0.02	0.02	20	215.00
7062P22	2	0.10	0.02	20	205.00
7062P05	5	0.05	0.05	20	230.00
7062P55	5	0.10	0.05	20	215.00
7062P06	10	0.10	0.10	20	250.00
7062P09	25	0.20	0.20	20	390.00

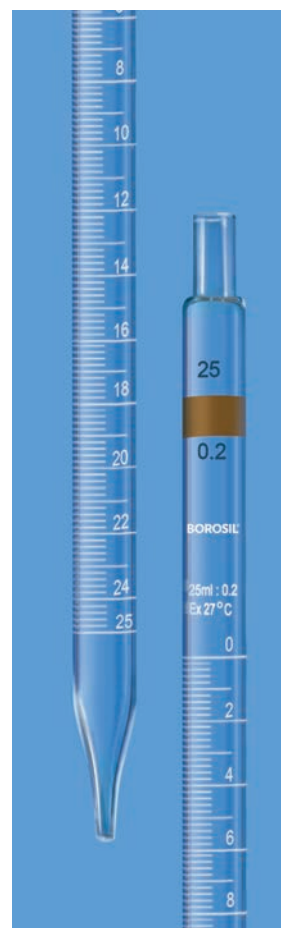

7079 - SEROLOGICAL PIPETTES

Class A, With Individual Calibration Certificate

- Complies with IS, ISO 835, Type III total delivery
- These Pipettes are graduated to the tip
- Two rings at the top indicate that the Pipette is calibrated to deliver from any graduation line down to tip
- Supplied with individual calibration certificate showing actual volume dispensed and providing traceability to national standards
- Markings are made in permanent amber stain diffused into the surface of the glass for better visibility and durability
- Calibrated and certified at 27°C



Product Code	Capacity ml	Graduation Interval ml	Tolerance \pm ml	Quantity Per Case	Price / Piece ₹
7079P41	0.1	0.01	0.006	10	650.00
7079P42	0.2	0.01	0.006	10	650.00
7079P01	1	0.01	0.007	10	610.00
7079P11	1	0.10	0.007	10	540.00
7079P02	2	0.02	0.01	10	600.00
7079P22	2	0.10	0.01	10	560.00
7079P05	5	0.05	0.03	10	695.00
7079P55	5	0.10	0.03	10	650.00
7079P06	10	0.10	0.05	10	745.00
7079P09	25	0.20	0.10	10	880.00

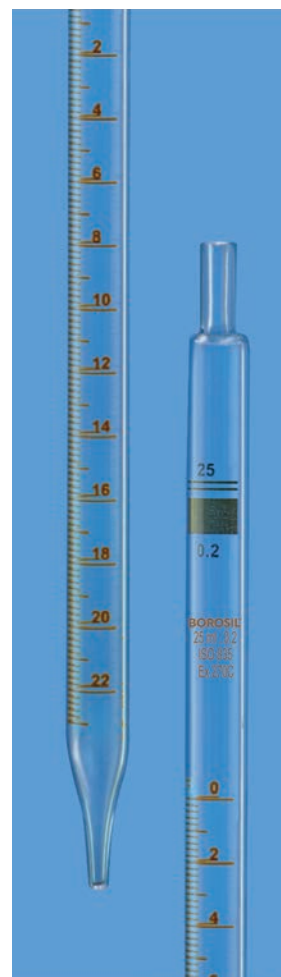

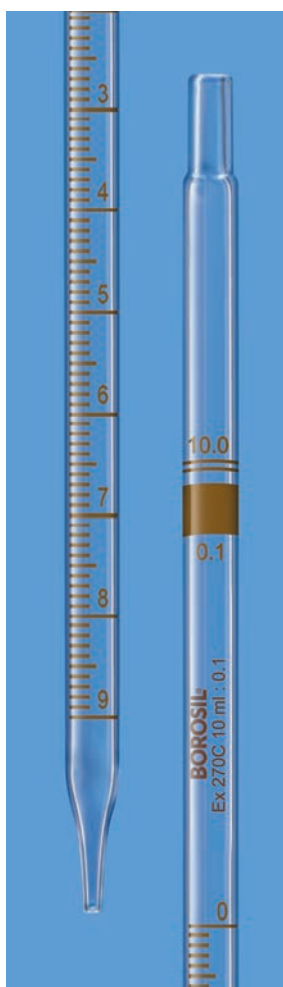

7080 - SEROLOGICAL PIPETTES

Class B

- Complies with IS, ISO 835
- These Pipettes are graduated to the tip
- Two rings at the top indicate that the Pipette is calibrated to deliver from any graduation line down to tip
- Markings are made in permanent amber stain diffused into the surface of the glass for better visibility and durability
- Calibrated at 27°C

Product Code	Capacity ml	Graduation Interval ml	Tolerance \pm ml	Quantity Per Case	Price / Piece ₹
7080P41	0.1	0.01	0.01	20	215.00
7080P42	0.2	0.01	0.01	20	205.00
7080P01	1	0.01	0.01	20	205.00
7080P11	1	0.10	0.01	20	190.00
7080P02	2	0.02	0.02	20	215.00
7080P22	2	0.10	0.02	20	205.00
7080P05	5	0.05	0.05	20	230.00
7080P55	5	0.10	0.05	20	215.00
7080P06	10	0.10	0.10	20	250.00
7080P09	25	0.20	0.20	20	390.00

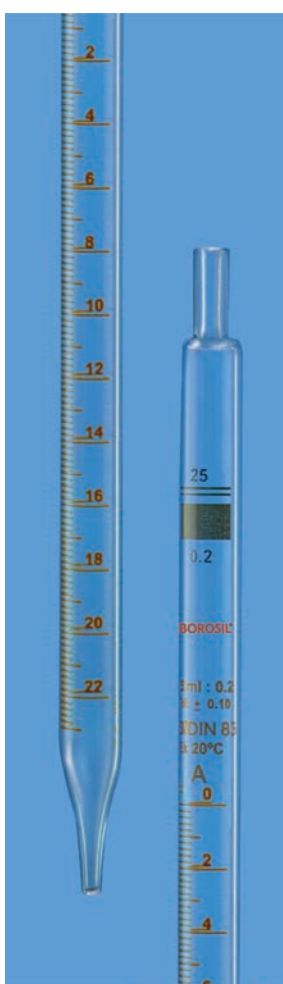

7081 - SEROLOGICAL PIPETTES

Class A, USP, With Individual Calibration Certificate

- Complies with ASTM 1293 - 02
- These pipettes are graduated to the tip
- Two rings at the top indicate that the pipette is calibrated to deliver from any graduation line down to tip
- Supplied with individual calibration certificate showing actual volume dispensed and providing traceability to national standards
- Markings are made in permanent amber stain diffused into the surface of the glass for better visibility and durability
- Calibrated and certified at 20°C

Product Code	Capacity ml	Graduation Interval ml	Tolerance \pm ml	Quantity Per Case	Price / Piece ₹
7081P01	1	0.01	0.01	10	585.00
7081P11	1	0.10	0.01	10	550.00
7081P22	2	0.10	0.01	10	585.00
7081P55	5	0.10	0.02	10	700.00
7081P06	10	0.10	0.03	10	760.00
7081P09	25	0.10	0.05	10	895.00

7082 - SEROLOGICAL PIPETTES

Class B, White marking

- Complies with IS, ISO 835
- These Pipettes are graduated to the tip
- Two rings at the top indicate that the Pipette is calibrated to deliver from any graduation line down to tip
- Graduation in white enamel for increased visibility against dark solutions
- Calibrated at 27°C



Product Code	Capacity ml	Graduation Interval ml	Tolerance \pm ml	Quantity Per Case	Price / Piece ₹
7082P41	0.1	0.01	0.01	20	215.00
7082P42	0.2	0.01	0.01	20	205.00
7082P01	1	0.01	0.01	20	205.00
7082P11	1	0.10	0.01	20	190.00
7082P02	2	0.02	0.02	20	215.00
7082P22	2	0.10	0.02	20	205.00
7082P05	5	0.05	0.05	20	230.00
7082P55	5	0.10	0.05	20	215.00
7082P06	10	0.10	0.10	20	250.00
7082P09	25	0.20	0.20	20	390.00

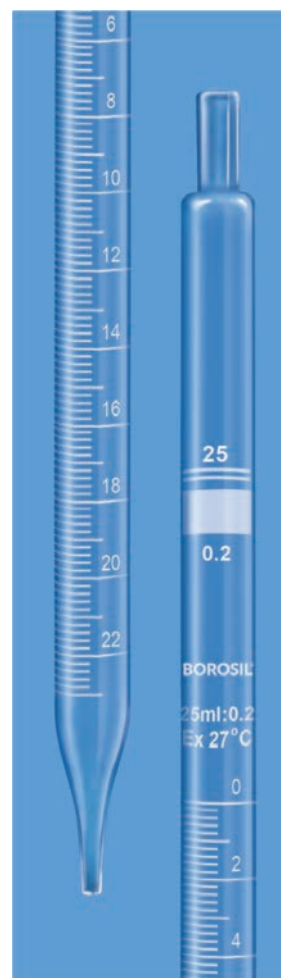

7100 - VOLUMETRIC PIPETTES

Class A, with Individual Calibration Certificate

- Complies with ISO 648
- Calibrated for delivery (TD, Ex)
- Each pipette coded with unique identification number (UID) and supplied with calibration certificate with traceability to national standards
- Generally used for accurate measurement and decanting of liquid
- Calibrated and certified at 27°C



Product Code	Capacity ml	Tolerance \pm ml	Quantity Per Case	Price / Piece ₹
7100001	1	0.008	10	410.00
7100002	2	0.01	10	415.00
7100005	5	0.015	10	465.00
7100006	10	0.02	10	560.00
7100008	20	0.03	10	730.00
7100009	25	0.03	10	775.00
7100012	50	0.05	10	880.00
7100016	100	0.08	10	1330.00





7101 - VOLUMETRIC PIPETTES

Class A, ASTM with Individual Calibration Certificate

- Complies with ASTM E-969-02
- Calibrated for delivery (TD, Ex)
- Each pipette coded with unique identification number (UID) and supplied with calibration certificate with traceability to national standards
- Generally used for accurate measurement and decanting of liquid
- Calibrated and certified at 20°C

Product Code	Capacity ml	Tolerance ± ml	Quantity Per Case	Price / Piece ₹
7101001	1	0.006	10	430.00
7101105	1.5*	0.006	10	480.00
7101002	2	0.006	10	480.00
7101205	2.5*	0.006	10	540.00
7101003	3	0.01	10	505.00
7101004	4	0.01	10	505.00
7101005	5	0.01	10	510.00
7101706	6	0.01	10	560.00
7101707	7	0.01	10	560.00
7101708	8	0.02	10	560.00
7101709	9	0.02	10	560.00
7101006	10	0.02	10	580.00
7101007	15	0.03	10	655.00
7101008	20	0.03	10	760.00
7101009	25	0.03	10	800.00
7101010	30	0.03	10	800.00
7101011	40	0.05	10	850.00
7101012	50	0.05	10	925.00
7101016	100	0.08	10	1390.00

* As per Borosil Scientific standard



7102 - VOLUMETRIC PIPETTES

Class B

- Complies with ISO 648
- Calibrated for delivery (TD, Ex)
- Generally used for accurate measurement and decanting of liquid
- Calibrated at 27°C

Product Code	Capacity ml	Tolerance ± ml	Quantity Per Case	Price / Piece ₹
7102001	1	0.015	10	205.00
7102002	2	0.02	10	215.00
7102003	3*	0.02	10	215.00
7102004	4*	0.02	10	215.00
7102005	5	0.03	10	230.00
7102706	6*	0.03	10	245.00
7102707	7*	0.03	10	245.00
7102708	8*	0.04	10	245.00
7102709	9*	0.04	10	245.00
7102006	10	0.04	10	265.00
7102007	15*	0.06	10	300.00
7102008	20	0.06	10	305.00
7102009	25	0.06	10	320.00
7102010	30*	0.06	10	310.00
7102011	40*	0.1	10	340.00
7102012	50	0.1	10	375.00
7102016	100	0.15	10	535.00

* As per Borosil Scientific standard

7103 - VOLUMETRIC PIPETTES

Class B, ASTM

- Complies with ASTM E-969-02
- Calibrated for delivery (TD, Ex)
- Generally used for accurate measurement and decanting of liquid
- Calibrated at 20°C



Till stock lasts				
Product Code	Capacity ml	Tolerance ± ml	Quantity Per Case	Price / Piece ₹
7103001	1	0.012	10	210.00
7103002	2	0.012	10	220.00
7103003	3	0.02	10	210.00
7103004	4	0.02	10	220.00
7103005	5	0.02	10	220.00
7103706	6	0.03	10	235.00
7103707	7	0.03	10	225.00
7103708	8	0.04	10	235.00
7103709	9	0.04	10	225.00
7103006	10	0.04	10	255.00
7103007	15	0.06	10	285.00
7103008	20	0.06	10	295.00
7103009	25	0.06	10	310.00
7103010	30*	0.06	10	310.00
7103011	40*	0.10	10	325.00
7103012	50	0.10	10	365.00
7103016	100	0.16	10	515.00

* As per Borosil Scientific standard

7106 - VOLUMETRIC PIPETTES

Class A, ASTM, Amber, with Individual Calibration Certificate

- Complies with ASTM E-969-02
- Calibrated for delivery (TD, Ex)
- Each pipette coded with unique identification number (UID) and supplied with calibration certificate with traceability to national standards
- Uniform amber colour protects liquids from light radiation with a wave-length between 300 nm and 500 nm
- Ideal for use with light-sensitive solutions
- Generally used for accurate measurement and decanting of liquid
- Calibrated and certified at 20°C



Product Code	Capacity ml	Tolerance ± ml	Quantity Per Case	Price / Piece ₹
7106001	1	0.006	10	730.00
7106002	2	0.006	10	730.00
7106005	5	0.01	10	800.00
7106006	10	0.02	10	830.00
7106008	20	0.03	10	895.00
7106009	25	0.03	10	895.00
7106012	50	0.05	10	1050.00
7106016	100	0.08	10	1390.00

NABL
CERTIFIED



2030 - MOHR PIPETTES

NABL Certified, Class A

- Complies with IS, ISO 835, Type I
- Graduated for delivery from zero mark to the last graduation mark
- Supplied with individual NABL calibration certificate showing actual volume dispensed and providing traceability to national standards
- Markings are made in permanent amber stain diffused into the surface of the glass for better visibility and durability
- Calibrated & certified at 27°C

Product Code	Capacity ml	Graduation Interval ml	Tolerance \pm ml	Quantity Per Case	Price / Piece ₹
2030P41	0.1	0.01	0.006	1	1295.00
2030P42	0.2	0.01	0.006	1	1295.00
2030P01	1	0.01	0.007	1	1260.00
2030P11	1	0.10	0.007	1	1400.00
2030P02	2	0.02	0.01	1	1320.00
2030P22	2	0.10	0.01	1	1260.00
2030P05	5	0.05	0.03	1	1405.00
2030P55	5	0.10	0.03	1	1295.00
2030P06	10	0.10	0.05	1	1555.00
2030P09	25	0.20	0.10	1	1965.00

NABL
CERTIFIED



2040 - VOLUMETRIC PIPETTES

NABL Certified, Class A, with Individual Calibration Certificate

- Complies with IS 1117, ISO 648
- Calibrated for delivery (TD, Ex)
- Each pipette coded with unique identification number (UID) and supplied with NABL calibration certificate with traceability to national standards
- Generally used for accurate measurement and decanting of liquid
- Calibrated and certified at 27°C

Product Code	Capacity ml	Tolerance \pm ml	Quantity Per Case	Price / Piece ₹
2040001	1	0.008	1	1095.00
2040002	2	0.01	1	1170.00
2040005	5	0.015	1	1255.00
2040006	10	0.02	1	1325.00
2040008	20	0.03	1	1505.00
2040009	25	0.03	1	1615.00
2040012	50	0.05	1	2070.00
2040016	100	0.08	1	2735.00

NABL Certified Glassware

For critical laboratory applications

- Volumetric Flasks
- Measuring Cylinders
- Volumetric and Graduated Pipettes
- Burettes
- Relative Density Bottles



Weighing Scoop

Borosil Weighing Scoops are primarily used when small quantities of powder, liquid or semi-solid material need to be weighed. The powder can be introduced into the receiving vessel through the tubular stem.



7200 - GLASS WEIGHING SCOOP

- Weighing scoops have an open tubular arm.
- Ideal for weighing small quantities of dyes and powders

Product Code	Capacity ml	Quantity Per Case	Price / Piece ₹
7200P45	0.5	10	305.00
7200001	1	10	270.00
7200002	2	10	270.00
7200003	3	10	220.00
7200076	6	10	290.00
7200006	10	10	330.00

Mortar and Pestle

Made of borosilicate glass for fine grinding of high purity substances

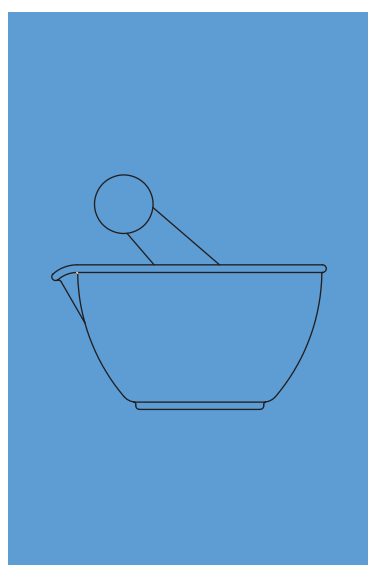

7210 - GLASS MORTAR AND PESTLE

Inside Rough

- Inside surface is made rough to ensure fine grinding
- Designed with pour out for which allows easy decanting of liquids

Product Code	Top Diameter mm	Height* mm	Quantity Per Case	Price / Piece ₹
7210040	80	60	2	6610.00
7210041	100	75	2	8035.00
7210042	150	110	2	13090.00

* Height indicated is of mortar only

Based on your needs, we offer an assortment of centrifuge tubes, Folin-Wu Tubes. All are made from uniformly drawn high quality tubing for extended service life and your safety.

Tubes

7840 - FOLIN - WU BLOOD SUGAR TUBE

- Complies with IS 3740
- Made of uniformly drawn high quality tubing for extended service life
- The tube is calibrated at 12.5 ml and 25 ml



Product Code	Capacity ml	Approx O.D. x Length mm	Quantity Per Case	Price / Piece ₹
7840009	25	20 x 220	20	328.00



8060 - CENTRIFUGE TUBE

Plain

- Made of uniformly drawn high quality tubing for extended service life
- Designed with conical bottom for the higher density fraction collection at the bottom of the tube
- Consequently, even small amounts of solids can be collected and separated



Product Code	Capacity ml	Approx O.D. x Length mm	Quantity Per Case	Price / Piece ₹
8060007	15	17 x 120	100	88.00



8080 - CENTRIFUGE TUBE

Graduated

- Made of uniformly drawn high quality tubing for extended service life
- Designed with conical bottom for the higher density fraction collection at the bottom of the tube
- Consequently, even small amounts of solids can be collected and separated
- Graduated for greater precision



Product Code	Capacity ml	Approx O.D. x Length	Quantity Per Case	Price / Piece ₹
8080007	15	17 x 120	30	177.00
8080012	50	29 x 135	20	348.00

Amber colour Centrifuge tube available Product Code: 8081





8084 - CENTRIFUGE TUBE

Graduated With I/C Glass Stopper

- Made of uniformly drawn high quality tubing for extended service life
- Designed with conical bottom for the higher density fraction collection at the bottom of the tube
- Consequently, even small amounts of solids can be collected and separated
- Graduated for greater precision
- Supplied with glass stopper

Product Code	Capacity ml	Approx O.D. x Length mm	Quantity Per Case	Price / Piece ₹
8084007	15	17 x 145	30	530.00
8084012	50	29 x 165	10	666.00

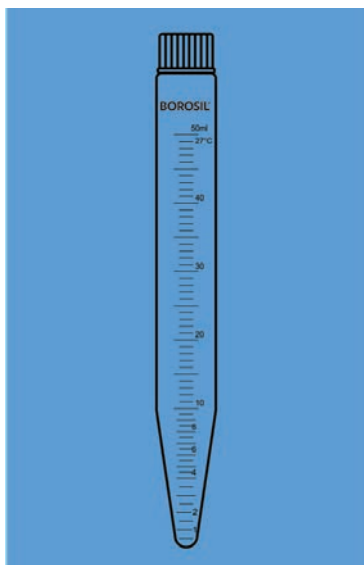

8090 - CENTRIFUGE TUBE

Graduated With PP Screw Cap

- Supplied with screw cap made of polypropylene
- Made of uniformly drawn high quality tubing for extended service life
- Designed with conical bottom for the higher density fraction collection at the bottom of the tube
- Consequently, even small amounts of solids can be collected and separated
- Graduated for greater precision

Product Code	Capacity ml	Approx O.D. x Length mm	Quantity Per Case	Price / Piece ₹
8090007	15	17 x 130	30	702.00
8090012	50	29 x 150	10	931.00

Amber colour Centrifuge tube available Product Code: 8091

8100 - Glass Stoppers

ISO / DIN, Penny head, Clear

Product Code	Stopper Number	Interchangeable Joint Size	Quantity Per Case	Price / Piece ₹
ISO / DIN Standard (Long Neck)				
8100A10	–	10 / 19	20	115.00
8100A12	–	12 / 21	20	120.00
8100A14	–	14 / 23	20	120.00
8100A19	–	19 / 26	20	140.00
8100A24	–	24 / 29	20	270.00
8100A29	–	29 / 32	20	330.00
8100A34	–	34 / 35	20	345.00



8110 - Glass Stoppers

ASTM, Penny head, Clear

Product Code	Stopper Number	Interchangeable Joint Size	Quantity Per Case	Price / Piece ₹
ASTM Standard (Short Neck)				
8110008	# 8	8.25 / 10	20	115.00
8110009	# 9	9.4 / 14	20	130.00
8110013	# 13	13.4 / 14	20	140.00
8110016	# 16	16.5 / 15	20	270.00
8110019	# 19	19.7 / 17	20	330.00
8110022	# 22	22.05 / 20.5	20	345.00
8110027	# 27	27.15 / 21.5	20	360.00

HSN Code : 70179090



8300 - Polypropylene (PP) Stoppers

- Flat head, ISO standard

Product Code	Interchangeable Joint Size	Quantity Per Case	Price / Piece ₹
8300007	7 / 16	20	55.00
8300A10	10 / 19	20	60.00
8300012	12 / 21	20	65.00
8300A14	14 / 23	20	70.00
8300A19	19 / 26	20	80.00
8300A24	24 / 29	20	100.00
8300A29	29 / 32	20	130.00
8300A34	34 / 35	20	145.00

HSN Code : 39235010

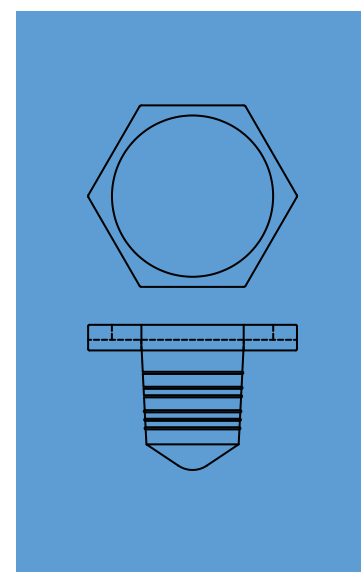

Tubes



8320 - CENTRIFUGE TUBE HEAVY DUTY With Spout, Plain, Short Conical Bottom

- Made of uniformly drawn high quality tubing with increased wall thickness
- Spout allows easy decanting of liquids
- Designed with conical bottom for the higher density fraction collection at the bottom of the tube

Product Code	Capacity ml	Approx O.D. x Length mm	Quantity Per Case	Price / Piece ₹
8320011	40	29 x 116	20	239.00

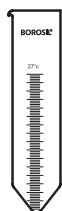

8340 - CENTRIFUGE TUBE HEAVY DUTY With Spout, Graduated, Short Conical Bottom

- Made of uniformly drawn high quality tubing with increased wall thickness
- Spout allows easy decanting of liquids
- Designed with conical bottom for the higher density fraction collection at the bottom of the tube
- Graduated tubes for greater precision

Product Code	Capacity ml	Approx O.D. x Length mm	Quantity Per Case	Price / Piece ₹
8340011	40	29 x 116	20	432.00

Graduated upto 10 ml in 0.5 ml and from 10 ml to 40 ml in 1 ml divisions



8400 - Glass Stoppers ISO / DIN, Penny head, Amber

Product Code	Stopper Number	Interchangeable Joint Size	Quantity Per Case	Price / Piece ₹
ISO / DIN Standard (Long Neck)				
8400A10	–	10 / 19	20	140.00
8400A12	–	12 / 21	20	185.00
8400A14	–	14 / 23	20	185.00
8400A19	–	19 / 26	20	210.00
8400A24	–	24 / 29	20	325.00
8400A29	–	29 / 32	20	380.00
8400A34	–	34 / 35	20	415.00

8410 - Glass Stoppers ASTM, Penny head, Amber

Product Code	Stopper Number	Interchangeable Joint Size	Quantity Per Case	Price / Piece ₹
ASTM Standard				
8410008	# 8	8.25 / 10	20	140.00
8410009	# 9	9.4 / 14	20	150.00
8410013	# 13	13.4 / 14	20	180.00
8410016	# 16	16.5 / 15	20	325.00
8410019	# 19	19.7 / 17	20	400.00
8410022	# 22	22.05 / 20.5	20	420.00
8410027	# 27	27.15 / 21.5	20	435.00



The Adapter tube listed below are the most widely used ones, and will enable a laboratory to assemble its own apparatus using the Flasks and Condensers listed earlier. The joints are fully interchangeable and made to the same precision as all Borosil Scientific ground joints.

Adapters

8800 - ENLARGING CONNECTING ADAPTERS

- An outer interchangeable joint at the top and a smaller inner interchangeable joint at the base
- These joints are made to the same precision as all Borosil Scientific ground joints



Product Code	Socket Joint Size	Cone Joint Size	Quantity Per Case	Price / Piece ₹
8800A01	19 / 26	14 / 23	5	375.00
8800A02	24 / 29	14 / 23	5	465.00
8800A03	24 / 29	19 / 26	5	465.00
8800A04	29 / 32	19 / 26	5	555.00
8800A05	29 / 32	24 / 29	5	555.00
8800A06	34 / 35	19 / 26	5	720.00
8800A07	34 / 35	24 / 29	5	720.00
8800A08	34 / 35	29 / 32	5	720.00



8820 - REDUCTION CONNECTING ADAPTERS

- An outer interchangeable joint at the top and a smaller inner interchangeable joint at the base
- These joints are made to the same precision as all Borosil Scientific ground joints



Product Code	Socket Joint Size	Cone Joint Size	Quantity Per Case	Price / Piece ₹
8820A09	29 / 32	34 / 35	5	725.00
8820A10	14 / 23	19 / 26	5	375.00
8820A11	14 / 23	24 / 29	5	465.00
8820A13	19 / 26	29 / 32	5	555.00
8820A14	19 / 26	34 / 35	5	720.00
8820A15	24 / 29	29 / 32	5	555.00
8820A16	24 / 29	34 / 35	5	720.00
8820A17	29 / 32	40 / 38	5	810.00
8820A18	19 / 26	24 / 29	5	465.00



8830 - RECEIVER BENT ADAPTER WITH VACUUM CONNECTION

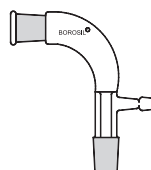

Product Code	Socket Joint Size	Cone Joint Size	Quantity Per Case	Price / Piece ₹
8830614	14 / 23	14 / 23	5	570.00
8830619	19 / 26	19 / 26	5	630.00
8830719	19 / 26	24 / 29	5	665.00
8830624	24 / 29	24 / 29	5	725.00
8830724	24 / 29	29 / 32	5	915.00
8830629	29 / 32	29 / 32	5	1010.00



- Adapters
- Test Tubes
- Sintered Ware
- Quartz Ware

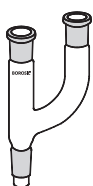

8831 - MULTIPLE ADAPTER With Two Parallel Necks

Product Code	Socket Joint Size	Cone Joint Size	Quantity Per Case	Price / Piece ₹
8831614	14 / 23	14 / 23	5	395.00
8831619	19 / 26	19 / 26	5	430.00
8831719	19 / 26	24 / 29	5	480.00
8831624	24 / 29	24 / 29	5	520.00
8831819	19 / 26	34 / 35	5	610.00
8831629	29 / 32	29 / 32	5	675.00

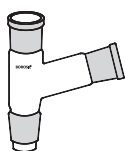

8832 - MULTIPLE ADAPTER With Two Necks

- With two neck - one Vertical & one at 45°

Product Code	Socket Joint Size	Cone Joint Size	Quantity Per Case	Price / Piece ₹
8832619	19 / 26	19 / 26	5	430.00
8832719	19 / 26	24 / 29	5	455.00
8832819	19 / 26	34 / 35	5	555.00

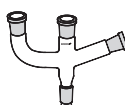

8833 - MULTIPLE ADAPTER With Three Necks

- With three necks - two parallel necks & one at 45°

Product Code	Socket Joint Size	Cone Joint Size	Quantity Per Case	Price / Piece ₹
8833A19	19 / 26	24 / 29	5	630.00
8833B19	19 / 26	29 / 32	5	725.00
8833C19	19 / 26	34 / 35	5	830.00
8833D19	19 / 26	45 / 40	5	1065.00

8834 - SWAN NECK ADAPTER

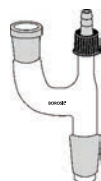

Product Code	Socket Joint Size	Cone Joint Size	Quantity Per Case	Price / Piece ₹
8834619	19 / 26	19 / 26	5	420.00
8834719	19 / 26	24 / 29	5	330.00
8834624	24 / 29	24 / 29	5	510.00
8834724	24 / 29	34 / 35	5	595.00



8835 - ADAPTER CONE / RUBBER TUBING

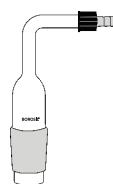

Product Code	Socket Joint Size	Quantity Per Case	Price / Piece ₹
8835A10	10 / 19	5	225.00
8835A14	14 / 23	5	245.00
8835A19	19 / 26	5	295.00
8835A24	24 / 29	5	330.00
8835A29	29 / 32	5	455.00



8836 - ADAPTER CONE - FLEXIBLE TUBING



Product Code	Socket Joint Size	Quantity Per Case	Price / Piece ₹
8836A14	14 / 23	5	245.00
8836A19	19 / 26	5	290.00
8836A24	24 / 29	5	330.00
8836A29	29 / 32	5	410.00
8836B10	10 / 19	5	270.00
8836B14	14 / 23	5	370.00
8836B19	19 / 26	5	370.00
8836B24	24 / 29	5	430.00
8836B29	29 / 32	5	520.00





8837 - ADAPTER RECEIVER Straight Socket To Rubber

Product Code	Socket Joint Size	Quantity Per Case	Price / Piece ₹
8837A14	14 / 23	5	245.00
8837A19	19 / 26	5	290.00
8837A24	24 / 29	5	320.00
8837A34	34 / 35	5	420.00

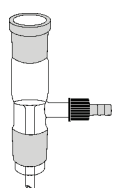

8838 - ADAPTER RECEIVER Straight With Vacuum

Product Code	Socket Joint Size	Cone Joint Size	Quantity Per Case	Price / Piece ₹
8838614	14 / 23	14 / 23	5	330.00
8838714	14 / 23	19 / 26	5	350.00
8838814	14 / 23	24 / 29	5	430.00
8838619	19 / 26	19 / 26	5	420.00
8838719	19 / 26	24 / 29	5	455.00
8838624	24 / 29	24 / 29	5	505.00
8838724	24 / 29	29 / 32	5	610.00



8839 - ADAPTER RECEIVER Bent With Vent

Product Code	Socket Joint Size	Cone Joint Size	Quantity Per Case	Price / Piece ₹
8839614	14 / 23	14 / 23	5	330.00
8839619	19 / 26	19 / 26	5	380.00
8839719	19 / 26	24 / 29	5	455.00
8839624	24 / 29	24 / 29	5	505.00
8839629	29 / 32	29 / 32	5	725.00

8840 - ADAPTER CONES SCREW THREAD

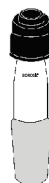

Product Code	Socket Joint Size	Quantity Per Case	Price / Piece ₹
8840A14	14 / 23	5	350.00
8840A19	19 / 26	5	350.00
8840A24	24 / 29	5	410.00
8840A29	29 / 32	5	530.00



8841 - SLOPPING PLANE STILL HEAD

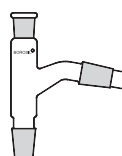

Product Code	Flask Cone	Cond. Cone	Socket	Quantity Per Case	Price / Piece ₹
8841610	10 / 19	10 / 19	10 / 19	5	520.00
8841614	14 / 23	14 / 23	14 / 23	5	545.00
8841619	19 / 26	19 / 26	14 / 23	5	620.00
8841819	19 / 26	19 / 26	19 / 26	5	655.00
8841724	24 / 29	19 / 26	14 / 23	5	690.00
8841624	24 / 29	24 / 29	19 / 26	5	750.00
8841729	29 / 32	19 / 26	14 / 23	5	765.00
8841629	29 / 32	29 / 32	14 / 23	5	1095.00
8841634	34 / 35	19 / 26	14 / 23	5	880.00
8841734	34 / 35	24 / 29	14 / 23	5	1030.00
8841834	34 / 35	34 / 35	14 / 23	5	2945.00



8844 - ADAPTER RECEIVER

Multiple Connectivity

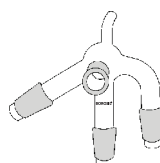

Product Code	Socket Joint Size	Cone Joint Size	Quantity Per Case	Price / Piece ₹
8844614	14 / 23	14 / 23	5	1010.00
8844714	14 / 23	19 / 26	5	1065.00
8844619	19 / 26	19 / 26	5	1185.00



Adapters

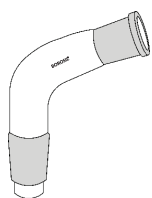

8845 - ADAPTER RECEIVER Plain Bent

Product Code	Socket Joint Size	Cone Joint Size	Quantity Per Case	Price / Piece ₹
8845619	19 / 26	19 / 26	5	380.00
8845719	19 / 26	24 / 29	5	420.00
8845624	24 / 29	24 / 29	5	505.00
8845629	29 / 32	29 / 32	5	725.00

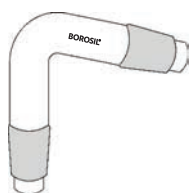

8846 - ADAPTER RECOVERY BENT With Sloping End

Product Code	Socket Joint Size	Cone Joint Size	Quantity Per Case	Price / Piece ₹
8846614	14 / 23	14 / 23	5	290.00
8846724	24 / 29	14 / 23	5	380.00
8846619	19 / 26	19 / 26	5	380.00
8846824	24 / 29	19 / 26	5	400.00
8846729	29 / 32	19 / 26	5	520.00
8846734	34 / 35	19 / 26	5	555.00
8846624	24 / 29	24 / 29	5	400.00
8846834	34 / 35	24 / 29	5	620.00
8846634	34 / 35	34 / 35	5	690.00

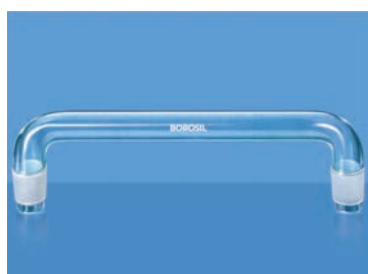

8847 - ADAPTER RECOVERY Bent Vertical

Product Code	Socket Joint Size	Cone Joint Size	Quantity Per Case	Price / Piece ₹
8847614	14 / 23	14 / 23	5	410.00
8847619	19 / 26	19 / 26	5	505.00
8847724	24 / 29	14 / 23	5	530.00
8847624	24 / 29	24 / 29	5	630.00
8847629	29 / 32	29 / 32	5	830.00

8849 - CLAISEN HEAD SLOPING

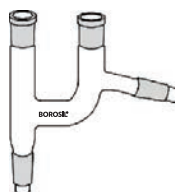

Product Code	Socket Joint Size	Cone Joint Size	Quantity Per Case	Price / Piece ₹
8849614	14 / 23	14 / 23	5	675.00
8849619	19 / 26	19 / 26	5	750.00
8849724	24 / 29	19 / 26	5	790.00
8849624	24 / 29	24 / 29	5	855.00
8849629	29 / 32	29 / 32	5	925.00
8849734	34 / 35	24 / 29	5	985.00

8850 - ADAPTER RECEIVER

Plain Vertical



Product Code	Socket Joint Size	Cone Joint Size	Quantity Per Case	Price / Piece ₹
8850614	14 / 23	14 / 23	5	620.00
8850719	19 / 26	24 / 29	5	675.00
8850724	24 / 29	29 / 32	5	765.00

8851 - SPLASH HEAD

Vertical, Pear Shape

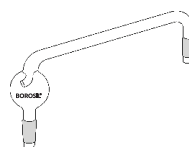

Product Code	Socket Joint Size	Cone Joint Size	Quantity Per Case	Price / Piece ₹
8851619	19 / 26	19 / 26	5	765.00
8851724	24 / 29	19 / 26	5	790.00
8851624	24 / 29	24 / 29	5	985.00
8851629	29 / 32	29 / 32	5	1065.00

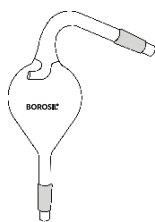

8852 - SPLASH HEAD SLOPING Pear Shape

Product Code	Socket Joint Size	Cone Joint Size	Quantity Per Case	Price / Piece ₹
8852619	19 / 26	19 / 26	5	725.00
8852724	24 / 29	19 / 26	5	765.00
8852624	24 / 29	24 / 29	5	830.00
8852629	29 / 32	29 / 32	5	855.00

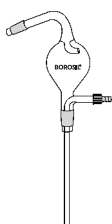

8853 - STEAM DISTILLATION HEADS

Product Code	Socket Joint Size	Cone Joint Size	Quantity Per Case	Price / Piece ₹
8853724	24 / 29	19 / 26	5	1065.00
8853734	34 / 35	19 / 26	5	1305.00
8853834	34 / 35	24 / 29	5	1345.00

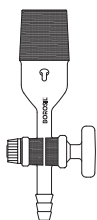

8854 - ADAPTOR Straight cone with stopcock

Product Code	Cone Joint Size	Stopcock Bore mm	Quantity Per Case	Price / Piece ₹
8854014	14 / 23	2	5	1590.00
8854019	19 / 26	2	5	1610.00
8854024	24 / 29	2	5	1715.00
8854029	29 / 32	2	5	1915.00
8854034	34 / 35	2	5	2230.00

8855 - ADAPTOR

Straight Socket With Stopcock

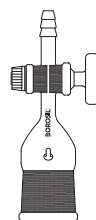

Product Code	Cone Joint Size	Stopcock Bore mm	Quantity Per Case	Price / Piece ₹
8855014	14 / 23	2	5	1840.00
8855019	19 / 26	2	5	1850.00
8855024	24 / 29	2	5	1985.00
8855029	29 / 32	2	5	2115.00
8855034	34 / 35	2	5	2530.00

8856 - ADAPTOR

Bent Cone With Stopcock

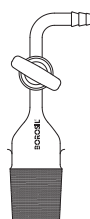

Product Code	Cone Joint Size	Stopcock Bore mm	Quantity Per Case	Price / Piece ₹
8856014	14 / 23	2	5	1840.00
8856019	19 / 26	2	5	1850.00
8856024	24 / 29	2	5	1985.00
8856029	29 / 32	2	5	2115.00
8856034	34 / 35	2	5	2400.00

8857 - ADAPTOR

Bent Socket With Stopcock

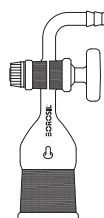

Product Code	Cone Joint Size	Stopcock Bore mm	Quantity Per Case	Price / Piece ₹
8857014	14 / 23	2	5	1955.00
8857019	19 / 26	2	5	1970.00
8857024	24 / 29	2	5	2100.00
8857029	29 / 32	2	5	2405.00
8857034	34 / 35	2	5	2630.00



8861 - THERMOMETER POCKET Long Type

Product Code	Cone Joint Size	Stopcock Bore mm	Quantity Per Case	Price / Piece ₹
8861014	14 / 23	2	10	465.00
8861019	19 / 26	2	10	595.00
8861024	24 / 29	2	10	660.00
8861029	29 / 32	2	10	1065.00
8861034	34 / 35	2	10	1250.00



8862 - THERMOMETER POCKET Short Type

Product Code	Cone Joint Size	Stopcock Bore mm	Quantity Per Case	Price / Piece ₹
8862014	14 / 23	2	10	520.00
8862019	19 / 26	2	10	630.00
8862024	24 / 29	2	10	720.00

Still using
non-certified vials for
storage of expensive
working standards ?

BOROSIL[®]
Scientific
is right here with a solution

PROUDLY MADE IN
india

Certified Sampling and Storage Vials

*An ideal container for storage of
working standard solutions*



Made from 5.1 Low Expansion
Borosilicate Glass



Test Tubes



9800 - TEST TUBES

With Rim

- Complies with IS 2618, DIN / ISO 4142
- Designed with a round bottom and a rim
- Made thick-walled, mechanically very resistant
- High thermal shock resistance



Product Code	Capacity ml	Approx O.D. x Length mm	Quantity Per Case	Price / Piece ₹
9800U01	3	10 x 75	800	11.00
9800U02	5	12 x 75	800	11.00
9800U03	7	12 x 100	800	15.00
9800U15	4	13 x 55*	800	17.00
9800U04	13	15 x 125	800	19.00
9800U05	15	15 x 150	400	22.00
9800U06	27	18 x 150	400	23.00
9800U07	38	25 x 100#	200	29.00
9800U08	55	25 x 150	200	35.00
9800U09	70	25 x 200	100	46.00
9800U10	100	32 x 200	50	69.00
9800U11	170	38 x 200	50	83.00

* IS : 3740 for tube widal

Not covered in the standard

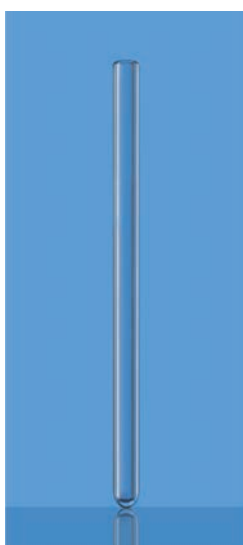

9801 - TUBE FOR CULTURE COLLECTION

- Designed with a round bottom
- Thick walled and high mechanical resistance
- High thermal shock resistance
- Used for blood and microbial culturing

Product Code	Approx O.D. x Length mm	Quantity Per Case	Price / Piece ₹
9801U01	7 x 127	200	31.00

9820 - TEST TUBES

Without Rim

- Complies with IS 2618, DIN / ISO 4142
- Designed with a round bottom and without rim
- Made thick-walled, mechanically very resistant
- High thermal shock resistance



Product Code	Capacity ml	Approx O.D. x Length mm	Quantity Per Case	Price / Piece ₹
9820U16	1	7 x 60*	800	10.00
9820U01	3	10 x 75***	800	10.00
9820U02	5	12 x 75**/**	800	10.00
9820U03	7	12 x 100***	800	15.00
9820U17	8	12 x 125***	800	16.00
9820U04	13	15 x 125	800	19.00
9820U05	15	15 x 150	400	22.00
9820U12	12	16 x 100***	800	21.00
9820U18	20	16 x 150***	400	26.00
9820U06	27	18 x 150	400	23.00
9820U19	25	19 x 125***	400	26.00
9820U07	38	25 x 100#	200	29.00
9820U08	55	25 x 150***	200	35.00
9820U09	70	25 x 200	100	46.00
9820U10	100	32 x 200	50	69.00
9820U11	170	38 x 200	50	83.00

* IS:3740 - 1966 for DURHAM FERMENTATION

** IS:3740 - 1966 for KAHN & WASSERMAN TEST

*** IS:3740 - 1966 for BACTERIOLOGICAL TEST

Not covered in the standard



9821 - DISSOLUTION TUBE

Without Rim

- Designed with flat bottom and without rim
- High thermal shock resistance
- Used for pathological tests and disintegration apparatus



Product Code	Approx O.D. x Length mm	Quantity Per Case	Price / Piece ₹
9821U42	12 x 75	800	26.00
9821U61	18 x 100	400	50.00





9822 - DISSOLUTION TUBE With Rim

- Designed with flat bottom and with rim
- High thermal shock resistance
- Used for pathological tests and disintegration apparatus

Product Code	Approx O.D. x Length mm	Quantity Per Case	Price / Piece ₹
9822U04	14 x 110	800	47.00
9822U13	16 x 98	400	52.00
9822U07	18 x 55	100	42.00
9822U08	18 x 100	200	52.00
9822U06	18 x 138	400	57.00
9822U19	19 x 103	200	62.00

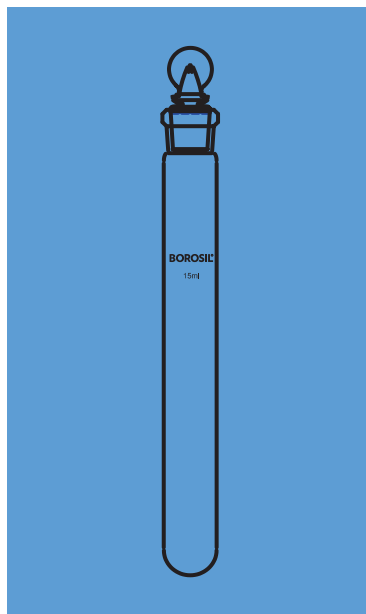

9829 - TEST TUBE

Plain, With I/C Glass Stopper

- Supplied with interchangeable glass stopper
- Made thick-walled, mechanically very resistant
- High thermal shock resistance

Product Code	Capacity ml	Approx O.D. x Length mm	Stopper Size	Quantity Per Case	Price / Piece ₹
9829006	10	17 x 160	10 / 19	10	245.00
9829007	15	19 x 150	14 / 23	10	265.00
9829008	20	19 x 160	14 / 23	10	285.00
9829010	30	25 x 155	19 / 26	10	295.00
9829012	50	25 x 200	19 / 26	10	315.00
9829016	100	34 x 210	24 / 29	10	470.00



9830 - GRADUATED TEST TUBE

With I/C Glass Stopper

- Supplied with interchangeable glass stopper
- Graduations in amber enamel
- Made thick-walled, mechanically very resistant
- High thermal shock resistance
- These test tubes are graduated for greater precision

Product Code	Capacity ml	Approx O.D. x Length mm	Stopper Size	Quantity Per Case	Price / Piece ₹
9830006	10	17 x 160	10 / 19	10	265.00
9830007	15	19 x 150	14 / 23	10	302.00
9830008	20	19 x 160	14 / 23	10	317.00
9830010	30	25 x 155	19 / 26	10	328.00
9830012	50	25 x 200	19 / 26	10	343.00
9830016	100	34 x 210	24 / 29	10	510.00

9831 - GRADUATED TEST TUBE

With I/C Glass Stopper, Amber

- Supplied with interchangeable glass stopper
- Graduations in white enamel
- Amber coating on exterior surfaces to facilitate use with light sensitive solutions
- Made thick-walled, mechanically very resistant
- High thermal shock resistance
- These test tubes are graduated for greater precision

Product Code	Capacity ml	Approx O.D. x Length mm	Stopper Size	Quantity Per Case	Price / Piece ₹
9831006	10	17 x 160	10 / 19	10	385.00
9831007	15	19 x 150	14 / 23	10	410.00
9831008	20	19 x 160	14 / 23	10	420.00
9831010	30	25 x 155	19 / 26	10	465.00
9831012	50	25 x 200	19 / 26	10	490.00
9831016	100	34 x 210	24 / 29	10	690.00

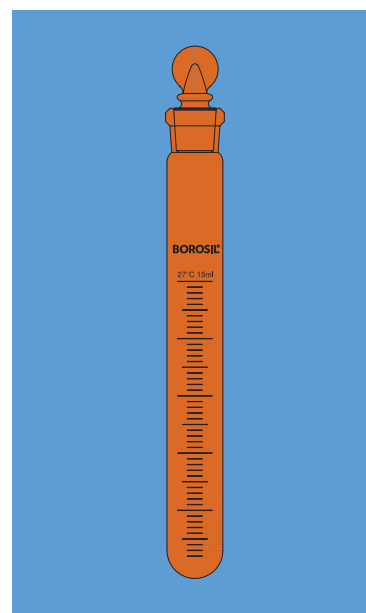

9835 - COD DIGESTION TUBE

- Made from thick-walled and mechanically resistant borosilicate glass
- Used in COD disintegration



Product Code	Approx O.D. x Length mm	Quantity Per Case	Price / Piece ₹
9835A01	36 x 205	10	551.00
9835001	39 x 205	10	551.00



Stirrer Rod / Culture Tubes

Stirrers are used in laboratories for mixing of liquids and decanting the supernatants. Stir rods with blade helps in creating some turbulence and allows efficient mixing of solutions. BOROSIL Scientific stirrers are made of 3.3 borosilicate glass and equipped with a chemically inert PTFE blade to maintain the purity of substances while mixing.

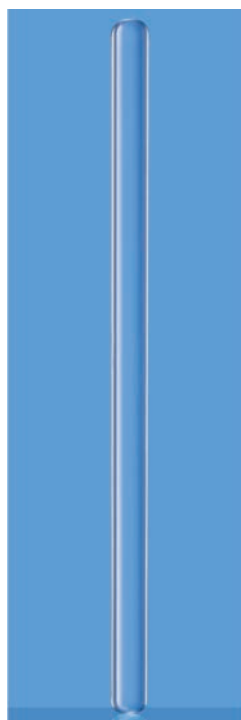

9850 - GLASS STIRRER ROD

Product Code	Approx O.D. x Length mm	Quantity Per Case	Price / Piece ₹
9850107	7 x 150	20	35.00
9850207	7 x 205	20	45.00
9850307	7 x 255	20	45.00
9850407	7 x 305	20	70.00
9850109	9 x 150	20	45.00
9850209	9 x 205	20	70.00
9850309	9 x 255	20	80.00
9850409	9 x 305	20	80.00

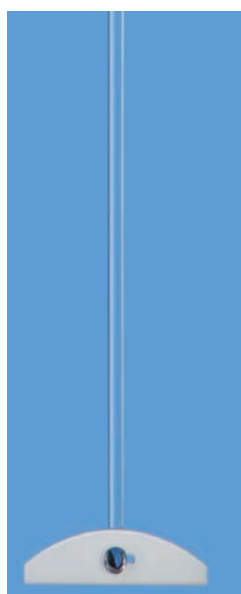

9860 - GLASS STIRRER ROD With PTFE Blade

- Provided with chemically inert PTFE blade
- Ideal for very sensitive samples
- Application in synthetic laboratory

Product Code	Shaft Dia x Length mm	Blade width mm	Socket	Suitable for flask capacity	Quantity Per Case	Price / Piece ₹
9860065	6 x 450	50	19 / 26	500 ml	10	445.00
9860071	6 x 450	75	24 / 29	1000 ml	10	555.00
9860077	8 x 600	100	34 / 35	2000 ml	5	710.00
9860080	8 x 600	125	34 / 35	5000 ml	5	780.00
9860081	10 x 750	150	55 / 44	10000 ml	5	1395.00
9860087	10 x 750	200	55 / 44	20000 ml	5	1555.00

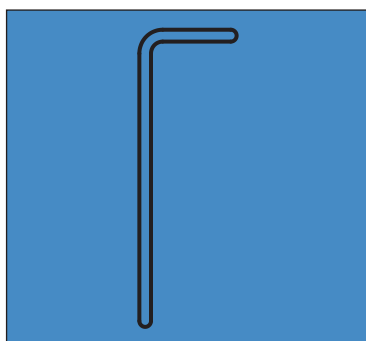

9865 - GLASS L SHAPED SPREADER

- Made of 3.3 borosilicate glass
- Smooth glass surface hence no chances of agar layer disruption while spreading
- Easy to clean and autoclavable at 121°C
- Used for inoculating microbial cultures on agar plates

Product Code	Approx OD x Length mm	Quantity Per Case	Price / Piece ₹
9865683	6 x 150	100	95.00

9900 - CULTURE TUBES

Round Bottom, Clear, With PP Cap

- Supplied with polypropylene cap and PTFE Liner (except 150 ml), autoclavable at 121°C
- Designed with special caps to facilitate handling and sealing
- The ideal replacement for media culture bottles

Product Code	Capacity ml	Approx O.D. x Length mm	Quantity Per Case	Price / Piece ₹
9900005	5	16 x 75	100	73.00
9900006	10	16 x 125	100	78.00
9900010	30	25 x 100	100	94.00
9900012	50	25 x 150	50	99.00
9900013	60	25 x 200	50	99.00
9900018	150#	38 x 200	50	225.00

All caps are Polypropylene with PTFE liner, except 150 ml

#Blue colour cap without PTFE liner & autoclavable up to 140°C



9901 - CULTURE TUBES

Round Bottom, Amber, With PP Cap

- Supplied with polypropylene cap and PTFE Liner (except 150 ml), autoclavable at 121°C
- The uniform amber colour is highly durable and protects light sensitive media and solutions
- Designed with special caps to facilitate handling and sealing
- The ideal replacement for media culture bottles

Product Code	Capacity ml	Approx O.D. x Length mm	Quantity Per Case	Price / Piece ₹
9901005	5	16 x 75	100	125.00
9901006	10	16 x 125	100	166.00
9901010	30	25 x 100	100	182.00
9901013	60	25 x 200	50	239.00
9901018	150#	38 x 200	50	1071.00

All caps are Polypropylene with PTFE liner, except 150 ml

#Blue colour cap without PTFE liner & autoclavable up to 140°C

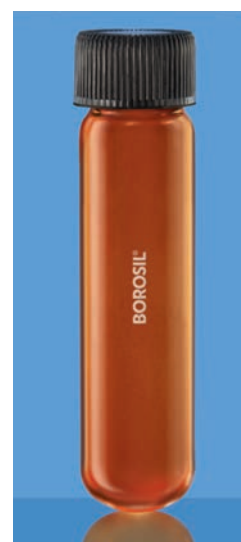

9910 - CULTURE TUBE

Flat Bottom, Clear, With PP Cap

- Supplied with polypropylene cap and PTFE Liner (except 150 ml), autoclavable at 121°C
- Designed with flat bottom for convenient storage and special caps to facilitate handling and sealing
- The ideal replacement for for Bijou, Mc Cartney and universal bottles

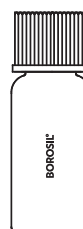

Product Code	Capacity ml	Approx O.D. x Length mm	Quantity Per Case	Price / Piece ₹
9910005	5	16 x 50	100	68.00
9910006	10	25 x 50	100	83.00
9910007	15	25 x 57	100	83.00
9910008	20	25 x 72	100	88.00
9910010	30	25 x 95	100	94.00
9910012	50	25 x 145	50	99.00



Stirrer Rod /
Culture Tubes



9911 - CULTURE TUBE

Flat Bottom, Amber, With PP Cap

- Supplied with polypropylene cap and PTFE Liner (except 150 ml), autoclavable at 121°C
- The uniform amber colour is highly durable and protects light sensitive media and solutions
- Designed with flat bottom for convenient storage and special caps to facilitate handling and sealing
- The ideal replacement for for Bijou, Mc Cartney and universal bottles

Product Code	Capacity ml	Approx O.D. x Length mm	Quantity Per Case	Price / Piece ₹
9911005	5	16 x 50	100	125.00
9911006	10	25 x 50	100	172.00
9911007	15	25 x 57	100	172.00
9911008	20	25 x 72	100	203.00
9911010	30	25 x 95	100	213.00



9913 - CERTIFIED SAMPLING & STORAGE VIALS

- Made of 5.1 expansion borosilicate glass conforming to USP type I, ASTM E438
- Supplied with high quality polypropylene cap with a PTFE liner, autoclavable at 121°C
- Write on patch for easy labelling and identification
- Complies glass composition and spectral transmission test as per USP chapter 660 USP 40 ad EP 9.0
- Packed in ISO "Class 8" clean room facility
- Supplied in amber and clear form
- Amber colour protects light sensitive materials
- Ideal for storage of working standards, sampling of raw materials, chemical and biological samples

Product Code	Capacity ml	Approx Mouth ID in mm	Dimension O.D. x Length in mm	Case Lot (MOQ)	Price Per Piece ₹
9913003	3	10	16 x 36	1050	36.00
9913005	5	10	16 x 55	1050	42.00
9913006	10	16.5	24 x 50	600	68.00
9913007	15	16.5	24 x 58	600	73.00
9913008	20	16.5	24 x 70	600	88.00
9913010	30	16.5	24 x 95	600	104.00

9914 - CERTIFIED SAMPLING & STORAGE VIAL, CLEAR NEW

- Bullet points common for both 9913 and 9914

Product Code	Capacity ml	Approx Mouth ID in mm	Dimension O.D. x Length in mm	Case Lot (MOQ)	Price Per Piece ₹
9914003	3	10	16 x 36	1050	26.00
9914005	5	10	16 x 55	1050	32.00
9914006	10	16.5	24 x 50	600	42.00
9914007	15	16.5	24 x 58	600	48.00
9914008	20	16.5	24 x 70	600	54.00
9914010	30	16.5	24 x 95	600	64.00



Watch Glass

Watch glasses are used most often in chemical laboratories for different applications such as evaporating liquids, weighing of substances, covers for beakers to prevent contamination. BOROSIL Scientific watch glass is designed with an optimum concave to suit these applications.

9986 - WATCH GLASSES

S - Line

- Made of sodalime glass
- A special process is used that results in an absolutely flat curved surface
- High clarity, free of bubbles
- All of them are moulded to the same radius of curvature for convenient stacking

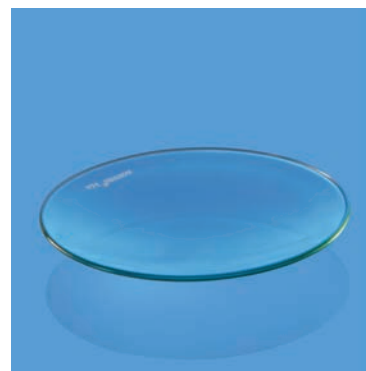
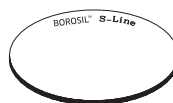

Product Code	Size mm	Quantity Per Case	Price / Piece ₹
9986072	80	50	115.00
9986077	100	50	130.00
9986079	120	20	140.00
9986081	150	20	185.00

Sintered Ware

Technical Data

Borosil Sintered Glassware is used for filtration of liquids and gases in the laboratory. It has a non-corrosive and reusable porous glass disc as the filter media. It is also used for gas washing, dispersion and absorption.

The Sintered Disc is manufactured by crushing Borosil glass, and then powdering, cleaning and separating it into various mesh sizes, and finally, fusing it together in the form of a Disc. Sintered Discs are classified into 5 grades - G1, G2, G3, G4 and G5. The grades are defined in terms of the maximum pore size that is obtained by measuring the pressure at which the first air bubble breaks away from the filter, under specified conditions. The pressure differential is then used to calculate the equivalent capillary diameters in microns. The desired pore size is obtained by controlling the grain size, firing time, temperature and thickness of the Disc. Each Disc is tested and graded individually.

The pore diameters are reasonably uniform, which ensures the required flow rate through the filter. The flow rate further depends on the pressure differential between the two sides of the Disc, the free area of the Disc, viscosity of the fluid being filtered, and other factors. There is a fair amount of uniformity in the pore size of different Discs of the same size and grade. Hence, the results from two or more Discs of the same size and grade will be uniform, thereby ensuring reproducible analytical results.

The Discs have maximum surface hardness and hence, the glass powder does not get scraped off while cleaning or with chemicals. The filters do not shed particles during usage.

The Discs are sealed to tubing without blocking the pores. They are then annealed properly in automatically controlled Lehrs.

Porosity Grades And Their General Use

Porosity Grade	Pore Size (Microns)	General use
1	90-150	Filtration of coarse materials / precipitates, gas dispersion, gas washing, extractor bed, support for other filter materials.
2	40-90	Filtration of medium precipitates gas dispersion, gas washing.
3	15-40	Filtration of fine grain precipitates. Analytical work with medium precipitates. Mercury filtration
4	5-15	Analytical work with fine and very fine precipitates. Non return mercury valves.
5	1-2	Bacteriological filtration.

Chemical Durability

Borosil Sintered Ware is manufactured with the same high quality material of which all Borosil brand borosilicate laboratory glassware is made, ensuring excellent resistance to chemical attack.

Operating Pressure

Sintered Discs, and the glassware that incorporates them, are designed mainly for the application of vacuum or for passage of gases at relatively low pressure. In all cases, the differential pressure must not exceed 100 KN / m² (15 psi).

Thermal Limitations

Sintered Ware has a lower level of resistance to thermal shock as compared to standard Borosil glassware. Therefore, articles of Sintered Ware should not be subjected to excessive temperature changes or direct flames.

Borosil Sintered Crucibles are especially suitable for drying to constant weight. Dry Sintered Crucibles at room temperature, can be placed directly into a drying oven. Sintered Ware may safely be heated in a furnace to 500°C without any adverse effects, while ensuring that the cycle of heating and cooling is gradual. It is recommended that the rate of heating does not exceed 20°C/min. This prevents internal strains caused by excessive temperature differences between the surrounding glass vessel and the Sintered Disc that, in turn, can lead to fracture of the apparatus.

When cold and damp, Sintered Ware of porosity grades 4 and 5 should never be subjected to a sudden temperature change as the evolution of steam may generate pressure within the filter, sufficient to crack it.

Filtration Apparatus should be kept on its rim (stem upwards) in an oven or steriliser. A perforated support base is advantageous for air convection in case of pipeline filters. By using heat insulating material such as asbestos, care should be taken to avoid premature heating near the filter seal. The apparatus should remain in the oven or steriliser during cooling, to prevent excessively fast cooling.

Cleaning Of Sintered Ware

New Sintered Filters should be washed carefully with hot hydrochloric acid, and then rinsed with distilled water before use. Such treatment ensures that all loose particles are removed from the Filter.

It is advisable to clean all Sintered Filters thoroughly, immediately after use, as cleaning is easiest at this time, and it also reduces the risk of contamination in the next use.

Many precipitates can be removed from the filter by back-flushing with water. However, great care must be taken with large diameters and fine filters, as positive pressures on the reverse side may break the filter.

Under no circumstances should Sintered Apparatus be subjected to mains water pressure when back-flushing, as in most instances this leads to fractured filters.

Drawing water through the filter from the reverse side, by means of a vacuum pump, is also effective.

Filters clogged with dust and dirt during gas filtration can be restored by treatment with warm detergent solution, followed by blowing clean air through, from the clean side of the filter. Dirt particles are brought to the surface by the foam, and removed by rinsing with water.

Some precipitates that clog the filter may be removed by chemical cleaning, as indicated below:

- **Fats and grease**
Carbon tetrachloride or suitable organic solvent
- **Albumen glucose:**
Hot ammonia or hydrochloric acid, mixture of hot concentrated sulphuric and nitric acids
- **Organic substances :**
'Chromic' acid cleaning solution* or concentrated sulphuric acid containing a little potassium nitrate or perchlorate (0.5%) (may need to be soaked overnight)
- **Copper or iron oxide :**
Hot concentrated hydrochloric acid with potassium chlorate.
- **Barium sulphate :**
Hot concentrated sulphuric acid
- **Mercury Residues :**
Hot concentrate nitric acid
- **Mercury Sulphide :**
Hot aqua regia
- **Silver chloride :**
Ammonia or sodium hyposulphite
- **Stannic oxide :**
Boiling sulphuric acid**

Alumina or silica residues :

2% hydrofluoric acid followed by concentrated sulphuric acid. Rinse immediately with distilled water and then with acetone. Continue rinsing until no trace of acid remains.

High concentrations of hydrofluoric acid, hot phosphoric acid or caustic alkali solutions should never be used for cleaning. Using these causes a rapid deterioration in the filter and an increase in pore size.

* For bacteriological, pharmaceutical and biological work, 'chromic' acid cleaning solution should be avoided in view of the biological effect of chromium ions.

** Boiling sulphuric acid may introduce undue thermal strain. It is therefore advisable to leave the item in the acid to cool.

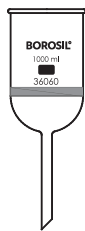

36060 - BUCHNER FUNNEL

With Sintered Disc

- Made of 3.3 borosilicate glass
- Especially useful where the filter paper may be attacked by filtered material
- Generally used in qualitative inorganic analysis and preparative chemistry
- Resistant to corrosion and heat

Product Code	Capacity ml	Porosity Grade	Dia of Disc mm	Approx Height mm	Stem Dia mm	Quantity Per Case	Price / Piece ₹
3606058	35	1	30	130	8	5	705.00
3606658	35	2	30	130	8	5	670.00
3606758	35	3	30	130	8	5	705.00
3606858	35	4	30	130	8	5	670.00
3606958	35	5	30	130	8	5	845.00
3606072	80	1	35	142	8	5	1305.00
3606672	80	2	35	142	8	5	1305.00
3606772	80	3	35	142	8	5	1305.00
3606872	80	4	35	142	8	5	1305.00
3606972	80	5	35	142	8	5	1580.00
3606020	200	1	68	215	13	5	2030.00
3606620	200	2	68	215	13	5	2030.00
3606720	200	3	68	215	13	5	2030.00
3606820	200	4	68	215	13	5	2030.00
3606920	200	5	68	215	13	5	2365.00
3606024	500	1	92	258	17	2	4790.00
3606624	500	2	92	258	17	2	4790.00
3606724	500	3	92	258	17	2	4790.00
3606824	500	4	92	258	17	2	4790.00
3606924	500	5	92	258	17	2	6270.00
3606029	1000	1	124	276	19	2	9260.00
3606629	1000	2	124	276	19	2	9260.00
3606729	1000	3	124	276	19	2	9260.00
3606829	1000	4	124	276	19	2	9260.00
3606929	1000	5	124	276	19	2	11840.00

32060 - GOOCH CRUCIBLE

Low Form, With Sintered Disc

- Made of 3.3 borosilicate glass
- Particularly adapted to analytical work where precipitates are dried to constant weight at 110°C
- Crucibles should not be subjected to sudden temperature changes
- In order to avoid strain, they should not be removed from the furnace until the temperature has dropped to 250°C
- Gooch Crucible is used for metal casting and analysis

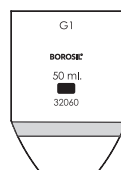

Product Code	Capacity ml	Porosity Grade mm	Dia of Disc mm	Approx Height	Quantity Per Case	Price / Piece ₹
3206007	15	1	20	50	10	485.00
3206607	15	2	20	50	10	485.00
3206707	15	3	20	50	10	485.00
3206807	15	4	20	50	10	485.00
3206907	15	5	20	50	10	595.00
3206010	30	1	30	60	10	645.00
3206610	30	2	30	60	10	645.00
3206710	30	3	30	60	10	645.00
3206810	30	4	30	60	10	645.00
3206910	30	5	30	60	10	795.00
3206012	50	1	40	65	10	745.00
3206612	50	2	40	65	10	745.00
3206712	50	3	40	65	10	745.00
3206812	50	4	40	65	10	745.00
3206912	50	5	40	65	10	930.00

32061 - TUBE FOR GOOCH CRUCIBLE

- Made of 3.3 borosilicate glass
- Suitable for use with Borosil's Scientific Gooch Crucible with sintered disc



Product Code	Approx O.D. x Length mm	Quantity Per Case	Price / Piece ₹
3206127	27 x 150	5	215.00
3206136	36 x 160	5	305.00
3206156	56 x 170	10	450.00

These are suitable for use with our filtering crucibles Gooch Type with sintered disc, No. 32060 lower part 8 mm O.D. x 75 mm length in all sizes.



Sintered Ware

Boron Free Transparent Silica

Borosil Fused Silica 99.95% SiO₂ surpasses all of the desirable chemical and weathering durability properties usually associated with opaque Silica ware. We manufacture as per IS and BS Standards.



a) There is little or no visible surface change or damage to silica with prolonged exposure to water, atmospheric gases, contaminants, oxide of nitrogen and ozone.

b) Attack does occur, on exposure to alkaline solution and acids at very high temperatures.

c) Low expansion and hence excellent dimensional stability and thermal shock resistance.



Resistant to chemical attack

Virtually unaffected by sulphuric, nitric and hydrochloric acids. Hot alkalis and certain metal oxides react on silica. It is attacked by hydrofluoric acid. At high temperatures, it is also attacked by phosphoric acid.

Continuous use of fused silica above 1000°C leads to devitrification with formation of cristobalite which is a crystalline phase and will lead to breakage on repeated use. For accurate and long use, it is advisable to wash the articles in distilled water and alcohol to remove trace impurities.

Heating fused quartz to elevated temperatures causes SiO₂ to undergo dissociation. Consequently, when flame-working fused quartz, there is a brand of haze or smoke which forms just outside the intensely heated region. This haze presumably forms because the SiO₂ recombines with oxygen from the air (and perhaps water) and condenses as extremely small particles of amorphous SiO₂.

Co-efficient of expansion 0°C to 800°C

5.5 X 10⁻⁷ cm / cm / °C

Softening Point

1685°C

Annealing Point

1200°C

Strain Point

1120°C

Operating Temp

1050°C

Electrical resistivity (at 350°C)

7 x 10⁷ ohm cm

1002 - QUARTZ LOW FORM BEAKER

With Spout

- Beaker with Spout for Clean Pouring
- Dimensional accuracy
- Tough construction
- Durability

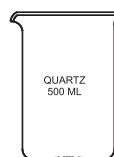

Product Code	Capacity ml	Approx O.D. x Length mm	Quantity Per Case	Price / Piece ₹
1002009	25	35 x 45	5	1805.00
1002012	50	40 x 58	5	2660.00
1002016	100	50 x 75	5	4095.00
1002018	150	55 x 88	5	5300.00
1002021	250	70 x 95	1	7915.00
1002024	500	85 x 115	1	15155.00
1002029	1000	105 x 145	1	26360.00

3164 - QUARTZ PETRI DISHES **NEW**

Product Code	Size mm	LID Approx I.D. (D1) x Height (H1) mm	Bottom Approx O.D. (D2) x Height (H2) mm	Quantity Per Case	Price / Piece ₹
3164077	100 x 17	103 x 15	100 x 17		17250.00

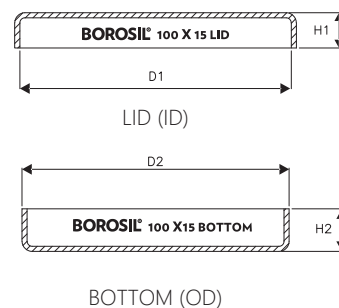

3175 - QUARTZ MUFFLE TRAYS

- Perfect finish
- Sturdiness
- Durability
- Holes: 2/4

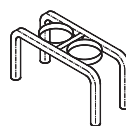

Product Code	Capacity ml	Approx O.D. x Length mm	Quantity Per Case	Price / Piece ₹
3175041	2 Holes	39	1	2380.00
3175042	4 Holes	76	1	4650.00





3185 - QUARTZ ROUND DISHES/BASINS With Spout

- Round with Spout
- Perfect finish
- Accurate dimensions
- Longer life span

Product Code	Approx O.D. x Height mm	Nominal Capacity ml	Quantity Per Case	Price / Piece ₹
3185008	55 x 23	20	10	1560.00
3185042	75 x 27	45	5	4420.00
3185044	85 x 35	70	5	5510.00
3185045	95 x 36	85	1	9130.00
3185016	100 x 38	100	1	10980.00
3185046	115 x 47	200	1	16700.00

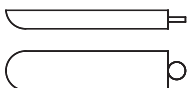

3186 - QUARTZ COMBUSTION BOATS With Handle

- Light in weight
- Longer life span
- Accurate dimensions
- Sturdiness

Product Code	Approx O.D. x Length mm	Quantity Per Case	Price / Piece ₹
3186Q01	12 x 77	1	1460.00

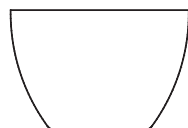

3190 - QUARTZ CRUCIBLES Without Lid

- Accurate dimensions
- Longer life span
- Fine finish
- Sturdiness

Product Code	Capacity ml	Approx O.D. x Length mm	Quantity Per Case	Price / Piece ₹
3190007	15	40 x 26	10	855.00
3190009	25	47 x 30	10	1250.00
3190012	50	57 x 35	10	1995.00
3190015	80	69 x 45	10	3215.00
3190018	150	80 x 54	5	5885.00

3191 - LIDS FOR QUARTZ CRUCIBLES (CAT. NO. 3190)

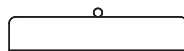

- Accurate dimension
- Longer life span
- Fine finish
- Sturdiness

Product Code	Capacity ml	Quantity Per Case	Price / Piece ₹
3191007	15	10	845.00
3191009	25	10	1200.00
3191012	50	10	1875.00
3191015	80	10	3100.00



3195, 3196 & 3197 - QUARTZ VOLATILE MATTER CRUCIBLES

- Dimensional accuracy
- Tough construction
- Durability
- Comes with Lid and Plunger

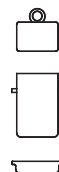

Product Code	Catalogue No.	Item	Dimension mm	Quantity Per Case	Price / Piece ₹
3195041	3195	Crucible	25 x 38	5	2410.00
3196041	3196	Plunger	12.5	5	790.00
3197041	3197	Lid		5	705.00

3198 - QUARTZ SILICA TRIANGLES on Nichrome (Translucent)

- Longer life span
- Sturdiness
- Seamless finish

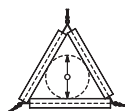

Product Code	Capacity ml	Quantity Per Case	Price / Piece ₹
3198007	15	10	315.00
3198009	25	10	415.00
3198012	50	10	790.00
3198015	80	5	1125.00



4984 - QUARTZ ERLLENMEYER (CONICAL) FLASK

- Suitable for digestion of samples with concentrated acid (except HF)
- Ideal for estimation of boron in soil
- Withstand sudden heating & cooling

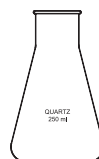

Product Code	Capacity ml	External Dimension		Price / Piece ₹
		O.D. mm	Height mm	
4984016	100	64	105	8280.00
4984018	150	72	124	10185.00
4984021	250	85	140	12890.00



Quartz Ware

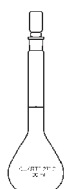

5644 - QUARTZ VOLUMETRIC FLASK With I/C Quartz Stopper, Class B

- Dimensional accuracy
- Sturdiness
- Durability
- Perfect finish

Product Code	Capacity ml	Quantity Per Case	Price / Piece ₹
5644005	5	1	6945.00
5644006	10	1	3985.00
5644009	25	1	4715.00
5644012	50	1	5645.00
5644016	100	1	7290.00
5644021	250	1	10580.00
5644024	500	1	14085.00
5644029	1000	1	28135.00



8600 - QUARTZ CIRCULAR CAPSULE

- Suitable for determination of ash content in coal analysis
- Withstand sudden heating & cooling

Product Code	External Dimension		Price / Piece ₹
	Height mm	Diameter mm	
8600Q01	14	48	1995.00
8600Q02	15	54	2260.00

*The ash content in coal is an important parameter in determining the quality of coal. Ash reduces the calorific value of coals and hence burning coals on a large scale require knowledge of their ash content. Analysis is fairly straight forward, with the coal thoroughly burnt at 750°C to 800°C and the ash material express as a percentage of the original weight. It gives an indication about the quality of coal.

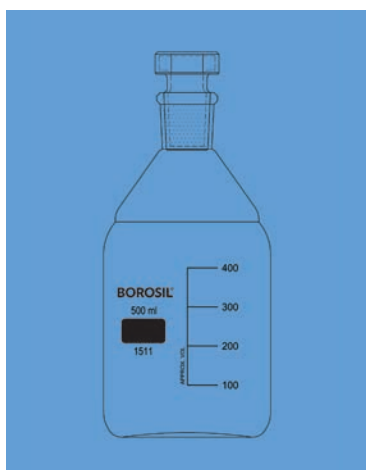

1511 - QUARTZ REAGENT BOTTLE With Hollow Quartz I/C Stopper

Product Code	Capacity ml	Quantity Per Case	Price / Piece ₹
1511024	500	1	22920.00

3028 - QUARTZ MEASURING CYLINDER

With Spout, Class B

Product Code	Capacity ml	Quantity Per Case	Price / Piece ₹
3028005	5	1	9240.00
3028006	10	1	10350.00
3028009	25	1	14045.00
3028012	50	1	21435.00
3028016	100	1	28835.00
3028021	250	1	41400.00
3028024	500	1	56925.00

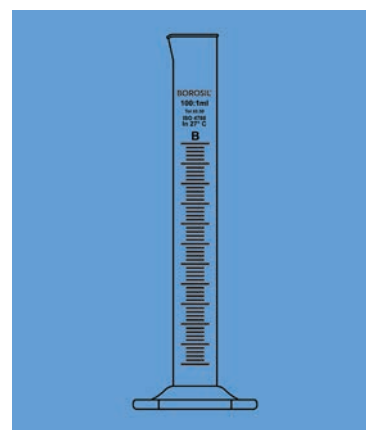

6141 - QUARTZ FILTER FUNNEL, 60°

Product Code	Capacity mm	Quantity Per Case	Price / Piece ₹
6141071	75	1	20270.00

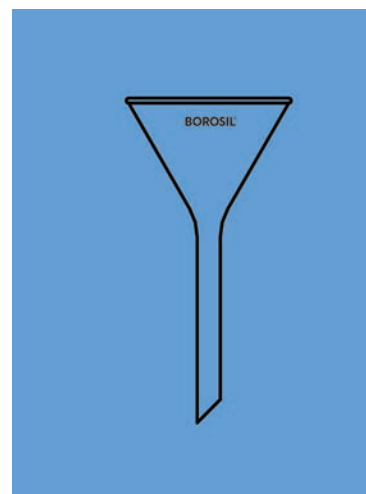

7064 - QUARTZ MOHR GRADUATED PIPETTES, CLASS B

Product Code	Capacity ml	Quantity Per Case	Price / Piece ₹
7064P41	1 x 0.01	1	11980.00
7064P22	2 x 0.1	1	8130.00
7064P55	5 x 0.1	1	10500.00
7064P06	10 x 0.1	1	12565.00

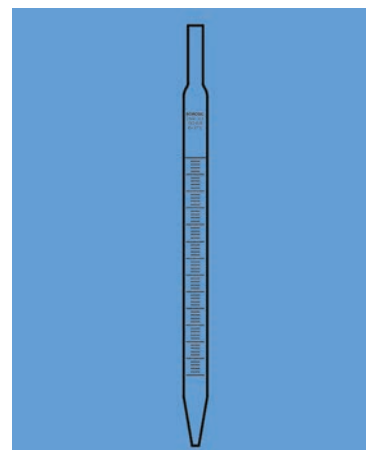

7104 - QUARTZ VOLUMETRIC PIPETTES, CLASS B

Product Code	Capacity ml	Quantity Per Case	Price / Piece ₹
7104001	1	1	9180.00
7104002	2	1	9180.00
7104003	3	1	11900.00
7104004	4	1	11900.00
7104005	5	1	11710.00
7104706	6	1	13170.00
7104006	10	1	13170.00

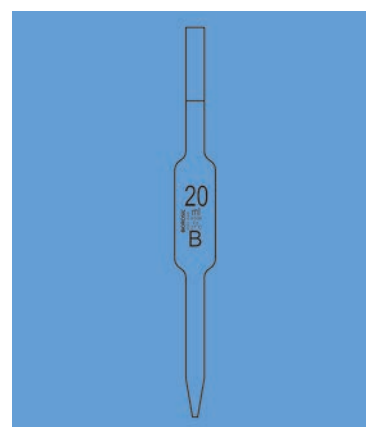

Quartz Ware

Microscope Slides & Cover Glasses



Material

Made of sodalime glass with thickness of 1.0 - 1.2mm

Edges

Finely ground edges at 90deg angle which minimizes the risk of cuts when handling the slides

Surfaces

Slide surface is cleaned with water and dried before packing for the perfect smear preparations

Packaging

Packed in a paper box containing silica desiccant to absorb moisture
50 slides per box and 25 boxes per case

Types

Plain

For routine applications

Frosted

For easy labelling with marker



9100 - MICROSCOPE GLASS SLIDES

- Made from the finest white glass of uniform quality
- Conforms to ISO 8037 standard
- High- precision ground edges on all four sides
- Thin, flat and resistant to corrosion or fogging
- Pre-cleaned and ready to use
- Subjected to strict quality control checks, examined individually and environmentally controlled dry before packaging
- Specially designed for meeting the stringent needs of users
- Free from all visual defects
- Used for routine microscopy applications

Product Code	Description	Dimensions mm L x B x WT	Quantity Per Packet No.	Packets / Case	Price / Packet ₹
9100P02	Plain, Ground Edges	76 x 26 x 1	50	25	125.00
9100D01	Double Frosted, Ground Edges	76 x 26 x 1	50	25	220.00

L : Length x B : Breadth x WT : Wall Thickness

9100P02 - PLAIN



9100D01 - DOUBLE FROSTED



9115 - COVER GLASS

- Made from the finest white glass of uniform quality
- Available in both square and rectangular shape
- Cover glass is cut, cleaned, sorted and weighed
- Resistance to corrosion and fogging
- Free from ragged edges, oily film and finger prints
- Packed in reclosable plastic boxes for protection during storage
- Pre cleaned and ready to use
- Subjected to strict quality control checks, examined individually and environmentally controlled to dry before packaging

Product Code	Description	Dimensions mm	Quantity Per Packet / Piece	Packets / Case	Price / Packet ₹
9115S01	Square	18 x 18	100	50	335.00
9115S02	Square	22 x 22	100	50	495.00
9115S03	Square	24 x 24	100	50	560.00
9115R01	Rectangular	22 x 40	100	50	800.00
9115R02	Rectangular	22 x 50	100	50	930.00
9115R03	Rectangular	22 x 60	100	50	1080.00

9115S01 - SQUARE



9115S02 - SQUARE



9115S03 - SQUARE



9115R01 - RECTANGULAR



9115R02 - RECTANGULAR



9115R03 - RECTANGULAR



BOROSIL[®] Scientific

Analytical Vials & Closures

“for Labs where
compliance matters”

- 2ml HPLC
VIALS/CLOSURES/KIT
- 20ml HEADSPACE GC
VIALS/CLOSURES/KIT
- Certified Pre-assembled
EPA/TOC VIALS/KIT

Why should I choose BOROSIL vials?

No matter which make of instrument you use, it is critical that your sample is carried in a reliable vial.

Whereas, it is important that vials are made within stringent dimensions in controlled conditions to perform consistently, it is even more critical to a Chemist to be able to confidently rule out the vial as a contributor to an OOS (out of specification) incident.

BOROSIL being a manufacturer of vials, provides a Chemist access to the detailed testing & quality documentation of vials thereby enabling a chemist to investigate root causes effectively.

Borosil vials are manufactured in [ISO 15378 \(GMP\)](#) Certified Plant Under Controlled Conditions Online camera for 100% [DIMENSIONAL INSPECTION](#) Class 8 Clean Room packaging to avoid the [RISK OF CONTAMINATION](#)



Quality Assurance



Vial forming Process

On automated machines for utmost consistency

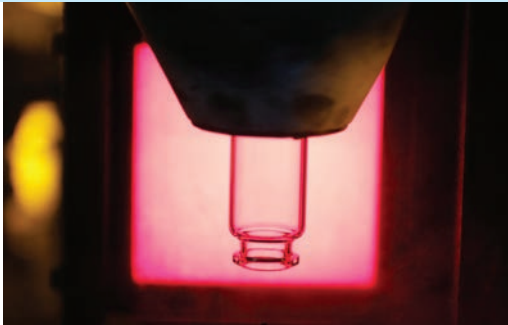

Dimensional Inspection

Online optical inspection to minimize ensure 100% dimensional and cosmetic conformance

Annealing Process

Imparts mechanical strength to the vial

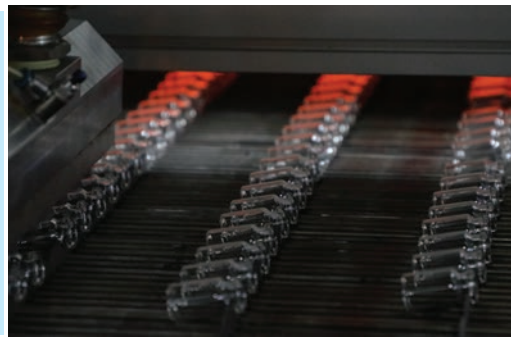

Final Inspection and packing

Packed in ISO Certified Class 8 Clean Room facility with minimum human intervention

Borosil certified Vials are manufactured in an ISO 9001 certified facility, in accordance with US and European Pharmacopoeia.

Easy ordering!!!

The 14 Digit Code

Whether you choose to buy a combipack that includes **Vials** and matching **Closures** or only the glass vial or only the vial closure, **BOROSIL's 14 digit code** makes it very easy in **FOUR** simple steps!

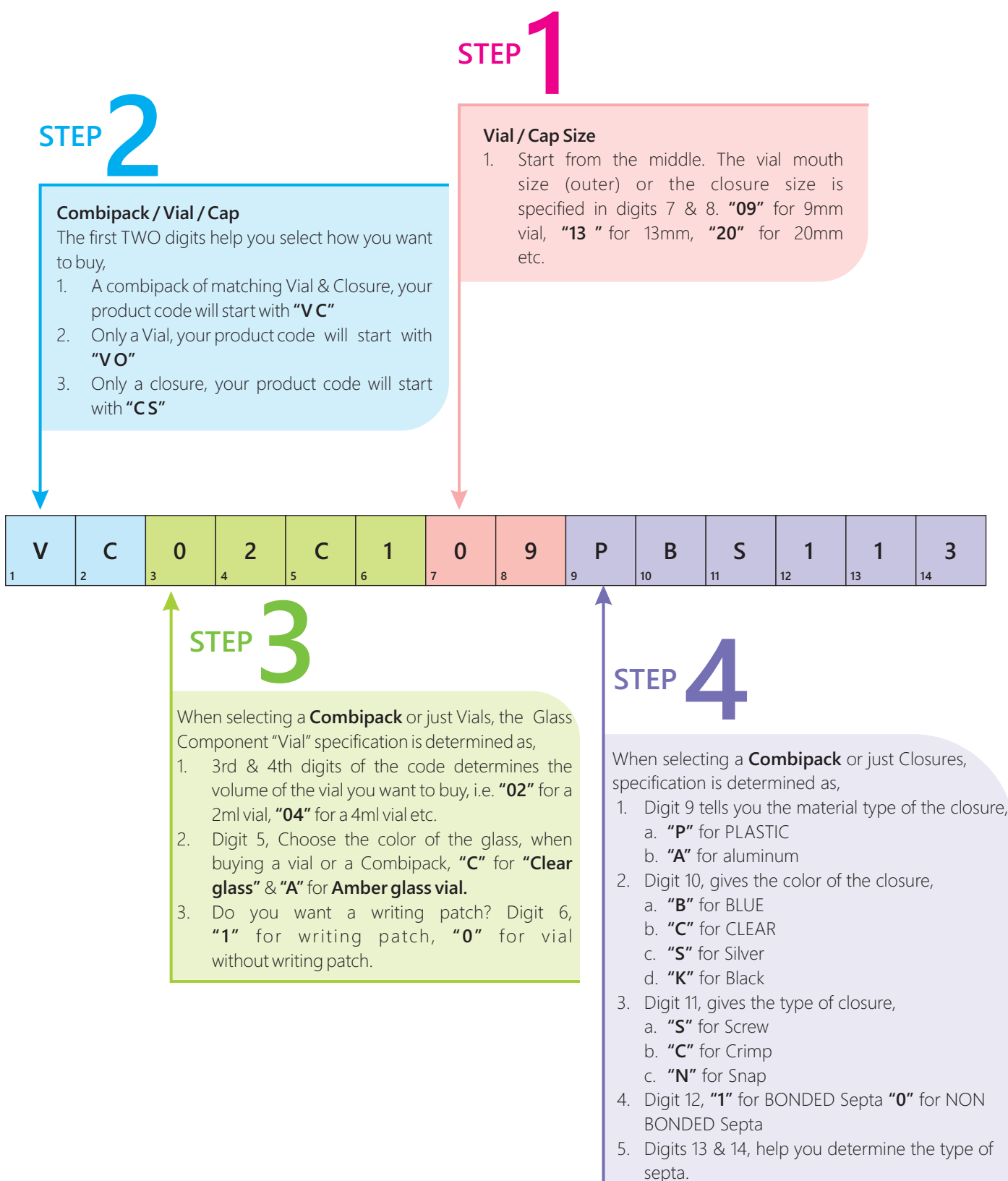

2ml HPLC SAMPLE VIALS & CLOSURES

For 9mm Screw
Cap Vial



For 11mm Screw
Cap Vial



SCREW NECK



CRIMP NECK



Glass vials with closures (COMBPACK)

Product Code	Neck Dia	Septa Feature 1	Graduation with write on patch	Septa Feature 2	Pack Size	Case Lot	List Price Per Pack ₹
9mm Screw Top Clear Vials made from Borosilicate USP Type I 49-Expansion glass with Closure							
Blue PP Cap PTFE-Silicone Septa							
VC02C009PBS124	9mm	Non Slit	NO	Bonded	100	10 X 100	2700.00
VC02C009PBS114	9mm	Pre Slit	NO	Bonded	100	10 X 100	2700.00
VC02C109PBS124	9mm	Non Slit	YES	Bonded	100	10 X 100	2950.00
VC02C109PBS114	9mm	Pre Slit	YES	Bonded	100	10 X 100	2950.00
VC02C109PBS113	9mm	Pre Slit	YES	Bonded	100	10 X 100	3600.00
9mm Screw Top AMBER Vials made from Borosilicate USP Type I 54-Expansion glass with Closure							
Blue PP Cap PTFE-Silicone Septa							
VC02A009PBS124	9mm	Non Slit	NO	Bonded	100	10 X 100	3150.00
VC02A009PBS114	9mm	Pre Slit	NO	Bonded	100	10 X 100	3150.00
VC02A109PBS124	9mm	Non Slit	YES	Bonded	100	10 X 100	3400.00
VC02A109PBS114	9mm	Pre Slit	YES	Bonded	100	10 X 100	3500.00
VC02A109PBS113	9mm	Pre Slit	YES	Bonded	100	10 X 100	4100.00
11mm Crimp Top Clear Vials made from Borosilicate USP Type I 49-Expansion glass with Closure							
Silver Aluminium Crimp PTFE-Silicone Septa							
VC02C011ASC021	11mm	Non Slit	NO	Assembled	100	10 X 100	2200.00
VC02C011ASC022	11mm	Pre Slit	NO	Assembled	100	10 X 100	2400.00
VC02C111ASC021	11mm	Non Slit	YES	Assembled	100	10 X 100	2300.00
VC02C111ASC022	11mm	Pre Slit	YES	Assembled	100	10 X 100	2500.00
11mm Crimp Top AMBER Vials made from Borosilicate USP Type I 54-Expansion glass with Closure							
Silver Aluminium Crimp PTFE-Silicone Septa							
VC02A011ASC021	11mm	Non Slit	NO	Assembled	100	10 X 100	2300.00
VC02A011ASC022	11mm	Pre Slit	NO	Assembled	100	10 X 100	2500.00
VC02A111ASC021	11mm	Non Slit	YES	Assembled	100	10 X 100	2600.00
VC02A111ASC022	11mm	Pre Slit	YES	Assembled	100	10 X 100	2750.00

2ml HPLC SAMPLE VIALS & CLOSURES

Borosilicate USP Type I, 49-Expansion glass vial with Silicone white/PTFE red septa



- 100 % Dimensionally **INSPECTED** & mechanically **STABLE** vial
- **LOW VOLATILE ORGANIC CARBON** containing PTFE-Silicone septa
- Suitable for **ROUTINE** analysis
- **EASY CAPPING** of vial



SCREW NECK



Glass vials with closures (COMBIPACK)

Product Code	Neck Dia	Septa Feature 1	Graduation with write on patch	Septa Feature 2	Pack Size	Case Lot	List Price Per Pack ₹
9mm Screw Top Clear Vials made from Borosilicate USP Type I, 49-Expansion glass with Closure Blue PP Cap PTFE-Silicone Septa							
VC02C009PBS125	9mm	Non Slit	NO	Assembled	100	10 X 100	2300.00
VC02C109PBS125	9mm	Non Slit	YES	Assembled	100	10 X 100	2550.00
9mm Screw Top AMBER Vials made from Borosilicate USP Type I 54-Expansion glass with Closure Blue PP Cap PTFE-Silicone Septa							
VC02A009PBS125	9mm	Non Slit	NO	Assembled	100	10 X 100	2750.00
VC02A109PBS125	9mm	Non Slit	YES	Assembled	100	10 X 100	3000.00

2ml HPLC SAMPLE VIALS & CLOSURES

Borosilicate USP Type I, 49-Expansion glass vial with Silicone white/PTFE red sept



- Excellent **SEALING** and **CHEMICAL RESISTANCE** glass vials
- Snap ring caps are **MORE CONVENIENT** in handling(Pushing on/removal)
- **COMPATIBLE** with all make LC/GC analysis
- **EASY CAPPING** of vial



SCREW NECK

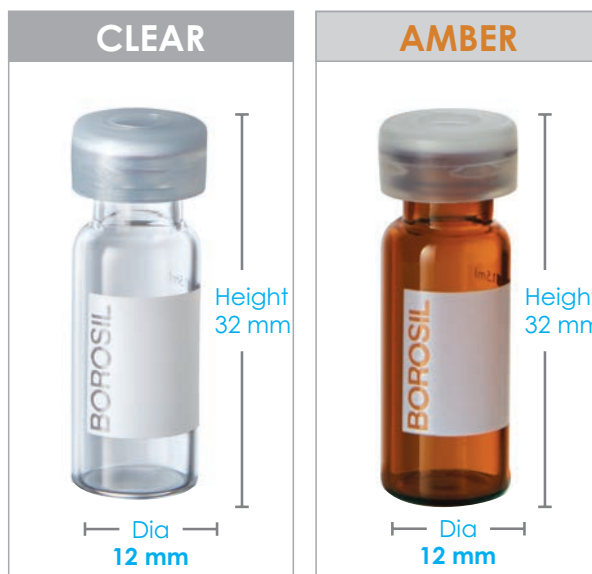

Glass vials with closures (COMBIPACK)

Product Code	Neck Dia	Septa Feature 1	Graduation with write on patch	Septa Feature 2	Pack Size	Case Lot	List Price Per Pack ₹
9mm Crimp Top Clear Vials made from Borosilicate USP Type I 49-Expansion glass with Snap Top Closure Blue PP Cap PTFE-Silicone Septa							
VC02C011PNS011	11 mm	Non Slit	NO	Assembled	100	10 X 100	2200.00
VC02C111PNS011	11 mm	Non Slit	YES	Assembled	100	10 X 100	2300.00
9mm Screw Top AMBER Vials made from Borosilicate USP Type I 54-Expansion glass with Snap Top Closure Blue PP Cap PTFE-Silicone Septa							
VC02A011PNS011	11 mm	Non Slit	NO	Assembled	100	10 X 100	2300.00
VC02A111PNS011	11 mm	Non Slit	YES	Assembled	100	10 X 100	2600.00

2 ml HPLC CERTIFIED CLEAR VIALS & CLOSURES

Borosilicate USP Type I, ASTM Class A 33-Expansion glass vial with ultra pure certified septa

- 3.3-Expansion Borosilicate Type I glass vial with **HIGH SILICON, LOW ALKALI** content (SiO₂ 81%, Na₂O 3-3.5%)
- Leak proof Ultra pure certified **CHEMICALLY INERT** PTFE-Silicone septa
- **CHEMICALLY HIGHLY RESISTANT** glass vial
- **SPECIAL APPLICATIONS** in the pharmaceutical industries



Glass vials with closures (COMBIPACK)

Product Code	Neck Dia	Septa Feature 1	Graduation with write on patch	Septa Feature 2	Pack Size	Case Lot	List Price Per Pack ₹
9mm Screw Top Clear Vials made from Borosilicate USP Type I, ASTM Class A 33-Expansion glass with Closure Blue PP Cap Ultra Pure Certified PTFE-Silicone Septa							
VC02C409PBSUM1	9mm	Pre Slit	YES	Bonded	100	10 X 100	5400.00
VC02C409PBSUM2	9mm	Non Slit	YES	Bonded	100	10 X 100	5400.00
9mm Screw Top Clear Vials made from Borosilicate USP Type I, ASTM Class A 33-Expansion glass with Closure Blue PP Cap High Purity PTFE-Silicone Septa							
VC02C409PBS113	9mm	Pre Slit	YES	Bonded	100	10 X 100	4600.00

Note: Amber vials are available in USP Type I54 - Expansion Glass with above septa combination - prices on request.

Extractable study of vials and septa using LCMS-MS and GCMS Techniques

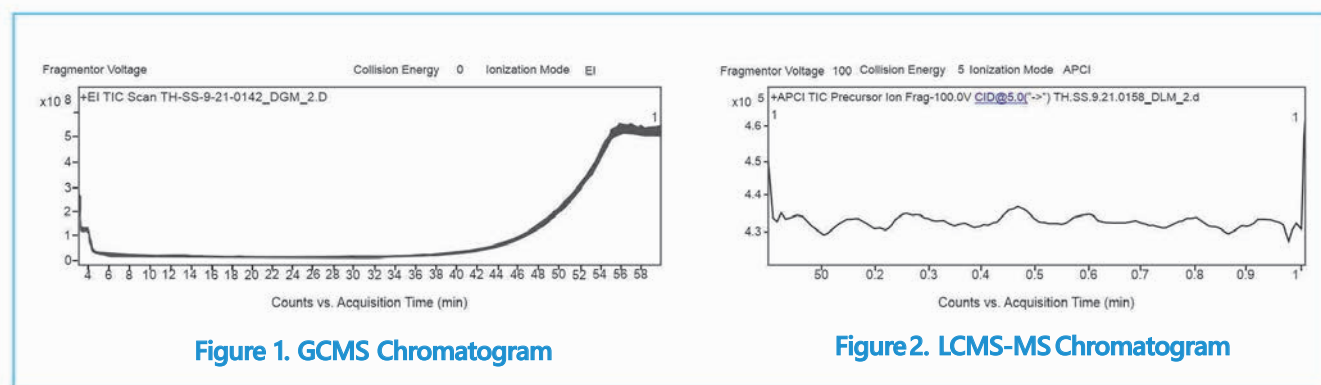

Figure 1. GCMS Chromatogram

Figure 2. LCMS-MS Chromatogram

NO EXTRANEOUS PEAK observed during chromatographic testing of vial & septa

2 ml HPLC TREATED VIALS & CLOSURES

Borosilicate USP Type I, ASTM Class A TREATED 33-Expansion glass vial with ultra pure certified septa



- Treated 33-Expansion Borosilicate Type I glass vial with **HIGH SILICON, LOWEST ALKALI** content
- Reduced the **RISK OF LEACHING** from glass vials
- **CHEMICALLY NERT** glass vial
- Leaf proof ultra pure certified **CHEMICALLY INERT** PTFE-Silicone septa



Glass vials with closures (COMBIPACK)

Product Code	Neck Dia	Septa Feature 1	Graduation with write on patch	Septa Feature 2	Pack Size	Case Lot	List Price Per Pack ₹
9mm Screw Top Clear Vials made from Borosilicate USP Type I, ASTM Class A Treated 33-Expansion glass with Closure Blue PP Cap Ultra Pure Certified PTFE-Silicone Septa							
VC02C409PBSUM1T	9mm	Pre Slit	NO	Bonded	100	10 X 100	6000.00
VC02C409PBSUM2T	9mm	Non Slit	YES	Bonded	100	10 X 100	6000.00

Extractables study of vials and septa using LCMS-MS and GCMS techniques

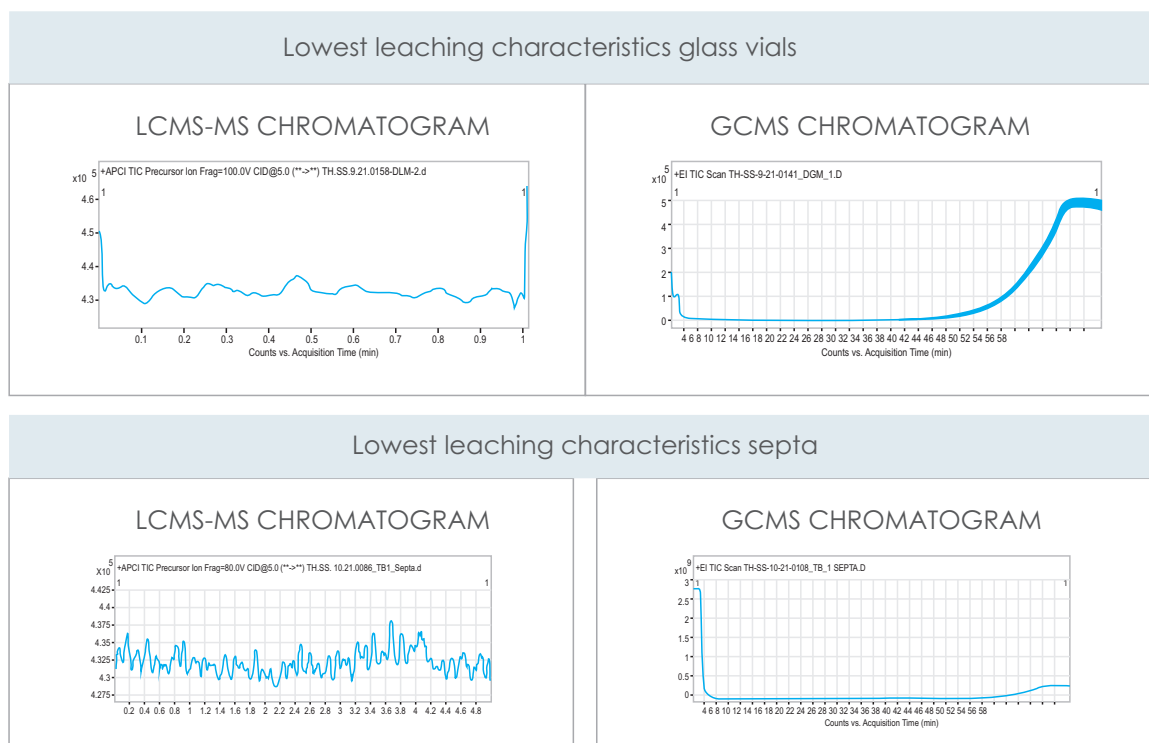

20 ml HEADSPACE GC VIALS & CLOSURES



Glass vials with closures (COMBPACK)

Product Code	Neck Dia	Septa Feature 1	Graduation with write on patch	Septa Feature 2	Pack Size	Case Lot	List Price Per Pack ₹
20mm Crimp Top Clear Vials made from Borosilicate USP Type I 49-Expansion glass with Closure Silver Aluminium Crimp PTFE-Silicone Septa							
VC20R120ASC041	20mm	Non Slit	YES	Assembled	100	5 X 100	7650.00
VC20F120ASC041	20mm	Non Slit	YES	Assembled	100	5 X 100	7650.00

Only Glass Vials

Clear Vials made from Borosilicate USP Type I glass

Product Code	Volume	Vial Colour	Graduation with write on patch	Neck Dia	Neck Type	Glass Detail	Special Feature 1	Pack Size	Case Lot	List Price Per Pack ₹
VO02C00900S000	2ml	Clear	NO	9mm	Screw	49 Expansion	–	100	10 X 100	1300.00
VO02A00900S000	2ml	Amber	NO	9mm	Screw	54 Expansion	–	100	10 X 100	1700.00
VO02C10900S000	2ml	Clear	YES	9mm	Screw	49 Expansion		100	10 X 100	1550.00
VO02A10900S000	2ml	Amber	YES	9mm	Screw	54 Expansion		100	10 X 100	2100.00
VO02C01100C000	2ml	Clear	NO	11mm	Crimp	49 Expansion		100	10 X 100	1150.00
VO02A01100C000	2ml	Amber	NO	11mm	Crimp	54 Expansion		100	10 X 100	1350.00
VO02C11100C000	2ml	Clear	YES	11mm	Crimp	49 Expansion		100	10 X 100	1250.00
VO02A11100C000	2ml	Amber	YES	11mm	Crimp	54 Expansion		100	10 X 100	1650.00
VO20R12000C000	20ml	Clear	YES	20mm	Crimp	49 Expansion	Round Bottom	100	5 X 100	3500.00
VO20F12000C000	20ml	Clear	YES	20mm	Crimp	49 Expansion	Flat Bottom	100	5 X 100	3500.00
VO06CF2000C000	6ml	Clear	NO	20mm	Crimp	49 Expansion	Flat Bottom	172	1 X 172	On request
VO06AF2000C000	6ml	Amber	NO	20mm	Crimp	54 Expansion	Flat Bottom	172	1 X 172	On request

*Only Closures are available on request. MOQ 500 PKTS

40 ml EPA / TOC COMBIPACK



Glass vials with closures (COMBIPACK)

Product Code	Neck Dia	Vial Colour	Septa Feature 1	Graduation with write on patch	Neck Dia	Special Feature 2	Pack Size	Case Lot	List Price Per Pack ₹
24mm Screw Top Clear Vials made from Borosilicate USP Type I with Closure White PP Cap Open Top Certified Bonded PTFE-Silicone Septa									
VC40C124POS111	24mm	Clear	Non Slit	YES	Silicone PTFE	Non Bonded	72	1 X 72	15400.00
VC40A124POS111	24mm	Amber	Non Slit	YES	Silicone PTFE	Non Bonded	72	1 X 72	On Request

SAMPLING & STORAGE VIALS



Product Code	Capacity ml	Approx Mouth ID in mm	Dimension O.D. x Length in mm	Case Lot (MOQ)	Price Per Piece ₹
9913003	3	10	16 x 36	1050	35.00
9913005	5	10	16 x 55	1050	40.00
9913006	10	16.5	24 x 50	600	65.00
9913007	15	16.5	24 x 58	600	70.00
9913008	20	16.5	24 x 70	600	85.00
9913010	30	16.5	24 x 95	600	100.00

* For details refer page no. 190



Borosil HPLC Inlet filters are designed to provide optimal performance and prevent contamination. These filters act as a shield, protecting the system and prolonging its lifespan.

- Made of high-quality 316 L sintered stainless steel
- Controlled porosity to selectively retain particles
- Excellent chemical and corrosion resistance
- Compatible with most HPLC systems & tubing sizes
- Bubble point tested to verify pore size and integrity for every lot of production

Universal Slip on 1/8



Push Fit PTFE Solvent Filter



Step Tube Fit Solvent Filter



Note: Use metal filters only with compatible solvents and avoid contact with corrosive chemicals.

Product Code	Description & Dimensions	Filter rating	Case Lot Units / Pack	List Price Per Pack ₹
SIFBSSSW1001	SS316L-SS 316-SLIP ON-1/8" solvent filter, single step, filter rating: 10 micron, size: 126425, MOC: SS 316L / SS 316L, 1/8" Slip-on	10 um	100	On Request
SIFBSSSS1002	SS316L-SS316 push fit PTFE, solvent filter, single step, filter rating 10 micron, size 126-425, MOC-SS316L, Push Fit PTFE	10 um	100	On Request
SIFBSSSU1003	SS316L-SS316 Step Tube Fit, solvent filter, single step, filter rating 10 micron, size 126-425, MOC-SS316L, Step Tube Fit	10 um	100	On Request

* 2micron Filter rating also available on request , MoQ exists

All filters are for intended application use only

Analytical Vials & Closures

Special Applications in Base Sensitive Drugs

- Low leached "GLASS" elements
- Chemically Inert
- High Transparency
- Mechanically stable
- High Silicon, Low Alkali
- 100% Dimensional Inspection
- Leak Proof Ultra Pure Certified PTFE-Silicone Septa
- Packed in Class 8 Clean Room
- Process Cleanliness Assurance
- Pre-slit septa for assay piercing
- Low VOC's Level Septa
- High Resealability

Made from Borosilicate USP Type I,
ASTM Class A 33-Expansion glass



“for Labs where
compliance matters”

Laboratory Accessories

For safer experiments



- TONGS
- CLAMPS
- CLAMP WITH BOSSHEADS
- BURETTE CLAMPS
- PLASTIC CLAMPS FOR JOINTS
- RETORT RING
- RETORT BASE
- ROD FOR RETORT BASE
- TEST TUBE STAND
- TEST TUBE HOLDER
- BURNER
- SPATULAS
- FORCEPS
- WIRE GAUGE
- TRIPOD

TONGS FOR BEAKERS & FLASKS

- Made of stainless steel
- Used to handle hot beakers & flasks
- Provided with silicon sleeves or in fibre glass yarn to resist direct flame

Product Code	Description	Size Inches	Case Lot No.	Price / Piece ₹
LATG8888B10	Beaker tong	10	6	430.00
LATG8888B12	Beaker tong	12	6	570.00
LATG8888F10	Flask tong	10	6	545.00
LATG8888F12	Flaks tong	12	6	675.00



TONGS FOR CRUCIBLE

- Made of Stainless Steel
- Used to handle hot crucibles

Product Code	Description	Size Inches	Case Lot No.	Price / Piece ₹
LACT8888006	Crucible tong with bow stainless steel	6	6	215.00
LACT8888008	Crucible tong with bow stainless steel	8	6	270.00
LACT8888010	Tong crucible, SS,	10	6	370.00
LACT8888012	Crucible tong with bow stainless steel	12	6	505.00



CLAMPS

- Available in Zinc & Aluminium diecasted
- It is coated with LEAD-FREE powder coating & fitted with brass screw which makes it totally RUST-FREE CLAMP
- Two & three finger clamp Jaws can be covered with PVC sleeves
- Two & four finger clamp has cork lined Jaws holds upto 90 mm articles
- It is provided with 8 mm diameter & 150 mm long Stainless Steel(Grade 201)rod

Product Code	Description	Case Lot No.	Price / Piece ₹
L AFC8888Z02	Two finger clamp, Zinc pressure die casted	10	430.00
L AFC8888AD3	Three finger clamp, Aluminum pressure die casted	10	505.00
L AFC8888ZD4	Four finger clamp, Zinc pressure die casted	10	430.00
L AFC8888AD4	Four finger clamp Aluminum pressure die casted	10	455.00





CLAMPS WITH BOSSHEAD

- Available in Zinc & Aluminium diecasted
- It is coated with LEAD-FREE powder coating & fitted with brass screw which makes it totally RUST-FREE CLAMP
- Two & three finger clamp Jaws can be covered with PVC sleeves
- Two & four finger clamp has cork lined Jaws holds upto 90 mm articles
- With adjustable bosshead attached clamp length can be vary, can be rotated 360° and locked at any angle

Product Code	Description	Case Lot No.	Price / Piece ₹
LAFC8888Z03	Two finger clamp (Zinc PDC) with adjustable bosshead	12	775.00
LAFC8888A03	Three finger clamp (Aluminium PDC) with adjustable bosshead	12	775.00
LAFC8888Z04	Four finger clamp (Zinc PDC) with adjustable bosshead	12	855.00
LAFC8888A04	Four finger clamp (Aluminium PDC) with adjustable bosshead	12	895.00



UNIVERSAL CLAMPS

- Single Burette / Test Tube Clamp made of stainless steel Jaws & Aluminium bosshead
- Round jaws are covered with PVC coating
- Opens from 15 mm to 45 mm in Diameter
- Clamps attaches to rods up to 13 mm in diameter. Threaded rod and wing nut adjust clamp angle and overall length from 13 cm to 15 cm

Product Code	Description	Case Lot No.	Price / Piece ₹
LABC8888SC1	Single Burette clamp, PVC coated jaws stainless steel	12	570.00
LABC8888S01	Single Burette clamp, PVC uncoated jaws, stainless steel	12	505.00

BURETTE CLAMPS

- Single / Double Burette clamp is made of Aluminium die casting
- Feature black PVC sleeves for firm gripping of burettes.
- This adjustable burette clamp is suitable for all burettes up to 100 ml which are held in place by the high pressure created by the springs yet allows easy operations without damaging the glassware

Product Code	Description	Case Lot No.	Price / Piece ₹
LABC8888B01	Single burette clamp, Aluminium PDC Fig. A	6	855.00
LABC8888A02	Double burette clamp, Aluminium PDC Fig. B	6	855.00
LABC8888AE1	Single burette clamp, Aluminium PDC (Eco.) Fig. C	6	430.00
LABC8888AE2	Double burette clamp, Aluminium PDC (Eco.) Fig. D	6	570.00

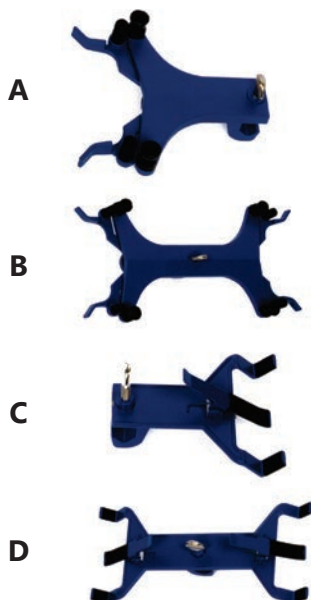

BOSSHEADS

- Bosshead made of Zinc & Aluminum pressure die casted
- It can hold a rod upto 16 mm diameter at 90° angle and Swivel bosshead rotate at 360° angle
- It is coated with LEAD-FREE powder coating & fitted with Nickel plated thumb screw

Product Code	Description	Case Lot No.	Price / Piece ₹
LABH8888RBL	Regular bosshead Zinc PDC Fig. A	12	215.00
LABH8888OBL	Round bosshead Zinc PDC Fig. B	12	270.00
LABH8888JBL	Jumbo bosshead Aluminum PDC Fig. C	12	570.00
LABH8888SBL	Swivel bosshead Zinc PDC Fig. D	12	380.00

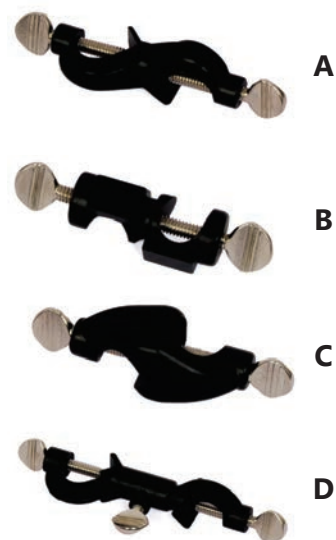

RETORT RING

- Strong circular mild steel ring with 6 mm diameter stem
- Open bosshead fitted with thumb screw to accept rods from 8 mm to 15 mm diameter

Product Code	Description	Size in Inches	Case Lot No.	Price / Piece ₹
LARR8888003	Retort Ring with bosshead	3	6	350.00
LARR8888004	Retort Ring with bosshead	4	6	445.00



RETORT BASE

- Superior Heavy duty steel alloy stand with rubber lining on a shorter side gives extra stability
- With lead-free powder coating

Product Code	Description	Size Inches	Case Lot No.	Price / Piece ₹
LARB8888H06	Retort base, Heavy	6" x 4"	6	775.00
LARB8888H08	Retort base, Heavy	8" x 5"	6	925.00
LARB8888H10	Retort base, Heavy	10" x 6"	6	1560.00



ROD FOR RETORT BASE

- With stainless steel Grade 201

Product Code	Description	Approx O.D. x Height mm	Case Lot No.	Price / Piece ₹
LARS8888500	Retort Rod (SS Grade 201)	12 x 500	2	545.00
LARS8888600	Retort Rod (SS Grade 201)	12 x 600	2	660.00
LARS8888750	Retort Rod (SS Grade 201)	12 x 750	2	755.00





TEST TUBE STAND

- It is made of Aluminum sheet, Z type, new design, single piece fabrication
- One row of holes of 30 mm diameter, the second row of holes of 25 mm diameter and third row of hole of 16 mm diameter
- This aluminium Z shape design is Coated with lead free powder coating make it corrosion resistant

Product Code	Description	Case Lot No.	Price / Piece ₹
LATS8888H19	Z' Shape Test Tube Stand, Aluminum, 19 hole assorted	6	570.00
LATS8888H25	'Z' Shape Test tube stand, 25 hole for 16mm tube	6	570.00



TEST TUBE HOLDER

- A pair of spring strip of hard rolled stainless steel, mounted in wooden handle in cross-scissor shape, and accepts tubes of diameter 12-43 mm.
- Overall length about 225mm

Product Code	Description	Case Lot No.	Price / Piece ₹
LATH8888000	Test tube holder, cross pattern, Stainless steel	24	245.00



BURNERS

- Bunsen Burner 13mm/11mm ideal for use with natural gas and L.P.G.
- Nickel-plated brass burner tube with Rotatable air regulator
- Enamelled Zinc pressure die casted base
- Base diameter 80 mm



Product Code	Description	Case Lot No.	Price / Piece ₹
LABR8888Z11	Bunsen burner, Zinc PDC base with 11 mm brass pipe for L.P.G. Fig. A	2	1070.00
LABR8888Z13	Bunsen burner, Zinc PDC base with 13 mm brass pipe for L.P.G. Fig. B	2	1070.00
LABR8888013	Burner, sheet metal base with 13 mm pipe, for L.P.G. Fig. C	2	855.00

SPATULAS

- Made of stainless steel grade 202
- Spatulas are used for measuring solids moving objects and scraping material out of beakers

Product Code	Description	Size in Inches	Case Lot No.	Price / Piece ₹
LACS8888006	Chattaway Spatula	6	20	90.00
LACS8888008	Chattaway Spatula	8	20	100.00
LASL8888C08	Micro Chattaway Spatula	8	20	95.00
LASC8888M06	Micro Scoop	6	10	80.00
LASC8888SM6	Semi Micro Spatula	6	10	115.00
LASL8888075	Big Spoon Spatula	7.5	10	170.00
LASL8888009	Big Spoon Spatula	9	10	185.00
LASP8888B06	Both side flat	6	20	95.00
LASP8888B08	Both side flat	8	20	125.00
LASP8888004	One end flat and one end Spoon	4	50	75.00
LASP8888006	One end flat and one end Spoon	6	50	80.00
LASP8888008	One end flat and one end Spoon	8	50	115.00
LASP8888010	One end flat and one end Spoon	10	50	175.00
LASP8888012	One end flat and one end Spoon	12	50	205.00
LASO8888W04	Ointment Spatula	4	10	215.00
LASO8888W06	Ointment Spatula Wooden Handle	6	10	235.00
LATG8888S06	Ointment Spatula Forged Stainless Steel	6	10	465.00
LASL8888P06	Pointer Spatula	6	10	125.00
LASC8888165	165 mm Scoop	6.5	10	115.00
LASL8888510	Big Spoon Spatula	10	10	325.00

* For products listed on the above table use HSN code 90189022

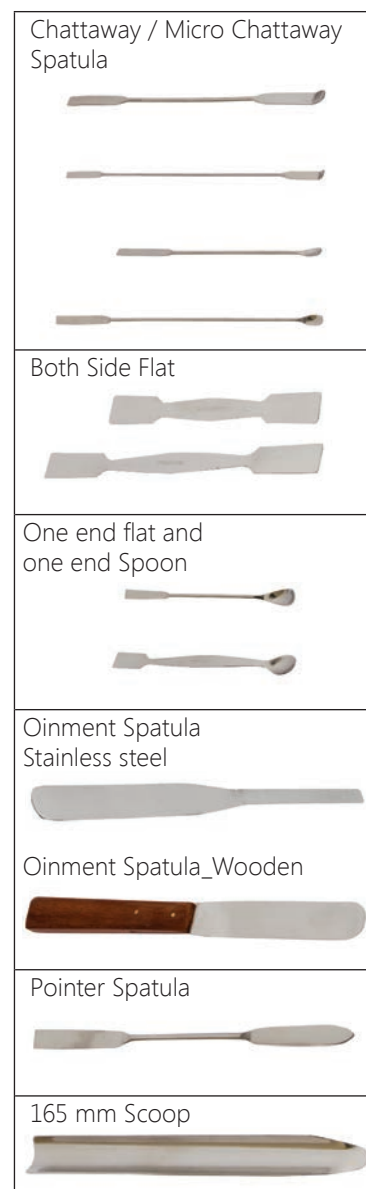



FORCEPS POINTED

Product Code	Description	Case Lot No.	Price / Piece ₹
LAFP8888004	Forceps, Pointed dissecting, 4"	10	130.00
LAFP8888005	Forceps, Pointed dissecting, 5"	10	180.00
LAFP8888006	Forceps, Pointed dissecting, 6"	10	215.00



FORCEPS PTFE POINTED

Product Code	Description	Case Lot No.	Price / Piece ₹
LAFPP8888004	Forceps, PTFE, Pointed end, 4"	10	1860.00
LAFPP8888006	Forceps, PTFE, Pointed end, 6"	10	2400.00



FORCEPS BLUNT DISSECTING

Product Code	Description	Case Lot No.	Price / Piece ₹
LAFB8888005	Forceps, Blunt dissecting, 5"	10	195.00
LAFB8888006	Forceps, Blunt dissecting, 6"	10	205.00
LAFB8888008	Forceps, Blunt dissecting, 8"	10	285.00



FORCEPS PTFE BLUNT

Product Code	Description	Case Lot No.	Price / Piece ₹
LAFBP8888004	Forceps, PTFE, Blunt end, 4"	10	1860.00
LAFBP8888006	Forceps, PTFE, Blunt end, 6"	10	2400.00

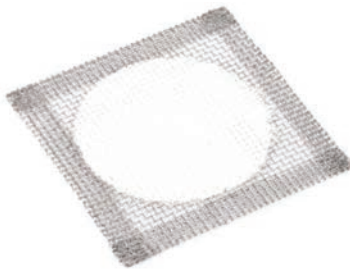

WIRE GAUGE

Product Code	Description	Case Lot No.	Price / Piece ₹
LAWG8888C05	Wire Gauge with Ceramic center 5" x 5"	10	125.00
LAWG8888C06	Wire Gauge with Ceramic center 6" x 6"	10	160.00



TRIANGULAR TRIPOD

Product Code	Description	Case Lot No.	Price / Piece ₹
LATT8888200	Triangular Tripod, SS, 200 x 125 mm	2	750.00

Laboratory Accessories

For safer experiments

Tongs



Clamp with PVC Coated Prong



Clamp



Clamp with Bosshead



Burette Clamp



Boss Head



Retort Ring & Test Tube Holder



Retort Base



Rod For Retort Base



Z Shape Test Tube Stand



Burner



Spatula



BOROSIL[®] Scientific Laboratory Filter Media

for Accurate Analysis and Consistent Results



- QUALITATIVE FILTER PAPERS
- ASHLESS QUANTITATIVE FILTER PAPERS
- HARDENED ASHLESS FILTER PAPERS
- GLASS FIBRE FILTER PAPERS
- CELLULOSE AND GLASS FIBRE THIMBLES

Borosil Filter Papers are made in collaboration with Hahnemühle - the pioneers in speciality papers since 1883!

The papers contain upto 98% alpha cellulose, the most stable form of cellulose in paper pulp, hence making the papers highly stable and durable. To ensure batch to batch uniformity and consistency in filtering performance, no recycled materials are used in the manufacturing processes. Very low ash content (Lowest value 0.004%) aid the laboratory professionals in accurate quantitative analysis with minimal errors. Made in Germany, the manufacturing processes and product specifications are compliant to the stringent European QC standards, guaranteeing the users finest quality filter papers.



BOROSIL[®] Scientific Laboratory Filter Media

Qualitative Filter Papers

Highly pure filter paper
recommended for qualitative analysis in laboratories.



Qualitative Filter Papers

High Purity Qualitative filter papers for routine laboratory filtration

- Filter papers for precise identification of materials and for sample preparation prior to sensitive detection method
- Made of refined cotton linters and cellulose
- Filter papers having >98% alpha cellulose, thereby ensuring highest stability and higher durability

Applications

- Recommended for precise identification of materials and for sample preparation prior to sensitive detection methods.
- Particle separation in Juices, Wine and other beverages production
- Qualitative analysis of milk and milk products.
- Sample preparation for water analysis
- Qualitative analysis of soil, fertilizer, animal feed

Technical Data

Grade	Sample	Speed	Retention rate [μm]	Filtration Herzberg (s)	Thickness (mm)	Weight [g/m^2]
B59501	Medium fine precipitates	Medium fast, thin	4 – 7	160	0.15	68
B59702	Medium-fine, crystalline precipitates	Medium fast	4 – 7	155	0.18	85
B59303	Fine precipitates	Medium slow	2 – 5	450	0.17	84
B60404	Coarse precipitates	Fast	12 – 25	50	0.19	79

* Approximate values,

** Measured with 100mm water column instead of 50 mm

APPLICATIONS



Agriculture



Food



Chemicals

and many more...

Ordering Info

Filter Paper circles

Product code	Size (dia in mm)	Pack size	List Price Price / Pack ₹
Grade B59501			
FPB595010070	70	100	1315.00
FPB595010090	90	100	1130.00
FPB595010110	110	100	1235.00
FPB595010125	125	100	1410.00
FPB595010150	150	100	1645.00
FPB595010185	185	100	2460.00
FPB595010240	240	100	5135.00
Grade B59702			
FPB597020070	70	100	1415.00
FPB597020090	90	100	1365.00
FPB597020110	110	100	1585.00
FPB597020125	125	100	1665.00
FPB597020150	150	100	2460.00
Grade B59303			
FPB593030070	70	100	2075.00
FPB593030090	90	100	2265.00
FPB593030110	110	100	2180.00
FPB593030125	125	100	3065.00
FPB593030150	150	100	3195.00
Grade B60404			
FPB604040047	47	100	1145.00
FPB604040055	55	100	1215.00
FPB604040070	70	100	1215.00
FPB604040090	90	100	1320.00
FPB604040110	110	100	1640.00
FPB604040125	125	100	1835.00
FPB604040150	150	100	2510.00
FPB604040185	185	100	3635.00
FPB604040240	240	100	6435.00
FPB604040320	320	100	10355.00

HSN Code 48232000

FILTER PAPER SHEETS

Product code	Size of sheets (in cm)	Pack size	List Price Price / Pack ₹
FPB595014657	46*57	100	13200.00
FPB597024657	46*57	100	21860.00
FPB593034657	46*57	100	39745.00
FPB604044657	46*57	100	27320.00

HSN Code 48054000

The comprehensive set-up

for your critical Laboratory Filtration Applications.

A perfect combination of BOROSIL Conical Flasks,
Glass Funnels and Filter Papers,

ensuring the users accurate results ALWAYS!



Choose through a range of Conical Flasks and Funnels suiting your applications

For more details please refer page no. 151 for Funnels and 108-109 for Conical Flasks

BOROSIL[®] Scientific Laboratory Filter Media

Ashless Quantitative Filter Papers

Ashless filters (avg ash content 0.004 %) for quantitative analysis, routine gravimetric tests and sample preparation for instrumental analysis.



Quantitative Filter Papers

Ashless quantitative filter papers for precise gravimetric tests, quantitative analysis of elements and sample preparation for instrumental analysis.

- Lowest ash content - 0.004%
- Made of refined cotton linters and cellulose
- Free of minerals and metallic ions, hence ideal for the detection of metallic ions
- Filter papers having >98% alpha cellulose, thereby ensuring highest stability and higher durability

Applications

- Determination and quantification of elements in soil, fertilizer, animal etc
- Gravimetric analysis in food products like milk and milk products, sugar, meat and meat products
- Quantitative analysis of elements in chemicals, pharmaceuticals, cement industry, food products etc
- Analysis of oil for its components
- Water analysis

Technical Data

Grade	Sample	Speed	Retention rate* [μm]	Filtration Herzberg (s)	Thickness (mm)	Weight [g/m^2]	Avg ash content
B58940	Fine crystalline precipitates	Medium	2-4	450	0.17	84	0.004%
B58941	Coarse and gelatinous precipitates	Fast	12-25	50	0.19	79	0.004%
B58942	Very fine crystalline precipitates	Slow	<2	750**	0.16	84	0.004%
B58943	Coarse precipitates	Medium Fast	4-12	140	0.18	85	0.004%
B58944	Fine crystalline precipitates	Slow thin	2	900	0.15	74	0.004%

* Approximate values,

** Measured with 100mm water column instead of 50 mm

● APPLICATIONS ●



Cement



Chemicals



Food

and many more...

Ordering Info

Filter Paper circles

Product code	Size (dia in mm)	Pack size	List Price Price / Pack ₹
Grade B58940			
FPB589400070	70	100	2290.00
FPB589400090	90	100	2860.00
FPB589400110	110	100	3420.00
FPB589400125	125	100	4285.00
FPB589400150	150	100	5500.00
FPB589400185	185	100	9110.00
FPB589400240	240	100	18340.00
Grade B58941			
FPB589410070	70	100	2355.00
FPB589410090	90	100	2985.00
FPB589410110	110	100	4010.00
FPB589410125	125	100	4560.00
FPB589410150	150	100	5920.00
FPB589410185	185	100	8585.00
Grade B58942			
FPB589420055	55	100	1880.00
FPB589420070	70	100	2355.00
FPB589420090	90	100	2860.00
FPB589420110	110	100	3605.00
FPB589420125	125	100	4285.00
FPB589420150	150	100	5500.00
Grade B58943			
FPB589430012	12.7	1000	4500.00
FPB589430125	125	100	4245.00
Grade B58944			
FPB589440090	90	100	3275.00
FPB589440110	110	100	3885.00
FPB589440125	125	100	4395.00
FPB589440150	150	100	7480.00
FPB589440185	185	100	10670.00

HSN Code 48232000

FILTER PAPER SHEETS

Product code	Size of sheets (in cm)	Pack size	List Price Price / Pack ₹
FPB589404657	46*57	100	58165.00
FPB589414657	46*57	100	54880.00
FPB589424657	46*57	100	53160.00

HSN Code 48054000

Did you know that around 90% of the errors in experiments are due to inaccurate chemical measurements?

It's time to take your experiments to the next level !

Laboratory Bottle Top Dispensers

are designed to measure reagents with **precision** and **accuracy** along with its exceptional chemical resistance.



Without recirculation

With recirculation

BOROSIL[®] Scientific Laboratory Filter Media

Hardened Ashless Filter Papers for quantitative analysis :

Hardened ashless filters (ash content approx. 0.003%), especially recommended for filtration applications requiring vacuum and pressure filtration, and for the use of acidic and alkaline solutions.



HARDENED ASHLESS FILTER PAPERS

Hardened ashless quantitative filter papers for quantitative and gravimetric analysis requiring high pressure or aggressive chemicals

- Avg ash content 0.003%
- Very high wet strength; hence easy to scrap off or wash off precipitates
- Hardened by small quantities of nitrogen-containing resin, which does not introduce significant impurities into the filtrate
- High resistance to aggressive chemical components, like sulphuric and nitric acids (up to 40 % at 50 ° Celsius) and alkalis (up to 10 % at 20 ° Celsius)
- Made of super-refined cotton linters and cellulose with alpha cellulose content more than 98%, hence higher stability and higher durability

Applications

- Gravimetric determination of metals in acidic/alkaline solutions.
- Quality control of chemicals
- Gravimetric analysis in oil refinery
- For analytical applications, routine quantitative and /or gravimetric procedures

Technical Data

Grade	Sample	Speed	Retention rate* [μm]	Filtration Herzberg (s)	Thickness	Weight [g/m^2]	Avg ash content
B15540	Fine crystalline precipitates	Medium	4-12	170	0.16	90	0.003%
B15541	Coarse crystalline precipitates	Fast	12-25	50	0.17	88	0.003%
B15542	Very fine crystalline precipitates	Slow	≤ 2	600**	0.14	90	0.003%

* Approximate values,

** Measured with 100mm water column instead of 50 mm

FILTER CIRCLES

Ordering Info

Product Codes	Size (dia in mm)	Pack size	List Price Price / Pack ₹
Grade B15540			
FPB155400125	125	100	5610.00
FPB155400150	150	100	8130.00
Grade B15541			
FPB155410125	125	100	5050.00
Grade 15542			
FPB155420125	125	100	5900.00
FPB155420150	150	100	8855.00

HSN Code 48232000



BOROSIL[®] Scientific Laboratory Filter Media

Glass Fiber Filter Papers

100% micro borosilicate glass fibres for specific applications
in environmental analysis



Glass Fibre Filters

Made of 100% micro-borosilicate glass fibres, these filters are recommended for air and water pollution analysis.

- Chemically stable in acidic solutions (except hydrofluoric acid) and alkaline solutions in moderate concentrations
- Extremely low metal content
- Maintains its properties up to 500°C
- High flow speed and high permeability to air

Applications

- Ambient air monitoring
- Determination of suspended particles (SPM and TSP) in air
- Monitoring of anthropogenic atmospheric emissions
- Gravimetric analyses of organic and inorganic contaminants in water and waste water

Technical Data

Type	Air permeability* (Resistance ** mbar) [L/m ² s]	Retention rate % NaCl-particle size <1 µm***	Filtration Gurley [s]	Weight [g/m ²]	Thickness [mm]	Max T [°C]	Retention range [µm]
BGF50A	25	99.97	19	56	0.29	500	1-3
BGF52C	54	99.995	25	54	0.28	500	1-3

* as per DIN 53887

** Air resistance at 400cm³/s, A = 10cm²

*** Tested with NaCl particles size <1 µm, main fraction at 0.3 to 0.5 µm

Ordering information

Product Codes	Size	Pack size	List Price Price / Pack ₹
FPBGF50A0037	37mm diameter	100	3990.00
FPBGF50A0047	47mm diameter	100	4160.00
FPBGF50A203254	203*254mm sheet (8*10 inches)	100	27950.00
FPBGF52C0047	47mm diameter	100	4200.00
FPBGF52C0125	125mm diameter	100	14690.00

HSN Code 70197100

● APPLICATIONS ●



Air Testing



Water Testing

and many more...

BOROSIL[®] Scientific Laboratory Filter Media

Thimbles

Cellulose and Glass Fibre thimbles for accurate and consistent extraction applications.



THIMBLES

Cellulose and Glass fibre thimbles for extraction of components

- Extraction thimbles to be used in your regular soxhlet apparatus based applications
- Consistent, high porosity of thimbles ensuring a rapid flow rate
- Made of cellulose or glass fibre based on application

Applications- Cellulose thimbles

- Extraction of fatty, greasy materials in foodstuffs, paints, varnishes etc
- Extraction of active agents from pharmaceuticals and plastic softening agents
- Analysis of pesticide waste, polyaromatic carbohydrates and dioxins in foodstuffs.
- Determination of oil content in oil-bearing seeds

Applications- Glass Fibre thimbles

- Extraction of solvents which are incompatible with cellulose fibres
- Gravimetric collection of dust particles or aerosols from hot air and gas flows
- Extraction during special biochemical analysis

Technical Data

Product	Material	Wall Thickness (mm)	Weight (gsm)	Air Permeability (L/m ² sec)
Cellulose Thimble	100% cellulose without binder	1.6	2.7	25
Glass Fibre Thimble	100% Micro-glass fibre without binder	1.3	3	15

Ordering information

Product Codes	Description	Size (Inner dia x height)	HSN Code	Pack size	List Price Price / Pack ₹
FPBCTH01990	BCTH 19x90mm Cellulose Thimbles	19x90	48237090	25	11150.00
FPBCTH022080	BCTH 22x80mm Cellulose Thimbles	22x80	48237090	25	11590.00
FPBCTH022100	BCTH 22x100mm Cellulose Thimbles	22x100	48237090	25	12000.00
FPBCTH025080	BCTH 25x80mm Cellulose Thimbles	25x80	48237090	25	11455.00
FPBCTH025100	BCTH 25x100mm Cellulose Thimbles	25x100	48237090	25	11455.00
FPBCTH028100	BCTH 28x100mm Cellulose Thimbles	28x100	48237090	25	11510.00
FPBCTH033080	BCTH 33x80mm Cellulose Thimbles	33x80	48237090	25	13600.00
FPBCTH033100	BCTH 33x100mm Cellulose Thimbles	33x100	48237090	25	13625.00
FPBGFTH01990	BGFTH 19*90mm Glass Fibre Thimbles	19x90	70197100	25	18995.00

Laboratory Equipment

LabQuest by Borosil are products that meet Borosil's high standards of reliability, performance and value.

All products are backed by Borosil's robust service and after sale support.

Manufacturers of Laboratory Equipment

SMART

RUGGED

PRACTICAL



- KJELDHAL SYSTEM
- COD DIGESTERS
- FAT DETERMINATION APPARATUS
- UV VISIBLE SPECTROPHOTOMETER
- WATER DISTILLATION UNITS
- CONTROLLED HEATING MANTLES
- STIRRERS
- CHILLER
- LABWARE DRYER
- DRY BATH

- VORTEX MIXERS
- CENTRIFUGE
- MICROPIPETTES
- SHAKERS
- VACCUM PUMP
- OVERHEAD STIRRERS
- BOTTLE TOP DISPENSERS
- DIGITAL BURETTE



Kjeldahl

Magnus Digesters

Automatic Kjeldahl Digestion unit with 8 / 12 / 20 position aluminium heating block that offers excellent thermal homogeneity and stability.



Technical Data & Ordering Information

Model Name	KBD083	KBD123	KBD203
Type	Block Digester	Block Digester	Block Digester
No. of positions	8	12	20
Tube capacity (ml)	250 / 400		
Temperature Range	Ambient to 470°C		
Timer Range	1-1200 mins		
Temperature Precision	±1°C		
Ramp and Hold	upto 4		
Presets	upto 50, editable		
Auto scrubber ON/OFF	Yes		
PID control	Yes		
Autolift	Yes		
Auto OFF after achieving set time	Yes		
Temperature Calibration	Yes, single and two point		
PC & Printer Connectivity	Yes, upgradable		
Display	Graphical LCD		
Body	Stainless steel with control pannel of FRP		
Current Consumption	6A	8A	12A
Dimensions (W × D × H)	(416 × 554 × 595) mm		(410 × 585 × 735) mm
Power Consumption	1400W	2100W	2800W
HSN Code	84198990		
Ordering Code	BLFAKBD08300000000	BLFAKBD12300000000	BLFAKBD20300000000
Prices / Piece	On Request		

Kjeldahl

Oracle Digesters

Kjeldahl Digestion unit with 6 / 8 / 12 position aluminium heating block that offers excellent thermal homogeneity and stability.



Technical Data & Ordering Information

Model Name	KBD062	KBD082	KBD122
Type	Block Digester	Block Digester	Block Digester
No. of positions	6	8	12
Tube capacity (ml)	250/400		
Temperature Range	Ambient to 470°C		
Timer Range	1-1200 mins		
Temperature Precision	±1°C		
Ramp and Hold	upto 4		
Presets	upto 50, editable		
Auto scrubber ON/OFF	Yes		
PID control	Yes		
Autolift	No		
Auto OFF after achieving set time	Yes		
Temperature Calibration	Yes, single and two point		
PC & Printer Connectivity	Yes		
Display	Graphical LCD		
Body	Stainless steel with control pannel of FRP		
Current Consumption	6A	6A	8A
Dimensions (W × D × H)	(410 × 585 × 735) mm	(410 × 585 × 735) mm	416 × 554 × 595
Power Consumption	1400W	1600W	2100W
HSN Code	84198990		
Ordering Code	BLFAKBD06200000000	BLFAKBD08200000000	BLFAKBD12200000000
Prices / Piece	On Request		

Optional Accessories

Description	Ordering Code	Prices / Piece
Viton Rubber Tube - 10mm ID × 14mm OD – 1Mtr	BLA0VRT10D0014DBLK	3,520.00
Teflon Fume Cap ACCS (Case Lot – 01 No)	BLAAFUT100PTFE1651	1,850.00
KBD062 Fume Extractor	BLAAKBD06230000000	10,480.00
KBD080 Fume Extractor Glass ACCS	BLA0FUTKBD080D2510	12,570.00
KBD082 Fume Extractor	BLAAKBD08230000000	15,960.00
KBD083 Fume Extractor ACCS	BLAAKBD08330000000	16,920.00
KBD123 Fume Extractor ACCS	BLAAKBD12330000000	21,720.00
KBD200 Fume Extractor Glass ACCS	BLA0FUTKBD200D2510	14,790.00
KBD203 Fume Extractor ACCS	BLAAKBD20330000000	28,340.00
KBD062 Cooling Tray	BLAAKBD06170000000	6,660.00
KBD082 Cooling Tray ASM ACCS	BLAAKBD08250000000	7,030.00
KBD123 Cooling Tray ASM ACCS	BLAAKBD12350000000	8,880.00
KBD203 Cooling Tray ASM ACCS	BLAAKBD20350000000	11,090.00
KBD062 Test Tube Holder ACCS	BLAAKBD06220000000	6,960.00
KBD082 Test Tube Holder ACCS	BLAAKBD08220000000	12,080.00
KBD083 Test Tube Holder ACCS	BLAAKBD08320000000	14,200.00
KBD122 Test Tube Holder ACCS	BLAAKBD12200000000	16,880.00
KBD123 Test Tube Holder ACCS	BLAAKBD12320000000	18,800.00
KBD203 Test Tube Holder ACCS	BLAAKBD20320000000	21,200.00
250 ml Borosilicate Test Tube ASM (Case lot-5)	BLMATTB01041250000	10,560.00
400ml Borosilicate Test Tube ASM (Case lot-5)	BLAATTB01050400001	12,320.00
Quartz Test Tube 250ml ASM (Case lot-2)	BLGATTQ01041250000	9,280.00

Fume Scrubber

Safe, zero exposure & high capacity
fume scrubber for Kjeldahl digestion systems



Technical Data & Ordering Information

Model Name	KSC010	KSC020
Current	1A	1A
Pump delivery Rate	28 Ltr/Min	45 Ltr/Min
Dimensions (W × D × H)	(445 × 375 × 460) mm	
HSN Code	84198990	
Ordering Code	BLFAKSC01000000000	BLFAKSC02000000000
Prices / Piece	On Request	

Optional Accessories

Model Name	Ordering Code	Prices / Piece
Silicon Transt Tube - 8MMIDx10MMOD - 1Mtr	BLA0STT8D00012TRNP	200.00
Viton Rubber Tube - 10MMIDx14MMOD - 1Mtr	BLA0VRT10D0014DBLK	3,520.00
Clear Braided PVC Hose pipe ACSS	BLOPIPPVC0HOS00CB	1,110.00
2L Reagent bottle - 1500030 ASM	BLA0BGW10001500030	2,120.00
KSC 020 Condenser V2 ASM	BLAAFUTV2KSCCD2932	4,890.00
KSC 010 Condenser V3 ACSS	BLAAFUTV3KSCCD2932	4,140.00
KSC Carbon Bottle ASM	BLAACRB02020018000	2,640.00

Kjeldahl



Magnus Distillation System with Autotirator

Smart, efficient distillation systems for labs now available with Inbuilt Autotitration

Excellent features with high reliability and advance performance.



Technical Data & Ordering Information

Model Name	KDI060	Model Name	KDI060
Steam	Distilled water	Alkali	Boric Acid Addition
Residue drain	Automatic	Titration Type	pH base
Display	7" colored touch screen	Water Addition	Automatic
Tube Capacity (ml)	250 / 400ml	Distillation Residue Removal	Automatic
Steam power regulation (Adjustable)	10 to 100%	Titration Cleaning Vessel	Automatic
Minimum distillation time (mins)	5	Detection Limit	0.1ml
Reagent level sensor	Yes	Analysis time	upto 1min
Anytime alkali addition	Yes	Titration Residue Removal	Automatic
Tube error detection	Yes	Boric Acid Addition	Automatic
Door close sensor	Yes	Burette Resolution	0.03ml/drop
Process resume from stop	Yes	Power Supply	230V/50Hz
One point calibration alkali and distilled water pump	Yes	Current Consumption	10A
Two point calibration for acid pump	Yes	Power Consumption	1800 W
Real time monitoring of process parameter	Yes	Dimension (L x B x H) mm	(480 x 470 x 820) mm
SELV protection	Yes	HSN Code	84198990
Programs	40 preset, 10 user editable	Ordering code	BLFAKDI06000000000
PC Connectivity	Yes	Price / Piece	On Request
Nitrogen recovery	>99.5%		
Nitrogen reproducibility	0.01		
RSD	<1%		
LOD	1-200mg with of = 0.1mg of Nitrogen		

Kjeldahl

Magnus Distillation System

Smart, efficient distillation systems for labs. Excellent features with high reliability and advance performance.



Technical Data & Ordering Information

Model Name	KDI050
Steam addition	Automatic
Distilled water addition	Automatic
Alkali addition	Automatic
Boric acid addition	Automatic
Tube Drain	Automatic
Display	7" colored touch screen
Tube Capacity (ml)	250 / 400ml
Steam power (Adjustable)	10-100%
Minimum distillation time (mins)	5
Reagent level sensor	Yes
Anytime alkali addition	Yes
Tube error detection	Yes
Door close sensor	Yes
Process resume from stop	Yes
One point alkali and distilled water pump	Yes
Two point calibration for acid pump	Yes
Real time monitoring of process parameter	Yes
SELV protection	Yes
Programs	40 preset, 10 user editable
PC Connectivity	Yes
Nitrogen recovery	>99.5%
Nitrogen reproducibility	±1 %
RSD	<1%
LOD	1-200mg with of = 0.1mg of Nitrogen
Current Consumption	10A
Power consumption	1800 W
Dimension (L × B × H) mm	(480 × 470 × 820) mm
HSN Code	84198990
Ordering Code	BLFAKDI05000000000
Price / Piece	On Request

Kjeldahl

Oracle Distillation System

Smart, efficient distillation systems primarily for kjeldahl analysis with simple and reliable features.



Technical Data & Ordering Information

Model Name	KD1040
Steam addition	Automatic
Distilled water addition	Automatic
Alkali addition	Automatic
Boric acid addition	Automatic
Display	LCD
Tube Capacity (ml)	250 / 400ml
Steam power (Adjustable)	25%-100%
Minimum distillation time (mins)	5
Reagent level sensor	Yes
Anytime alkali addition	Yes
Tube error detection	Yes
Door close sensor	Yes
Process resume from stop	Yes
One point alkali and distilled water pump	Yes
Two point calibration for acid pump	Yes
Real time monitoring of process parameter	Yes
SELV protection	Yes
User Editable Programs	40 preset, 10 user editable
PC Connectivity	Yes
Nitrogen recovery	>99.5%
Nitrogen reproducibility	±1 %
RSD	<1%
LOD	1-200mg with of = 0.1mg of Nitrogen
Current Consumption	5.5A
Power consumption	1000 W
Dimension (L × B × H) mm	(650 × 350 × 725) mm
HSN Code	84198990
Ordering Code	BLFAKD10400000000
Price / Piece	On Request

Accessories

Magnus Kjeldahl Distillation / Oracle Kjeldahl Distillation

Optional Accessories

Description	Ordering Code	Prices / Piece
Silicon Transt Tube-8mmidx10mmod - 1mtr	BLA0STT8D00012TRNP	200.00
Clear Braided PVC Hose Pipe ACCS - 1Mtr	BLA0PIPPVC0HOS00CB	1,110.00
KDI PTFE Tube - 10mm OD × 08mm ID - 1Mtr	BLA0TUB000PTFE1008	3,700.00
KDI FLOW SWITCH ASM ACCS	BLAAKDI05010000001	3,160.00
KDI Drip Tray ASM	BLA0KDI000DRP0TRAY	1,260.00
Oven Mittes - KDI ASM	BLA0OVM000KDI00000	520.00
KDI PP Jerry Can ACCS	BLA0JCNPP00000005L	680.00



Complete Solution for Proximate Analysis

Our product line now encompasses a comprehensive range for proximate analysis, ranging from protein to moisture, fat, and fiber analysers

Moisture analyser provide a definitive solution for moisture testing, a utmost parameter required to be estimated by food & feed industries.

New and revamped **Protein, Fat & Fiber analysers** are compact models that save on time, reagent and increase sample throughput

These products have been meticulously crafted to provide results with unparalleled precision, accuracy, and reproducibility.

Kjeldahl

Classical Distillation Unit

Safe, simple, efficient distillation systems for labs



Technical Data & Ordering Information

Model Name	CKD015	CKD065
No. of positions	1	6
Flask Capacity	500 ml Kjeldahl Flask. Also compatible with 800 ml Kjeldahl Flask	
Energy mode	1-10	
Temperature regulators	1	6
Display	LED Display with time, safe temperature & process status	
Timer	1-999 Minutes	
Power consumption	150W	900W
Electrical regulation	0.65A	3.9A
HSN Code:	84198990	
Ordering Code	BLFACKD01500000000	BLFACKD06500000000
Prices / Piece	54,210.00	On Request

Accessories

Description	Ordering Code	Prices / Piece
Graham Condenser 200mm Jacket ACCS	BLA0BGW200KJDLGHM0	4,440.00
CLASSICAL KJELDHAL SPLASH HEAD-2429 ACCS	BLA0KSH24291926CKJ	2,120.00
CKD065 with Stand ASM (Entire assembly without glass parts)	BLAACKD06500000000	68,880.00
CKD015 with Stand ASM (Entire assembly without glass parts)	BLAHCKD01510000000	3,520.00

Note : All accessories are provided by default with the unit

Alcohol Distillation Unit with Chiller

- Smart way to analyse alcohol content in sample.
- Quick distillation saves time
- A chiller gives effective condensation and helps detect close to accurate alcohol content.



Technical Data & Ordering Information

Model Name	KDI040
Tube capacity (ml)	250 ml/ 400 ml
Steam addition	Automatic
Display	24 × 7 LCD
Cooling water flow rate sensor	Yes
Drip tray	Yes
Visual reagent level warning	Yes
Steam power	Adjustable
Steam output regulation	25-100%
Maximum distillation time (mins)	20 mins
Tube error detection	Yes
Door close sensor	Yes
Control button	Rotary push button
Dimensions (W × D × H)	(380 × 350 × 725) mm
Current consumption (A)	5.5 A
Power consumption (W)	1000W
Voltage	230- 50/ 60 Hz
HSN Code	84198990
Ordering Code	BLFAKDI04000000000
Prices / Piece	On Request

Technical Data & Ordering Info

Model Name	CHL010
Tank capacity	10 L
Tank size (L × W × D) mm	(325 × 265 × 200) mm
Cooling capacity	1000 W
Pump flow rate	12.5 LPM
Display	LED
Temperature stability	± 1.0°C
Temperature range	-10 to ambient
HSN Code	84198990
Ordering Information	BLFRCHL01000000000
Prices / Piece	On Request

Fat Determination by Soxhlet Extraction

Delivering classical solutions with modernized approach for fat extraction



Technical Data & Ordering Information

Model Name	SOX012	SOX015	SOX062	SOX065
Positions	1	1	6	6
Flask Capacity (ml)	250	500	250	500
Extractor capacity (ml)	100	200	100	200
Display Timer	1-999 min			
Dimension (W × D × H) mm	200 × 300 × 800		1050 × 300 × 800	
Weight (Kgs)	7		15	
Power (W)	400 W		2400 W	
HSN Code	84198990			
Ordering Code	BLFRSOX 01200000000	BLFRSOX 01500000000	BLFRSOX 06200000000	BLFRSOX 06500000000
Price / Piece	On Request			

Accessories

Description	Ordering Code	Prices / Piece
SOX012 with Stand ASM (Entire assembly without glass parts)	BLAASOX01210000000	16,320.00
SOX015 with Stand ASM (Entire assembly without glass parts)	BLAASOX01510000000	17,280.00
SOX062 with Stand ASM (Entire assembly without glass parts)	BLAASOX06200000001	63,780.00
SOX065 with Stand ASM (Entire assembly without glass parts)	BLAASOX06500000001	73,280.00
SOXHLET 100 ML EXTRACTOR	BLA0SOXEXT10044327	5,000.00
SOXHLET 200ML EXTRACTOR	BLA0SOXEXT20048394	5,280.00
SOXHLET CONDENSER FOR 100ML EXT V2 ACCS	BLA0CON000SOX100V2	6,660.00
SOXHLET CONDENSER FOR 200ML EXT V2 ACCS	BLA0CON000SOX200V2	5,040.00

Rapid Fat Analyser



- Rapid fat extractor with benchmarking features of auto solvent Recovery, Boiling & Rinsing process
- Individual operating positions
- Up to 2 times faster than traditional method
- Water flow detection for condenser
- Smooth condenser lifting operation
- Easy to remove condenser for cleaning



Technical Data & Ordering Information

Model Name	FAS060
No of positions	6
Sample size	0.5 gm to 10 gm
Recovery of Solvent	80-90%
Limit of detection	0.1% to 100 %
Heating profile	Energy regulator 1 to 10
Display	7" touch screen
Water flow sensor	Yes
Beaker solvent capacity	150 ml
Condenser	Seal Viton (FKM)
Chiller water temp	10-15°C
Heater temp range	280°C
Recovery bottle capacity	2 liter
Flow cut off sensor	Yes
Vacuum pump flow rate	380 L/hr
Power supply	230 V 50 – 60 Hz
Current Consumption	5.2A
Power consumption	1200 W
Dimensions (L × B × H) mm	(840 × 430 × 600) mm
HS Code	84198990
Ordering code	BLFRFAS06000000000
Price / Piece	On Request

Technical Data & Ordering Information

Description	Ordering Code	Pack Size	Price/ pack
33 × 80 mm Cellulose Thimbles	FPBCTH6033080	6	4,350.00
Thimble holder	BLAMFAS06010000020	6	On Request
Beaker 55MM DIA ACCS	BLA0FAS060BKR55124	6	On Request
FAS060 RANDALL condenser ACCS	BLA0FAS060CON56326	1	On Request

Rapid Fiber Analyser

**NEW
PRODUCT**

- Fiber bag spacer method to increase throughput
- Automatic agitation using radial flow stirrer for maximum efficiency
- Non - Pressurized system for user safety
- Buzzer alert upon process completion
- Drop in coupling to ensure perfect head to base fit
- Compact design reducing bench space
- Performs Crude Fiber, ADF, ADL and NDF determinations
- Use a fat extral for to defat sample before fiber analysis



Technical Data & Ordering Information

Model Name	MFB008
No of positions	8
Sample size	0.5 - 3gm
Measuring Range	0.1 % - 100 %
Drop-in coupling	Yes
Fiber bag material	Nylon
Agitation	Automatic
Stirrer type	Radial flow stirrer
Beaker volume	3 L
Reagent required per process (acid & alkali)	1.5 liter
Power supply	200 - 240 V 50 - 60 Hz
Current Consumption	4A
Total Power consumption	750 Watts
Dimensions (LxBxH) mm	(235 × 370 × 644) mm
HS Code	84198990
Ordering code	BLFAMFB00800000000
Price / Piece	On Request

Accessories

Description	Ordering Code	Pack Size	Price/ pack
MFB008 Fiber Filter Bag ACCS	BLAAMFB008CRC00000	50	On Request
MFB008 50ml CRUCIBLE WITH CRUCIBLE LID ACCS	BLAAMFB008CRULIDAC	1	On Request
MFB008 CRUCIBLE TRAY ACCS	BLAAMFB008CRCTRYAC	1	On Request
MFB008 CRUC TRAY WITH CRUCIBLE &LID ACCS	BLAAMFB008CRCLIDAC	1	On Request
MFB008 GLASS SPACER ACCS	BLAAMFB00810000004	2	On Request
MFB008 INSERT RACK ACCS	BLARMFB00811000000	1	On Request

Moisture Analyser **NEW PRODUCT**

- Ultra-fast and uniform halogen heating
- Increased capacity of 60gm
- Mono-tech sensor for accurate results
- User Friendly Interface
- Different Drying Modes for variety of application



Technical Data & Ordering Information

Model Name	MB63
Readability	0.001
Repeatability (Sd) for initial sample wt. = 2gm	0.10%
Repeatability (Sd) for initial sample wt. = 10gm	0.03%
Units of measurements	%M, %D, %R (Ratio), Gm/Lt, %M Atro, %D Atro
Data Storage	Last 1000 moisture determination results
Max. sample weight	60gm
Minimum sample weight	0.2gm
Readability	0.001gm
Technology	Halogen
Temperature Range	30 - 175 °C (Optional 250 °C)
Temperature Increment	1°C
Switch off criteria	Auto manual, User Def weight /Time, User Def % Unit/Time, Intelligent
Auto Method development	Intelligent
Method memory	40
Batch Memory	100
Method designation	Alpha numeric
Serial number	Yes
Display	Graphical display with LED backlight
Data interface	Rs.232 C bidirectional, USB Ethernet
Print	GLP/GMP compliant, User configurable
Test	Weighing and heater
Weight in assist	Yes
Weight	5Kg
Power Supply	230V/50Hz or 115V/60Hz
Power Consumption	415 W
Current Consumption	1.8A
Dimension (W × D × H) mm	(211 × 342 × 178) mm
HS Code	90160010
Ordering Code	100MB630000000
Price / Piece	On Request

Accessories

Description	Ordering Code	Pack Size	Price/ pack
Aluminium Dish	100MB63DAD0000	40	9,000
Glass Fiber Filter- 47mm	FPBGF50A0047	100	4,160
Calibration Weights	100MB63CTWF100	1	37,000
Temperature Calibration Kit	100MB63TCK0000	1	22,000

Quanta- UV Visible Spectrophotometer

NEW
PRODUCT

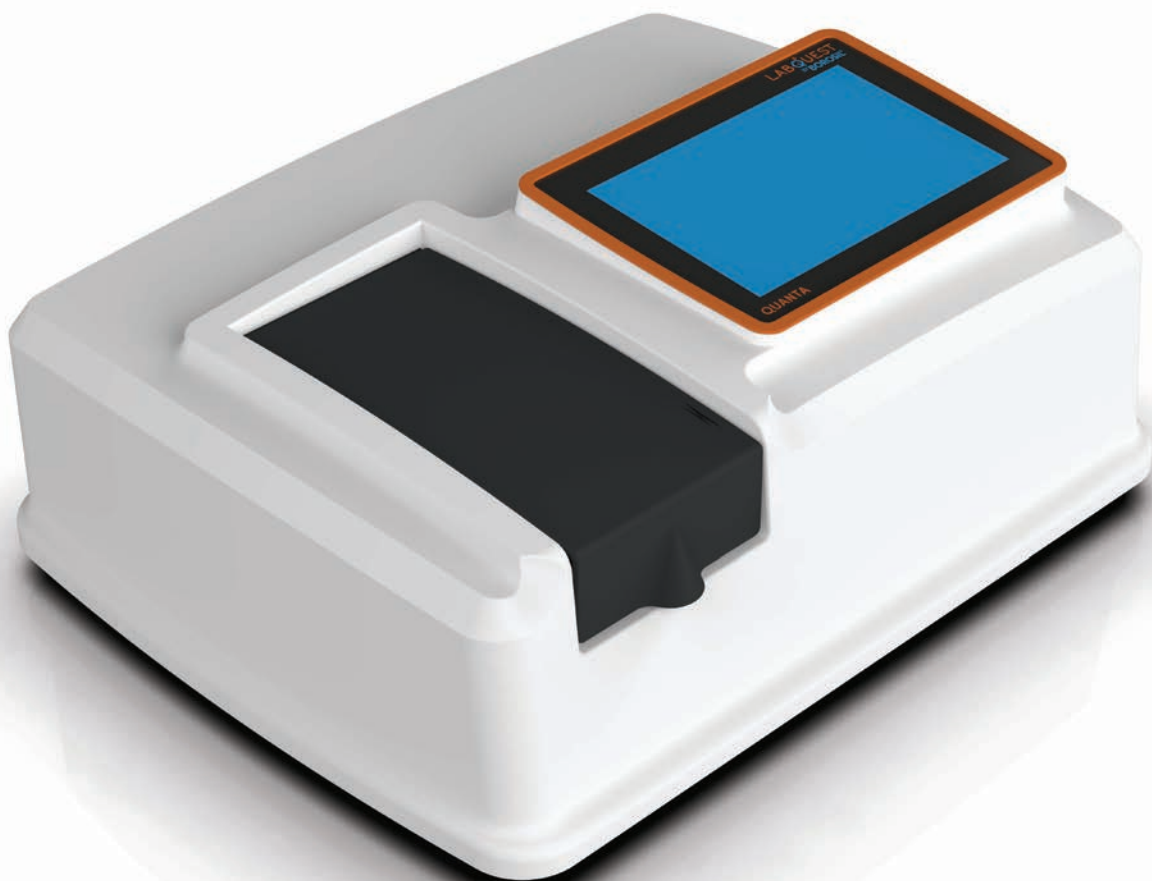

* Image used for representation purpose only

- Configurable scan wavelength from 0.1nm to 5nm for accurate/faster analysis
- Pre-aligned opcs allow easy lamp change
- Large sample compartment to accommodate various path length cuvettes
- Automatic changeover of wavelength with configurable wavelength
- Blazed holographic grang in Czerny-Turner mounting
- Ethernet, Wi-Fi, Bluetooth, USB Mass Storage, Email, USB through PC
- Optional Accessories of Microcell, Long path 20, 40, 50, 100 mm cell, Circular Test Tube holder, Peler based constant temperature attachment controlled via software, Variable Slit setup, Automatic Multi Cell Changer
- Optional CFR21 part 11 analysis software with server-client architecture

Technical Data & Ordering Information

Parameter	Quanta Pro	Quanta Promax
Colored Touch Screen Display	10inch	10inch
Photometric system	True Double beam Optics	True Double beam Optics
UV/Vis Bandwidth Type	Fixed	Variable
Wavelength range	190 to 1100 nm	180 to 1100 nm
UV/Vis Bandwidth Increments (nm)	1 nm	0.1 nm to 5.0 nm
Wavelength Setting	0.1nm increments	0.1nm increments
Wavelength Display Resolution (nm)	0.1nm	0.1nm
Measuring Modes	ABS, %T, CONC with custom K-Factor and multiple standards	ABS, %T, CONC with custom K-Factor and multiple standards
Wavelength Accuracy	+/-0.05nm @ 656.1nm +/-0.1nm entire range	+/-0.1nm @ 656.1nm +/-0.1nm entire range
Wavelength Repeatability	+/-0.1nm	+/-0.1nm
Wavelength Slew rate	About 29000 nm/min	About 6000 nm/min
Wavelength Scan speed (nm/min)	3600 to 2nm/min for survey of 29000nm/min	4000 to 2nm/min
Lamp interchange wavelength	Automatic changeover of wavelength with configurable wavelength.	Automatic changeover of wavelength with configurable wavelength.
Stray light	Less than 0.02% at 220nm (NaI) Less than 0.02% at 340nm (NaNO ₂) Less than 0.5% at 198nm (KCl)	Less than 0.02% at 220nm (NaI) Less than 0.02% at 340nm (NaNO ₂) Less than 1.0% at 198nm (KCl)
Photometric readability range (Abs)	Absorbance: -4.0 to 4.0 Abs Transmittance : 0% to 400%	Absorbance: -4.0 to 4.0 Abs Transmittance : 0% to 400%
Photometric accuracy	+/-0.002 Abs at 0.5 Abs +/-0.004 Abs at 1.0 Abs +/-0.006 Abs at 2.0 Abs	+/-0.002 Abs at 0.8 Abs +/-0.004 Abs at 1.2 Abs +/-0.006 Abs at 2.1 Abs
Photometric repeatability	Less than +/-0.001 Abs at 0.5 Abs Less than +/-0.001 Abs at 1 Abs Less than +/-0.003 Abs at 2 Abs	Less than +/-0.001 Abs at 0.8 Abs Less than +/-0.001 Abs at 1.2 Abs Less than +/-0.003 Abs at 2.1 Abs
Baseline stability	Less than 0.0002 Abs/Hr @700 nm (one hour after light source ON)	Less than 0.0002 Abs/Hr @700 nm (one hour after light source ON)
Baseline flatness (±A)	Less than +/-0.0005 Abs (avg. points) (1100 to 190nm, one hour after light source switched ON)	Less than +/-0.0005 Abs (avg. points) (1100 to 190nm, one hour after light source switched ON)
Noise level	Less than 0.00003 Abs (700nm)	Less than 0.00005 Abs (700nm)
Light source	Plug- in pre-aligned Halogen lamp and Deuterium lamp or Xenon Lamp	Plug- in pre-aligned Tungsten Halogen lamp and UV Deuterium lamp
Monochromator	Blazed holographic grating 1200 lines/mm in Czerny Turner mounting	Blazed concave holographic grating 1200 lines/mm in Czerny Turner mounting
Detector	Dual Silicon photodiode	Dual matched silicon photodiode
Environmental requirements	Temperature 15 to 38 Humidity 30% to 80%	Temperature 15 to 38 Humidity 30% to 80%
Output device	Inbuilt with desktop OS with high resolution 10inch touch screen LCD	Inbuilt with desktop OS with high resolution 10inch touch screen LCD
Software	Scanalyser software (Microsoft windows 7 and above) CFR 21 compliance	Scanalyser software (Microsoft windows 7 and above) CFR 21 compliance
Validation	Automatic measurement and pass/ fail evaluation and printing of results	Automatic measurement and pass/ fail evaluation and printing of results
Connectivity	LAN/ Ethernet/WiFi/Bluetooth	LAN/ Ethernet/WiFi/Bluetooth
Sample compartment internal dimensions (W × D × H) mm	115 × 250 × 90 Distance between light beams :80mm	115 × 250 × 90 Distance between light beams: 80mm
Dimensions (L × B × H) mm	560 × 430 × 195	556 × 486 × 236
Power Supply	230V/50Hz	230V/50Hz
Ordering Code	100UVFIX000000	100UVVAR000000
HS Code	90273020	90273020
Weight	22Kg	24Kg
Prices / Piece	On Request	On Request

Accessories

Description	Ordering Code	Price
Variable Slit	100UVVS0000000	66667.00
8 Cell round Auto Sampler	100UV08RAS0000	38096.00
7 Cell Linear Auto Sampler	100UV07LAS0000	34286.00
Peliter based Temperature controlled Single Cell 4 (Sample) 15-65c	100UV04PTC0000	66667.00
Peliter based Temperature controlled Single Cell (Sample) 0-99c	100UV01PTC0000	On Request
Thin Film Holder	100UVTFH000000	10477.00
0.5ml Quartz Cuvette Pair	100UV005QCP000	14286.00
1.0ml Quartz Cuvette Pair	100UV010QCP000	12381.00
3.5ml Quartz Cuvette Pair	100UV035QCP000	10477.00
50mm pathlength Quartz Cuvette Pair	100UV050QCP000	12381.00
100mm pathlength Quartz Cuvette Pair	100UV100QCP000	19048.00
0.5ml Glass Cuvette Pair	100UV005GCP000	5715.00
1.0ml Glass Cuvette Pair	100UV010GCP000	5715.00
3.5ml Glass Cuvette Pair	100UV035GCP000	3810.00
50mm pathlength Glass Cuvette Pair	100UV050GCP000	9524.00
100mm pathlength Glass Cuvette Pair	100UV100GCP000	14286.00
Dust Cover	100UVDC0000000	1905.00
USB Connection Cable	100UVUSB000000	1048.00
LAN Connection Cable	100UVLAN000000	1048.00
Fuse Set	100UVFUSE00000	477.00
Power Cord	100UVPOWCORD00	1429.00

Primelab 2.0 **NEW PRODUCT**

- Analyze anytime, anywhere. Portable photometer for water analysis
- Primelab 2.0 for all parameter analysis eliminating work of multiple instruments
- Compatible with open chemistry
- Customized pricing as per parameters you need to test
- Cloud syncing and storage of upto 150,000 data points user and location specific



Technical Data & Ordering Information

Model Name	Prime Lab 2.0
Spectral range	390nm - 950nm 18 wavelength, peaks at 410/435/460/485/510/535/560/ 585/610/645/680/705/730/760/810/860/900/940nm 180° and 90° Setup for direct and indirect measurement
Parameters	more than 140 parameters
Electrodes	USB-type-C connector for pH/ EC/ TDS/ ORP/ Temp-Probes
Connectivity (technical)	Bluetooth 4.2 WiFi USB (type C) 4G* (via USB-modem)
Connectivity (software)	LabCOM Software (Windows / Mac) LabCOM App (Android / iOS) LabCOM Cloud (web-browser)
Display	5.5" Color-HD touch display
Camera	In-built barcode / QR-code scanner
Calibration	Auto-calibration function with certificate (software)
One-Time-Zero	Intelligent OTZ (One-Time-Zero) function with recognition of ZERO types
Internal memory	>5,000
Clock/Date	RTC (Real-Time-Clock) with calendar function
Auto-Off	Factory default setting = 10 minutes. Individual adjustment possible
Menu guidance	Intuitive, display-controlled 4-button menu guidance; test instructions during measurement process
Power supply	8,500 mA Li-Io-battery
Languages	>15
Environment	5°C - 45°C / 30 - 90% rel. humidity
Water-proof rating	The device is splash-water-proof (IP54)
Reagents	The calibration curves for the individual parameters / measurement procedures are adjusted to the reagents offered with the unit.
Weight	715g
Dimensions (W × D × H)mm	100 × 59 × 255
HS Code	90275000
Ordering Code	100PL02B000000
Price / Piece	On Request

Accessories provided by default with the kit

- LabCOM App/Software/Cloud (Android, iOS, Windows, Mac, Browser)
- 4 × 24mm/10ml glass-vials with lid (light-shield incorporated into the lid)
- 1 × light shield (for 16mm and 1ml vials as well as check-standards)
- 1 × 24mm vial adapter (built-in; exchangeable)
- 1 × 10.5 cm stirring rod
- 1 × 10ml plastic syringe (graduated)
- 1 × vial cleaning brush
- 1 × microfibre cleaning cloth for vials
- 1 × charger with cable (USB-Type-C)
- 1 × printed user manual in a ring-binder

COD Digestion Unit

Open Reflux COD Digesters-Ideal solutions for waste water analysis



Technical Data & Ordering Information

Model Name	COD082	COD152	COD080	COD150
Reflux Type	Open	Open	Open	Open
Positions	08 Position	15 Position	08 Position	15 Position
Capacity	250 ml × 08 tubes	250 ml × 15 tubes	250 ml × 08 tubes	250 ml × 15 tubes
Heating Block	Aluminium			
Temperature Range	Ambient to 180°C			
Temperature Accuracy	±1°C		±10°C	
Display	Front GRP control panel with Graphic LCD		LED	
Graphical representation of time and temp	Yes		No	
Two point factory calibration	Yes			
PID autotune	Yes			
User presets	Yes			
Process Timer	0 - 999 min			
Temperature Control	Yes with Set value and Present value			
Time Control	Yes with Set value and Present value			
Connectivity to Printer	Yes		No	
Connectivity to PC	Yes		No	
Power consumptions	1400W	1800 W	1200W	1600W
Current Consumption	6 A	8 A	6 A	8 A
Unit External Dimensions (W × D × H)	(414 × 414 × 283)mm		(414 × 414 × 283)mm	
HSN Code	84198990			
Ordering Code	BLFACOD 08200000000	BLFACOD 15200000000	BLFACOD 08000000000	BLFACOD 01500000000
Prices / Piece	On Request			

Description	Ordering Code	Pack Size	Prices / Piece
COD air condensers	BLMACND100 CODSAC00	5	7,120.00
COD digestion vessels	BLMATUB100CODSGT20	5	6,340.00

Note : Digestion vessels and air condensers are provided by default with the unit

Thermoreactor

Closed reflux COD digester
Compact and Convenient



Technical Data & Ordering Information

Model Name	COD120
Reflux Type	Sealing
Positions	12 Position
Capacity	16 mm × 100 mm vials
Heating Block	Aluminium
Temperature Range	Ambient to 180°C
Temperature Accuracy	±1°C
Display	LED
Process Timer	0-999 min / Infinite
Temperature Control	Yes with Set value and Present value
Time Control	Yes with Set value and Present value
Transparent Lid	UV protection
Power consumptions	200 W
Current Consumption	1.5 A
Unit External Dimensions (W × D × H)	(275 × 185 × 150) mm
HSN Code	84198990
Ordering Code	BLFHCOD12000000000
Prices / Piece	On Request

Note : 12 nos. digestion tube provided by default with the unit

Water Baths

Borosil Labquest Premium range of circulating water baths are an ideal choice when temperature uniformity and control are particularly critical along with Data logging connectivity.

Premium Series - Circulating Water Bath

Labquest Premium baths provide more uniform heat convection.

These Heating baths are particularly useful in Routine lab applications, Coliform determinations, Sample thawing, Bacteriological examinations, Microbiological assays, Cell cultivation.



Technical Data & Ordering Information

Model Name	WBP012	WBP015	WBP020
Nominal Capacity	12L	15L	20L
Working Temperature Range	Ambient +5 to 99°C	Ambient +5 to 99°C	Ambient +5 to 99°C
Temperature Accuracy at 37°C	±0.2°C	±0.2°C	±0.2°C
Circulation	By PTFE Stir Bar	By PTFE Stir Bar	By PTFE Stir Bar
Interior Dimension (L × B × H) in mm	330 × 300 × 150 mm	330 × 300 × 200 mm	500 × 300 × 150 mm
Exterior Dimension (L × B × H) in mm	375 × 325 × 450 mm	355 × 325 × 510 mm	550 × 350 × 450 mm
Electrical Requirements	6A	6A	9A
Power Consumption	900 W	900 W	2000 W
External Temperature Probe	PT1000	PT1000	PT1000
USB Interface - Data Logging	USB	USB	USB
Lid Type	SS Lid with 6 position Concentric Rings	PC Lid	SS Lid with 8P Lid position Concentric Rings
HSN Code	84198990		
Ordering Code	BLFHWP01200000000	BLFHWP01500000000	BLFHWP02000000000
Prices / Piece	67,500.00	73,100.00	95,600.00

High Capacity Baths

Model Name	WBP024	WBP035	WBP060
Nominal Capacity	24L	35L	60L
Working Temperature Range	Ambient +5 to 99°C	Ambient +5 to 99°C	Ambient +5 to 99°C
Temperature Accuracy at 37°C	±0.2°C	±0.2°C	±0.2°C
Circulation	By PTFE Stir Bar	By PTFE Stir Bar	By PTFE Stir Bar
Interior SS304 Dimension (L × B × H)	500 × 300 × 200 mm	650 × 350 × 150 mm	650 × 350 × 200 mm
Exterior SS304 Dimension (L × B × H)	550 × 335 × 510 mm	675 × 375 × 450 mm	675 × 375 × 475 mm
Electrical Requirements	12A	15A	20A
Power Consumption	2200W	3000W	5000W
External Temperature Probe	PT1000	PT1000	PT1000
USB Interface - Data Logging	USB	USB	USB
Lid Type	SS Lid with 8 position Concentric Rings	SS Canopy	SS Canopy
HSN Code	84198990		
Ordering Code	BLFHWP02400000000	BLFHWP03500000000	BLFHWP06000000000
Prices / Piece	On Request	On Request	On Request

Water Baths

The Elemental Series of general purpose Water Baths offers variety of sizes to meet all your needs and is ideal for lab applications.

Elemental Series - Constant Temperature Baths

Elemental Series Water Baths can be used for a wide variety of purposes, including routine laboratory tasks, holding samples at a constant temperature, incubation, materials testing, corrosion testing, temperature control of cultures, thermal testing of food and dental applications. In this series temperature uniformity is obtained by convection gradually.



Also available in WLS series with overhead stirring

Technical Data & Ordering Information

Model Name	WLC005	WLC012	WLC020
Nominal Capacity	5L	12L	20L
Working Temperature	Ambient +	Ambient +	Ambient +
Range	5 to 99°C	5 to 99°C	5 to 99°C
Temperature Accuracy at 37°C	±0.5°C	±0.5°C	±0.5°C
Circulation		By Convection Only	
Interior Dimension (L × B × H) in mm	300 × 152 × 150	330 × 300 × 150	500 × 300 × 150
Exterior Dimension (L × B × H) in mm	325 × 180 × 300	375 × 325 × 300	550 × 350 × 300
Power Consumption	2A, 230V, 400W	4A, 230V, 900W	9A, 230V, 1600W
HSN Code		84198990	
Ordering Code	BLFHWLC00500000000	BLFHWLC01200000000	BLFHWLC0200000000
Prices / Piece	38,200.00	46,000.00	53,500.00

Optional Accessories

Model Name	Ordering Code	Suitable For	Prices / Piece
5 L			
3 Hole SS LID Assembly	BLAHWLC005LID00003	WLC005	2,800.00
5L Polycarbonate LID Assembly	BLAHWLC005PCLID000	WLC005	4,300.00
12 L			
6 Hole SS LID Assembly	BLAHWLC012LID00006	WLC012	3,900.00
12/15 Polycarbonate LID Assembly	BLAHWLC012PCLID000	WLC012	5,100.00
20 L			
8 Hole SS LID Assembly	BLAHWLC020LID00008	WLC020	5,300.00
12 Hole SS Lid Assembly	BLAHWBA02000000012	WLC020	9,000.00
20 Ltr Polycarbonate Lid ASM	BLAHWBA020CAPP000	WLC020	7,100.00
Ball Shield Anti-evaporation Spheres (Ø37mm × 500 nos)	BLAHWLS020BALLID00	All Baths	8,200.00

* SS Gabled / Dome lid for bath are also available price on request

Ultrasonic Baths

Ultrasonic Bath offers gentle effective cleaning action ensuring that no contaminants get carried over from the previous process.

Sonicator Bath

Ultrasonic Baths use sound waves and liquid to clean small objects. Borosil Labquest digital series of Ultrasonic cleaners come in four different sizes. These stainless steel cleaners feature a bright LED display for time and temperature and easy push-button control along with degs functions.



Technical Data & Ordering Information

Model Name	UCB025	UCB050	UCB100	UCB200
Capacity	1.5L	5L	10L	20L
Working Temperature Range	Ambient +5 °C to 80°C			
Frequency	40kHz			
Time setting	1- 99 mins			
Interior Dimension (L × B × H) in mm	150 × 140 × 100	300 × 155 × 150	300 × 240 × 150	500 × 300 × 150
Exterior Dimension (L × B × H) in mm	190 × 170 × 220	330 × 180 × 330	330 × 270 × 330	550 × 330 × 330
Ultrasonic Power	50 W	150W	200W	400W
Heater Power	100W	300W	500W	500W
HSN Code	84798999			
Ordering Code	LQLEUCB 02500000000	LQLEUCB 05000000000	LQLEUCB 10000000000	LQLEUCB 20000000000
Prices / Piece	29,600.00	45,600.00	75,100.00	97,200.00

Oil Baths

Precision Oil bath build in 100% SS offers controlled heating upto 240°C.

Still & Stirred Oil Baths

Precision oil baths for controlled heating & tempering applications with a temperature accuracy of + 1°C and a built in 100% SS construction. Baths are insulated for user protection and equipped with overshoot control. Baths can also be used with water.



Technical Data & Ordering Information

Model Name	OMC250	OMC010
Working Temperature Range	Ambient +5°C to 240°C	
Circulation	Convection	
Nominal Capacity	750ml	3057ml
RB Flask	250ml	1000ml
Interior Dimension (D × H) in mm	120 × 86	182 × 142
Exterior Dimensions (L × B × H) in mm	203 × 169 × 209	273 × 240 × 263
Power Consumption	300W	800W
HSN Code	84198990	
Ordering Code	BLFHOMC25000000000	BLFHOMC01000000000
Prices / Piece	31,000.00	36,000.00

*Interior tanks are cylindrical in shape.

Technical Data & Ordering Information

Model Name	OMS250	OMS010	OMS020
Working Temperature Range	Ambient +5°C to 240°C		
Circulation	PTFE Stir Bar		
Nominal Capacity	750ml	3057ml	7500ml
RB Flask	250ml	1000ml	2000ml
Interior Dimension (D × H) in mm	120 × 86	182 × 142	217x 209
Exterior Dimensions (L × B × H) in mm	203 × 169 × 209	273 × 240 × 263	302 × 280 × 410
Power Consumption	300W	800W	1500W
HSN Code	84198990		
Ordering Code	BLFHOMS25000000000	BLFHOMS01000000000	BLFHOMS02000000000
Prices / Piece	34,800.00	39,900.00	87,100.00

Data Logger

Measure & Record progress of set parameters

Labquest instruments with USB connectivity e.g. Industrial Stirrers and Premium Water Baths facilitate data logging. Borosil Data Logger continuously monitors and records the activity performed by connected instruments over a period of time. Users can take the print out for specified period and operation. PNP010 a reliable, cost and time-efficient monitoring solution for any measuring & recording progress of set parameters offering key advantages by providing high accuracy and ease of use.



Key Features

Records user level activity with Instrument attached

Login feature supports administrator and up to 99 users with display 128x64 GLCD

Any time print option for logged data records

Customizable print format with company name, lab/department name and process parameters

Technical Data & Ordering Information

Ordering Code	Prices / Piece
BLFAPNP0100000000	On request

Water Distillation Unit

General laboratory applications requiring higher ionic purity, samples & buffer preparations

On Demand Single Distillation Unit (SDU)

Single Stage Distillation units provide automatic working for getting pure water by distillation method capable of removing a wide spectrum of impurities. Raw water is boiled to produce steam which is taken to a condenser where it returns to the liquid state, free of impurity. The impurities remain in the boiler and can be removed periodically with the help of in built descaling or cleaning guide.



Technical Data & Ordering Information

Model Name	SDU1500	SDU2500	SDU4000
Capacity Distilled Water Output	1.5 LPH	2.5 LPH	4 LPH
Minimum cooling water requirement (Ltr/min)	1	1.5	2
Heater	Quartz	Quartz	Quartz
Boiler	Boro 3.3	Boro 3.3	Boro 3.3
Condenser	Boro 3.3	Boro 3.3	Boro 3.3
Biological Activity	Pyrogen Free	Pyrogen Free	Pyrogen Free
Conductivity S/cm*	$<3 \times 10^{-6}$	$<3 \times 10^{-6}$	$<3 \times 10^{-6}$
Power consumption (kw)	1.5kW	2.5kW	3.5kW
Voltage (V)	230V	230V	230V
Dimensions (L x B x H) in mm		650 x 255 x 440	
HSN Code		84198990	
Ordering Code	BLFRSDU15000000000	BLFRSDU25000000000	BLFRSDU40000000000
Prices / Piece	45,800.00	63,900.00	71,000.00

* Inlet water TDS < 100 ppm

Note: Because of difficulties associated with measurement of the pH value of high purity water and the doubtful significance values obtained, limits for the pH value of grade 1 & grade 2 water have not been specified. Conductivity specified applies for freshly prepared water in absence of Carbon Dioxide at 20° C.

Water Distillation Unit

General laboratory applications requiring higher ionic purity, samples & buffer preparations

On Demand Double Distillation Unit (DDU)

Double Stage Distillation Units provide automatic working for getting pure water by distillation method capable of removing a wide spectrum of impurities. Raw water is boiled to produce steam which is taken to a condenser where it returns to the liquid state, free of impurity. The impurities remain in the boiler and can be removed periodically with the help of in built descaling or cleaning guide.



Technical Data & Ordering Information

Model Name	DDU1500	DDU2500	DDU4000
Capacity Distilled Water Output	1.5 LPH	2.5 LPH	4 LPH
Minimum cooling water requirement (Ltr/min)	1	1.5	2
Heater	Quartz	Quartz	Quartz
Boiler	Boro 3.3	Boro 3.3	Boro 3.3
Condenser	Boro 3.3	Boro 3.3	Boro 3.3
Biological Activity	Pyrogen Free	Pyrogen Free	Pyrogen Free
Conductivity S/cm*	<3 × 10 ⁻⁶	<3 × 10 ⁻⁶	<3 × 10 ⁻⁶
Power consumption (kw)	3 kW	4.4 kW	7 kW
Voltage (V)	230V	230V	230V
Dimensions (L × B × H) in mm	640 × 630 × 520		
HSN Code	84198990		
Ordering Code	BLFRDDU150000000000	BLFRDDU250000000000	BLFRDDU400000000000
Prices / Piece	72,400.00	1,17,400.00	1,27,700.00

* Inlet water TDS < 100 ppm

Note: Because of difficulties associated with measurement of the pH value of high purity water and the doubtful significance values obtained, limits for the pH value of grade 1 & grade 2 water have not been specified. Conductivity specified applies for freshly prepared water in absence of Carbon Dioxide at 20° C.

Quartz Double Distillation Unit

On Demand Double Distillation Unit (DDU)

Double Stage Quartz Distillation Units provide automatic working for getting pure water by distillation method capable of removing a wide spectrum of impurities. Raw water is boiled to produce steam which is taken to a condenser where it returns to the liquid state, free of impurity. The impurities remain in the boiler and can be removed periodically with the help of in built descaling or cleaning guide.



Technical Data & Ordering Information

Model Name	QDD250
Type	Benchtop - Open
Capacity Distilled water Output	2.5LPH
Minimum cooling water requirement (Ltr/min)	1.5
Heater	Quartz
Boiler	Quartz
Condensor	Quartz
Biological Activity	Pyrogen Free
Distillation Temperature	65 - 75°C
Conductivity S/cm*	<1 × 10 ⁻⁶
Power consumption (kw)	5.5kW
Voltage (V)	230-250 V
Dry Run Protection	Yes
Dimensions in mm (W × D × H)	650 × 630 × 520
On Demand Output	Yes
Order Code	BLFRQDD25000000000
HSN Code	84194090
Prices / Piece	2,48,000.00

* Inlet water TDS < 100 ppm

Note: Because of difficulties associated with measurement of the pH value of high purity water and the doubtful significance values obtained, limits for the pH value of grade 1 & grade 2 water have not been specified.

Quartz Cabinet Distillation

**NEW
PRODUCT**

On Demand Quartz Double Distillation Unit (QCD)

Double Stage Quartz cabinet units with reservoir provide automatic working with safety cut-offs for dry-run/unstable water flow. It also offers dispensing serially or continuously from reservoir storage.



Technical Data & Ordering Information

Model Name	QCD 250
Orientation	Vertical
Design	Bench Top Cabinet
Capacity Distilled water Output	2.5LPH
Minimum cooling water requirement (Ltr/min)	2
Dimensions (L*B*H) along with reservoir	730 × 730 × 1020
Heater	Quartz
Boiler	Quartz
Condensor	Quartz
Biological Activity	Pyrogen Free
Conductivity S/cm*	<1 × 10 ⁻⁶
Power consumption (kw)	4.4kW
Voltage (V)	230 V
Dry Run Protection	Yes
On Demand Output	Yes
Storage Mode	Yes
Auto Filling Reservoir	Yes
Dispense rate (ml/min)	900ml
Order Code	BLFRQCD25000000000
HSN Code	84194090
Prices / Piece	2,87,900.00

*1 Inlet water TDS < 100 ppm

Note: Because of difficulties associated with measurement of the pH value of high purity water and the doubtful significance values obtained, limits for the pH value of grade 1 & grade 2 water have not been specified. Conductivity specified applies for freshly prepared water in absence of Carbon Dioxide at 20°C. Conductivity values are affected by temperature and absorbed carbon dioxide quantity along with other contaminants from containers stored.

Water Distillation Unit

Manufactured from quartz, providing quick & continuous purified water with smaller foot print in laboratories.

Mono Quartz Distillation Units (Manual)

These Innovative and compact vertical Distillation Units Made from Pure Silica - Quartz are ideal choice for getting single stage distilled water. It meets the standard of the analytical laboratory where purity of distilled water free from metallic ions and bacteria is important.



Technical Data & Ordering Information

Model Name	3363042	3363033	3363038	3364042	3364033
Capacity Distilled Water Output	2.5 LPH	5 LPH	10LPH	2.5LPH	5LPH
Minimum cooling water requirement (Ltr/min)	1	2	2.5	1	2
Heater	Quartz	Quartz	Quartz	Quartz	Quartz
Boiler	Quartz	Quartz	Quartz	Quartz	Quartz
Condenser	Boro 3.3	Boro 3.3	Boro 3.3	Quartz	Quartz
Biological Activity	Pyrogen Free	Pyrogen Free	Pyrogen Free	Pyrogen Free	Pyrogen Free
Conductivity S/cm*	<3 × 10 ⁻⁶	<3 × 10 ⁻⁶	<3 × 10 ⁻⁶	<3 × 10 ⁻⁶	<3 × 10 ⁻⁶
Power consumption (kw)	2.2 kW	4.4kW	8.8 kW	2.2 kW	4.4 kW
Voltage (V)	230V	230V	440V - 3Phase	230V	230V
HSN Code	841940901				
Ordering Code	BT533363042	BT533363033	BT533363038	BT533364042	BT533364033
Model Prices / Piece	45,300.00	85,800.00	1,96,000	78,200.00	1,50,000.00
Accessory - DAPS Code	3366342	3366333	3366338	3366442	3366433
DAPS Prices / Piece	15,700.00	17,530.00	32,470.00	15,700.00	17,420.00

* Inlet water TDS < 100 ppm

DAPS - The Unit provides for Automatic working of distillation unit by switching off the heaters in case water level falls below the heating coil, thereby safeguarding the heaters. The unit resumes distillation when water level is restored by pushing reset button on front panel. The water level sensor probe works on 12 V and hence is very safe to handle. The unit also comes with Buzzer. DAPS is unique for each model.

Note: Because of difficulties associated with measurement of the pH value of high purity water and the doubtful significance values obtained, limits for the pH value of grade 1 & grade 2 water have not been specified. Conductivity specified applies for freshly prepared water in absence of Carbon Dioxide at 20°C.

Water Distillation Unit

All quartz innovative & compact design offers consistent purified water in two distillation stages

All Quartz Double Distillation Units

Quartz distillation units are manufactured from fused quartz tubes. The exceptionally high chemical purity and very low solubility of this material enables the production of very high performance system. The greatest possible attention has been taken for technical performance, simplicity of use and efficiency.



Technical Data & Ordering Information

Model Name	3365041	3365042	3365033
Capacity Distilled Water Output	1.5 LPH	2.5 LPH	5 LPH
Minimum cooling water requirement (Ltr/min)	1	2	2.5
Heater	Quartz	Quartz	Quartz
Boiler	Quartz	Quartz	Quartz
Condenser	Quartz	Quartz	Quartz
Biological Activity	Pyrogen Free	Pyrogen Free	Pyrogen Free
Conductivity S/cm*	<1 × 10 ⁻⁶	<1 × 10 ⁻⁶	<1 × 10 ⁻⁶
Power consumption (kw)	3 kW	4.4kW	8.8 kW
Voltage (V)	230V	230V	440V - 3Phase
HSN Code		84194090	
Ordering Code	BT533365041	BT533365042	BT533365033
Model Prices / Piece	1,30,100.00	2,28,800.00	4,07,200.00
Accessory - DAPS	3366541	3366542	3366533
DAPS Prices / Piece	16,670.00	17,420.00	32,900.00

* Inlet water TDS < 100 ppm

DAPS - The Unit provides for Automatic working of distillation unit by switching off the heaters in case water level falls below the heating coil, thereby safeguarding the heaters. The unit resumes distillation when water level is restored by pushing reset button on front panel. The water level sensor probe works on 12 V and hence is very safe to handle. The unit also comes with Buzzer. DAPS is unique for each model.

Note: Because of difficulties associated with measurement of the pH value of high purity water and the doubtful significance values obtained, limits for the pH value of grade 1 & grade 2 water have not been specified. Conductivity specified applies for freshly prepared water in absence of Carbon Dioxide at 20°C.

Accessories for Distillation Units

On Demand Glass Distillation Units Spares

Product Code	Description
BLA0CRH12KW15LHQRT	Ceramic Heater_Quartz tube-1.5L Accs
BLA0CRH02KW25LHQRT	Ceramic Heater_Quartz tube-2.5L Accs
BLA0CRH03KW04LHQRT	Ceramic Heater_Quartz tube-4L Accs
BLAPSDU1500BOIL000	WDU 1.5LTR BOILER ACCS
BLAPSDU2500BOIL000	WDU 2.5LTR BOILER ACCS
BLAPSDU4000BOIL000	WDU 4.0LTR BOILER ACCS
BLAPSDU1500CON0000	1.5 LTR CONDENSER ACCS
BLAPSDU2500CON0000	2.5 LTR CONDENSER ACCS
BLAPSDU4000CON0000	4.0 LTR CONDENSER ACCS
BT603367000	Water Softner

Mono Quartz Units Spares

Product Code	Description
363012	Quartz Boiler 2.5LPH
363032	Quartz Boiler 5LPH
363502	Quartz Boiler 10LPH
362022	Borosilicate Condenser 2.5LPH
0363S00	Borosilicate Condenser 5LPH
0363S03	Borosilicate Condenser 10LPH
364023	Quartz Condenser 2.5LPH
364501	Quartz Condenser 5LPH

All Quartz Double Distillation Spares

Product Code	Description
362013	Primary Quartz Boiler 1.5LPH
362014	Primary Quartz Boiler 2.5LPH
0362S04	Primary Quartz Boiler 5LPH
362015	Quartz Secondary Boiler - Condenser 1.5LPH
362016	Quartz Secondary Boiler - Condenser 2.5LPH
0363S05	Quartz Secondary Boiler - Condenser 5LPH
362063	Receiving Adapter with Spring
362052	Silicon "O" Ring

All Glass Manual Units

Product Code	Description
336011	Borosilicate Boiler with Water Leveller 1.5LPH
336031	Borosilicate Boiler with Water Leveller 2.5LPH
336021	Borosilicate Boiler with Water Leveller 4.0LPH
0336012R	Primary Quartz Heater (RED) 1.5LPH
0336013R	Primary Quartz Heater (RED) 2.5LPH
0336022R	Primary Quartz Heater (RED) 4.0LPH
0336012B	Secondary Quartz Heater (Blue) 1.5LPH
0336013B	Secondary Quartz Heater (Blue) 2.5LPH
0336022B	Secondary Quartz Heater (Blue) 4.0LPH
361021	Condenser for Unit 1.5LPH
361041	Condenser for Unit 2.5LPH
362021	Condenser for Unit 4.0LPH

Overhead Stirrer **NEW PRODUCT**

Labquest by Borosil presents a range of overhead stirrers designed for stirring and mixing tasks in the laboratory, catering to low to high viscosities.

Overhead stirrers are crafted to meet the diverse needs of laboratory applications, providing reliable and efficient solutions for stirring and mixing tasks. BLDC, Microprocessor, Compact, Overload Protection.

- Stirring quantities of up to 100 liters.
- Brushless DC motor
- Micro-processor controlled technology.
- Reversible mixing Motions
- Compact and totally enclosed casing for enhanced safety.
- Adjustable push through impeller shaft to accommodate different heights/vessels
- Internal overload protection for added safety.



Technical Data & Ordering Information

Model Name	OHS15	OHS20	OHS40	OHS50	OHS75	OHS100
Stirring quantity max [L / H ₂ O]	20L	25L	40L	50L	75L	100L
Speed range [rpm]	50-1000	50-2000	50-1000	60-2000	60-2000	60-1300
Max Torque [N-cm]	15Ncm	20Ncm	40Ncm	50Ncm	75Ncm	100Ncm
Max Viscosity	8000mPas	10000mPas	30000mPas	30000mPas	50000mPas	70000mPas
Motor	BLDC	BLDC	BLDC	BLDC	BLDC	BLDC
Power	24V/36W	24V/36W	24V/36W	24V/72W	24V/72W	24V/72W
Change of Rotation Direction	Yes	Yes	Yes	Yes	Yes	Yes
Speed / Timer Display	Digital LED	Digital LED	Digital LED	Digital LED	Digital LED	Digital LED
Impeller Adjustment	Push Through	Push Through	Push Through	Push Through	Push Through	Push Through
Overload Protection	Yes	Yes	Yes	Yes	Yes	Yes
Over Temperature Protection	Yes	Yes	Yes	Yes	Yes	Yes
Auto Resume - Power Interruption	Yes	Yes	Yes	Yes	Yes	Yes
Smart Control Feature	Yes	Yes	Yes	Yes	Yes	Yes
IP Rating	IP54	IP54	IP54	IP42	IP42	IP42
Chuck range diameter [mm]	1-10mm	1-10mm	1-10mm	1-10mm	1-10mm	1-10mm
Timer	1-99min OR Continuous					
Dimensions (L x W x H) [mm]	176X173X79	176X173X79	176X173X79	102X242X249	102X242X249	102X242X249
Weight [kg]	1.7kg	1.7kg	1.7kg	5kg	5kg	5kg
HSN	84798200					

* Chuck, Impellers, stand & boss head clamp to be ordered separately









Overhead Stirrer

Technical Data & Ordering Information

Description	Item code	Price/pc
OHS15 15Ncm 20L 1000RPM 8000mPas	LQLEOHS015020PR000	29,000.00
OHS20 20Ncm 25L 2000RPM 10000mPas	LQLEOHS020025PR000	40,700.00
OHS40 40Ncm 40L 1000RPM 30000mPas	LQLEOHS040040PR000	42,600.00
OHS50 50Ncm 50L 2000RPM 30000mPas	LQLEOHS050050E0000	66,400.00
OHS75 75Ncm 75L 2000RPM 50000mPas	LQLEOHS075075E0000	70,300.00
OHS100 100Ncm 100L 1300RPM 70000mPas	LQLEOHS100100E0000	72,800.00

* Chuck, Impellers, stand & boss head clamp to be ordered separately

Impellers

Description	Item code	Flow Type	Dia	Max RPM	Viscosity Range	Blade Type	Price/pc
Propeller Impeller (50X8X550 mm)Axial	LQLEOHA5008550PIA0	Axial	50	2000	0-10000		2200.00
Propeller Impeller (100X15X550 mm)Axial	LQLEOHA10015550PIO	Axial	100	800	0-20000		3800.00
Propeller Impeller (130X15X800 mm)Axial	LQLEOHA13015800PIO	Axial	130	800	0-30000		5300.00
CrossWelded Impeller (50X12X550mm)Radial	LQLEOHA5012550CWIO	Radial	50	2000	0-10000		3200.00
StraightB Impeller (35X12X550mm)Radial	LQLEOHA3512550SBIO	Radial	35	2000	0-10000		2900.00
StraightB Impeller (50X12X550mm)Radial	LQLEOHA5012550SBIO	Radial	50	2000	0-10000		3600.00
PivotingB Impeller (60X15X550mm)Radial	LQLEOHA6015550PBIO	Radial	60	1800	0-10000		3800.00
CollapsibleB Impeller (80X10X550mm)Radial	LQLEOHA8010550CBI1	Radial	80	1500	0-10000		3400.00

Description	Item code	Flow Type	Dia	Max RPM	Viscosity Range	Blade Type	Price/pc
SquareB Impeller(38X38X550mm) Tangential	LQLEOHA3838550SB11	Tangential	38	1000	0-30000		3900.00
SquareB Impeller (70X70X800mm)Tangential	LQLEOHA7070800SB11	Tangential	70	600	0-50000		5100.00
AnchorB Impeller (45X45X550mm)Tangential	LQLEOHA4545500AB10	Tangential	45	800	0-100000		3800.00
AnchorB Impeller (90X80X800mm)Tangential	LQLEOHA9080800AB10	Tangential	90	600	0-100000		5400.00
PaddleB Impeller (70X70X550 mm)Tangential	LQLEOHA7070550PB10	Tangential	70	800	0-100000		4900.00
PaddleB Impeller (70X70X800 mm)Tangential	LQLEOHA7070800PB10	Tangential	70	600	0-100000		5800.00
PaddleB Impeller (70X80X550 mm)Tangential	LQLEOHA7080550PB10	Tangential	70	800	0-100000		4900.00
PaddleB Impeller (70X80X800 mm)Tangential	LQLEOHA7080800PB10	Tangential	70	600	0-100000		5800.00

Stands / Clamps / Chuck

Description	Item code	Price/pc
PlateStand 220X320 mm Rod560mm 5L	LQLEOHA2232560PS01	10800.00
PlateStand 220X320 mm Rod800mm 5L	LQLEOHA2232800PS02	11700.00
PlateStand 220X320 mm Rod1000mm 5L	LQLEOHA2232100PS03	12700.00
Bosshead Clamp for Plate Stand PROHS	LQLEOHA00001BHCPR0	4200.00
Bosshead Clamp for Plate/H stand PR OHS	LQLEOHA00001BHCPR1	4000.00
Only H Stand 500x 450x 1020mm	LQLEOHA5045102HS01	25000.00
Bosshead Clamp for H-Stand	LQLEOHA00001BHCH01	5000.00
OHS Key Chuck	LQLEOHA00000OHKC001	6200.00
OHS Keyless Chuck	LQLEOHA00000OHKC002	7600.00
OHS Collet Chuck	LQLEOHA00000OHKC003	1000.00
OHS Chuck Cover	LQLEOHA00000OHKC004	200.00

Laboratory Stirrers

Compact magnetic stirrer with digital display offering accurate speed, timer, temperature setting

Magnetic Stirrers - Heat & Stir applications

These stirrers offer accurate, stable and highly-reproducible in various heating & stirring experiments involving low viscous fluids.



Technical Data & Ordering Information

Model Name	HLS200	MHPS550P Premier
Stirring Position	1	1
Max Capacity	2L	20L
Max Speed for H ₂ O	1500 rpm	up to 2200
Timer	0 - 999 min OR Continuous	0 - 999 min OR Continuous
Plate Temperature	Ambient +5 °C - 300 °C	Ambient +5 °C - 550 °C
Safe Temperature Setting	Yes	Yes
Hot Indicator when Plate is above 50 °C	Yes	Yes
Pulse Mode	NA	Yes
Display	LED Digital	Dual Set & Actual Temp, RPM & Time
Plate Material	SS	Ceramic
Power Consumption	2Å, 230V, 325W	5Å, 230V, 1000W
Magnetic Bar	25 mm	25 mm
Top Plate Dimensions (L × B) in mm	150 × 155	180 × 180
Product Dimensions (L × B × H) in mm	260 × 190 × 155	313 × 212 × 110
Protection Class	IP21	IP21
Supplied with	PT100 Probe only	PT1000 Probe & Stand
HSN Code	84798200	
Ordering Code	BLFHLS200000000000	100MHPS010550P
Prices / Piece	15,230.00	57,500.00

Optional Accessories

Description	Ordering Code	Suitable for
PT100 DIN Connector	BLA0DIN00MX0005PIN	HLS200
PT1000 Probe	100MHPS01PT100	MHPS550P Premier
Probe Stand	100MHPS01PS000	MHPS550P Premier

Note: 100MHPS0103500 model is also available, till stocks last. (P.O.R.)

Hot Plate Stirrer

**NEW
PRODUCT**

Labquest hot plate stirrer 'SRS005' can be paired with parallel reaction stations designed to increase productivity, save space and reduce costs. These parallel reaction assemblies are useful in applications such as heating, cooling, condensing, work up, evaporation, inerting, filtration, heating, parallel synthesis, polymer research, process development, refluxing and stirring.

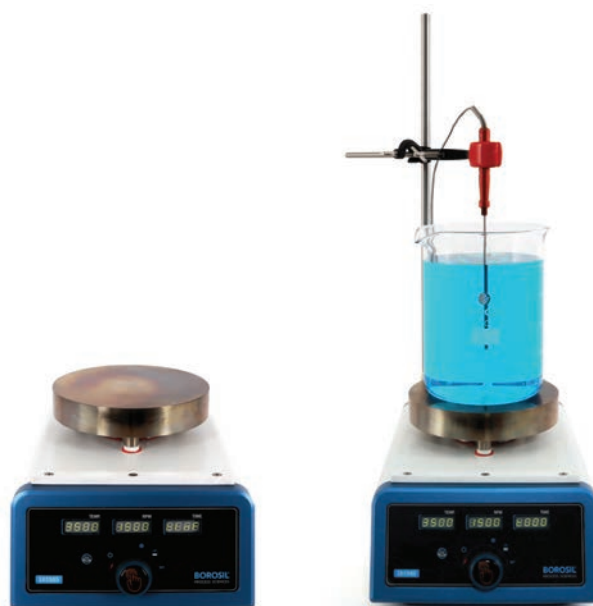

* Stand not included in package

Technical Data & Ordering Information

Model Name	SRS005
Stirring Positions	1
Max Capacity	5 L
Max Speed for H ₂ O	2000
Timer	upto 999 min or Continuous Mode
Plate Temperatures upto °C	350 °C
Temperature Accuracy	Operation with external temperature measuring sensor Pt1000: ± 0.2 K
Safe Temperature Setting	Yes
Hot Indicator when Plate is above 50 °C	Yes
Pulse Mode	NA
Display	3 × 4 Digit Seven Segment Display
Temperature Increments	Yes
Stirring RPM Increments	Yes
Top Plate Material	Stainless Steel
MOC Body	Aluminium
Power Consumption	2 kW
Magnetic Bar	Yes
Top Plate Dimensions	∅168 mm
Safety Warning for Plate Temp above 50 °C	Yes
IP Protection Class	IP21
Supplied with Probe Specs	PT1000 Probe
Drive	BLDC motor 28 watts
Rotation speed range	100 – 1500 rpm
Heating power	1000 watts @ 230 V
Temperature range	RT – 350 °C, setting accuracy 1 °C for Plate
Heating control	PID
Power input	230 V, 50 Hz, 6 A
Product Dimensions (L × B × H) in mm	360 × 215 × 160 mm (approx)
Ordering Code	BLFHRS00500000000*
Prices / Piece	On Request

Note: Parallel Reaction Station Accessory needs to be procured separately.

Stirrers - Max Stir

Outstanding stirring for high-volume applications in process equipments with USB Data Logging options

Industrial Max Stir MGS Series

Industrial Max-Stir are designed for chemical and biotechnical applications of all kinds that are within the field of quality insurance and pilot plant stations, it can also be integrated with high capacity process equipments, developed for highest demands, unbeatably strong, high stability with uncompromising continuous operation.



Technical Data & Ordering Information

Model Name	MGS020	MGS050	MGS200
Number of stirring positions		1	
Stirring quantity	Upto 20 L	Upto 50 L	Upto 200 L
Motor Type	BLDC 15 motor	BLDC 30 motor	
Stirring bar length	35 - 80 (in mm)	80 - 120 (in mm)	155 (in mm)
Material Housing		304 Stainless steel	
Display		Digital LCD Display	
Speed range	0 - 1000 rpm	0 - 600 rpm	
Timer	(0 - 99:99 hrs:min) or continuous/infinite operation		
Set-up plate dimensions in mm	300 × 300	400 × 400	500 × 500
Dimensions (L × B × H) mm	300 × 390 × 110	400 × 490 × 110	500 × 590 × 110
Weight of the Product	12 Kgs	14 Kgs	25 Kgs
Weight / Load (it can Sustain)	30 Kgs	70 Kgs	70Kgs
Process Equipments Indirect Load It can stir	Volumes up to 20L	Volumes up to 50L	Volumes up to 200L
Ramp Rate	Adjustable for different viscosity		
USB Interface (Upgradable)	YES - Option to connect Labquest Data Logger & Printer		
Permissible temperature	5 °C to 40 °C		
Max Current	0.3 A	0.5 A	
Motor rating output	30W	60W	
HSN Code	90278090		
Ordering Code	BLFHMG02000000000	BLFHMG05000000000	BLFHMG20000000000
Prices / Piece	On Request		

Stirrers

Compact multiposition magnetic stirrer with digital display offering accurate speed, timer, temperature setting

Magnetic Stirrers with Heating - Multiple Position

Multi-position Hot Plate Magnetic Stirrer is used widely for liquid heating mixing parallel and series of experiments. It is the essential mixing instrument for biology, heredity, medicine and health, environmental protection and biochemistry laboratories.



Technical Data & Ordering Information

Model Name	MHPS 5P	MHPS 10P	MHPS 15P
Stirring Position	5	10	15
Plate Temperature	120°C	120°C	120°C
Max Capacity	5 × 250ml	10 × 250 ml	15 × 250 ml
Max Speed	1500 rpm	1500 rpm	1500 rpm
Timer	1-999 min	1-999 min	1-999 min
Motor Type	BLDC	BLDC	BLDC
Pulse Mode	Yes	Yes	Yes
Display	Digital	Digital	Digital
Plate Material	Stain less steel plate with silicone sheet		
Power Consumption	450W	450W	800W
Magnetic Bar	25 mm	25 mm	25 mm
Top Plate Dimensions (L × B) in mm	565 × 136	565 × 196	565 × 282
Product Dimensions (L × B × H) in mm	565 × 136 × 75	565 × 196 × 75	565 × 282 × 75
Protection Class	IP42	IP42	IP42
HSN Code	84798200		
Ordering Code	100MHPS0515000	100MHPS1015000	100MHPS1515000
Prices / Piece	55,400.00	77,100.00	1,12,600.00



5 position



10 position



15 position

Laboratory Stirrers

Compact magnetic stirrer with digital display offering accurate speed, timer setting

Magnetic Stirrers - Stir only applications

A magnetic stirrer is a laboratory device that employs a rotating magnetic field to cause a stir bar immersed in a liquid to spin very quickly, thus stirring it. It finds applications in chemistry & biology experiments involving Dilution, Maintaining suspensions, Homogenisation and Dissolution, Emulsions in a laboratory.



Technical Data & Ordering Information

Model Name	MGS001	MS One	MS Four	MLS010	MLS050
Stirring Position	1	1	4	1	1
Max Capacity	upto 5L	800ml	4 × 400ml	10L	50L
Max Speed	2200 RPM	1500 RPM	1200 RPM	upto1000 RPM	upto1000 RPM
Timer	0-999 min	1-99min	1-99min	Continuous	Continuous
Pulse Mode	NA	Yes	Yes	NA	NA
Display	LED	Digital	Digital	LED	LED
Plate Material	SS304	SS304	SS304	SS	SS
Type of Motor	AC	Motorless	Motorless	BLDC	BLDC
Slip Detection	NA	NA	NA	Yes	Yes
Power Consumption	1Å, 230V, 25W	1.5Å, 12V, 5W	2Å, 9V, 13W	1.5Å, 12V, 30W	2Å, 12V, 60W
Magnetic Bar	25mm	25mm	25mm	25, 35, 50, 60	25, 35, 50, 60
Top Plate Dimensions (L × B) in mm	189 × 208	150 × 100	385 × 182	250 × 250	370 × 370
Product Dimensions (L × B × H) in mm	284 × 188 × 120	156 × 110 × 14	457 × 126 × 14	310 × 250 × 100	430 × 370 × 100
Protection Class	IP21	IP65	IP65	IP42	IP42
HSN Code	90278090				
Ordering Code	BLFHMG5 00100000000	100MS0 00115000	100MS0 00412000	BLFHML S01000000000	BLFHML S05000000000
Prices / Piece	9,980.00	15,900.00	31,700.00	38,100.00	59,000.00

Hot Plates

Precise digital temperature control and timer function

Rectangular Hot Plates

Labquest microprocessor PID controlled Hot Plates offers uniform & precise heating along with safe working. It finds applications in acid and base digestions, trace metal analysis, sample drying, general reagent heating, evaporation, cytological & histological studies. These products are widely used in industries such as chemicals, automobile & pharmaceutical laboratories.



Technical Data & Ordering Information

Model Name	HPL020	HPL030	HPL400
Max Capacity - Beaker	500ml Beaker × 12 pc	500ml Beaker × 18 pc	2L Beaker
Max Plate Temperature		up to 300°C	
Timer		Digital Timer	
Display		LED Display	
Plate Material	Aluminium	Aluminium	SS 304 Top Plate
Power Consumption	2000W	3000W	400W
Top Plate Dimensions (L × B)mm	300 × 450	450 × 600	155 × 150
Product Dimensions (L × B × H) mm	300 × 450 × 200	450 × 600 × 200	260 × 190 × 155
HSN Code		84798200	
Ordering Code	BLFHHPLO2000000000	BLFHHPLO3000000000	BLFHHPLO4000000000
Prices / Piece	61,430.00	74,240.00	9,980.00

Laboratory Stirrer Accessories

Aluminium Blocks & Stir Bars are basic accessories that promote safe & better heat transfer while using RB Flask or Reaction Tubes on a Hot Plate

Aluminum Heating Blocks

The aluminum heating reaction blocks provides safe working. The accessories blocks are used with various hot plate stirrers & suitably replace oil bath & heating mantles thus promoting safe laboratory working.

Magnetic stir bars in various sizes are also available.

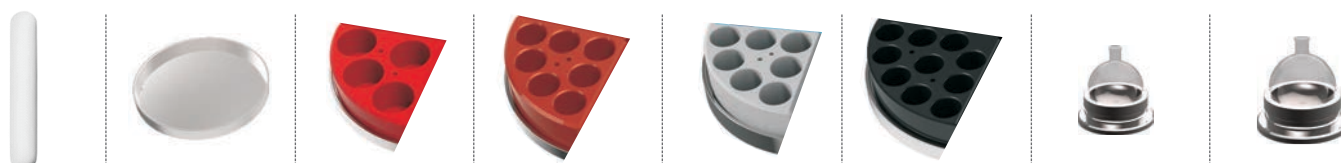

Technical Data & Ordering Information

Model Name	Ordering Code	Pack Size	List Price
Accessory Stir Bar D: 8mm × 25mm	100MSA0BL08025	10	4,400.00
Accessory Stir Bar D: 8mm × 35mm	100MSA0BL08035	10	4,700.00
Accessory Stir Bar D: 12mm × 50mm	100MSA0BL12050	10	13,600.00
Accessory Stir Bar D: 13mm × 60mm	100MSA0BL13060	1	2,000.00
Aluminium Blocks Organiser Carry Plate	BLAHHPA00QP000000	1	5,750.00
Aluminium Quarter Block 4 × 20 ml	BLAHHPA00QB200000	1	4,600.00
Aluminium Quarter Block 4 × 30 ml	BLAHHPA00QB300000	1	7,200.00
Aluminium Quarter Block 7 × 16 ml	BLAHHPA00QB160000	1	5,180.00
Aluminium Quarter Block 10 × 8 ml	BLAHHPA00QB080000	1	5,640.00
Aluminium Quarter Block 12 × 4 ml	BLAHHPA00QB040000	1	5,640.00
Aluminium Reaction Block RB 50 ml	BLAHHPA00RB050000	1	8,510.00
Aluminium Reaction Block RB 100 ml	BLAHHPA00RB100000	1	8,510.00
Aluminium Reaction Block RB 250 ml	BLAHHPA00RB200000	1	8,510.00
Aluminium Reaction Block RB 500 ml	BLAHHPA00RB500000	1	8,510.00
PT1000 Probe	100MHPS01PT100	11	8,668.00
Probe Stand	100MHPS01PS000	1	2,200.00

Heating Mantles

The intelligently designed safe heating mantles provide safety cut off with precise heating along with time & temperature display like never before

Temperature Controlled Heating Mantles

The equipment precisely fits the boiling and distillation flask, round bottom flasks or relevant reaction vessels providing consistent and controllable heating of organic liquids required for the boiling, evaporation, distillation, or extraction process.



Technical Data & Ordering Information

Model Name	GMC250	GMC500	GMC010
Flask Capacity	250 ml	500 ml	1000 ml
Working Temperature Range	Ambient +5 °C to 350 °C		
Temperature Accuracy	1°C		
Timer	upto 999 mins or continuous		
Power Requirements	1Å, 150W	1Å, 200W	1.5Å, 300W
Display	LED Display with Temperature, Time and Process Status		
Top Plate Material	MS	MS	MS
Body Construction	MS	MS	MS
Product Dimensions (L x B x H) mm	310 x 330 x 160	310 x 330 x 160	310 x 330 x 160
Stage wise Heating Modes	Yes	Yes	Yes
External Temperature Probe	PT 100		
HSN Code	84198990		
Ordering Code	BLFHGMC25000000000	BLFHGMC50000000000	BLFHGMC01000000000
Prices / Piece	9,500.00	10,100.00	10,800.00

Technical Data & Ordering Information

Model Name	HMC020	HMC050	HMC011
Flask Capacity	2 L	5 L	10 L
Working Temperature Range	Ambient +5 °C to 350 °C		
Temperature Accuracy	1°C		
Timer	upto 999 mins or continuous		
Power Requirements	2.5Å, 450W	3Å, 600W	6Å, 1200W
Display	LED Display with Temperature, Time and Process Status		
Top Plate Material	SS	SS	SS
Body Construction	MS	MS	MS
Product Dimensions (L x B x H) mm	263 x 355 x 136	320 x 320 x 260	450 x 603 x 215
Stage wise Heating Modes	Yes	Yes	Yes
External Temperature Probe	PT 100		
HSN Code	84198990		
Ordering Code	BLFHMC02000000000	BLFHMC05000000000	BLFHMC01100000000
Prices / Piece	31,400.00	43,800.00	84,300.00

Heating Mantles

Ideal for busy laboratories with multiple users or experiments needing different set temperatures at the same time

Multiposition Heating Mantles

The equipment precisely fits the boiling and distillation flask, round bottom flasks or relevant reaction vessels providing consistent and controllable heating of organic liquids required for the boiling, evaporation, distillation, or extraction process.



Technical Data & Ordering Information

Model Name	MPM062	MPM065
Heating Position	6	6
Max Flask Capacity	250 ml	500 ml
Temperature Range	Ambient +5°C to 350°C	Ambient +5°C to 350°C
Temperature Control	PID with digital energy regulator	PID with digital energy regulator
Temperature feedback	Yes	Yes
Temperature Accuracy	1 °C	1 °C
Display Timer	0 - 999 min and Infinite	0 - 999 min and Infinite
Material of Construction	M.S Powder coated body with SS304 Top Plate	M.S Powder coated body with SS304 Top Plate
Unit Dimensions (L × B × H) mm	1000 × 330 × 135	1000 × 330 × 135
HSN Code	84198990	84198990
Ordering Code	BLFHMPM06200000000	BLFHMPM06500000000
Prices / Piece	69,600.00	69,600.00

Precision Heating Mantles

The intelligently designed safe heating mantles provide safety cutoff with precise heating & stirring features

Precise Stirring & Heating Mantles

The equipment precisely fits the boiling and distillation flask, round bottom flasks or relevant reaction vessels providing consistent and controllable heating of organic liquids required for the boiling, evaporation, distillation, or extraction process.



Technical Data & Ordering Information

Model Name	PRM250	PRM500	PRM010	PRM020
Flask Capacity	250 ml	500 ml	1L	2 L
Working Temperature Range	Ambient +5 °C to 350°C			
Temperature Accuracy	1 °C			
Timer	upto 999 mins or continuous			
Stirring Speed	300 - 2200 rpm			
Power Requirements	1Å, 150W	1Å, 200W	1Å, 200W	2.5Å, 450W
Display	LED Display with Temperature, Time and Process Status			
Top Plate Material	SS	SS	SS	SS
Body Construction	SS	SS	SS	SS
Product Dimensions (L × B × H) mm	310 × 330 × 160	310 × 330 × 160	310 × 330 × 160	263 × 355 × 136
Stage wise Heating Modes	Yes	Yes	Yes	Yes
External Temperature Probe	PT 100			
HSNCode	84198990			
Ordering Code	BLFHPRM 25000000000	BLFHPRM 50000000000	BLFHPRM 01000000000	BLFHPRM 02000000000
Prices / Piece	26,040.00	27,200.00	33,200.00	35,070.00

*PRM Capacities 5L & 10 L available on request

Mini Lab Reactor

Mini Lab Reactor is available with a multi-neck round bottom flask, optimized for academic and research applications. It is a cost-effective solution that includes an oil bath-based heating that eliminates the need for an external heating system. We provide electronic control for temperature, speed, time, and step reaction. We provide optional cooling to prevent reaction runaway in case of an exothermic reaction. We supply explosion-proof variants for critical applications on special request.



- SS Body Oil bath with Drain Valve
- Non Sparking stirrer Drive
- Effortless height Adjustment
- SS Body Oil bath with Drain Valve

This series reactors is the ideal instrument in experiments and manufacturing of modern chemistry, fine chemical engineering, bio-pharmaceuticals and new material synthesis.

Technical Data & Ordering Information

Model Name	MLR250	MLR500	MLR010
RB Reactor Capacity	250ml	500ml	1000ml
Number of Necks*	1CN, 4SN		
Heating Bath Volume	5L		
Temperature Range#	-10°C to 200°C		
Condenser	Double Coil Condenser		
Feed Funnel	Pressure Equalizing		
Receiver Vessel	500ml with Round bottom		
Temperature sensor with glass thermovalve	Yes	Yes	Yes
Hot Bath Drain	Yes (SS)		
Absolute mBar(Pressure)	100-1000 mBar	100-1000 mBar	100-1000 mBar
Vaccum mBar	100-1000ml	100-1000ml	100-1000ml
Stirring Speed(rpm)	50-1000rpm		
impeller	PTFE coated centrifugal	PTFE coated centrifugal	PTFE coated centrifugal
Stirring Power	24W	24W	24W
Agitator	Centrifugal desgin BLDC, SS304 coated with reinforced PTEE Shaft Dia8mm X350mm Ht		
Power	1kW, 230V 50Hz		
Control Unit	Temperature / RPM control Unit with LED Display		
7 seg digital LED controller	YES		
Dimension of Unit MLR	470 × 300 × 750 mm		
Product Codes	BLFHMLR25000000000	BLFHMLR50000000000	BLFHMLR01000000000
HSN	84198990		

* RB Standard Neck sizes Applicable

For Exothermic Recations below RT - External Chiller Needs to be attached. See our Chiller Range

Recirculating Chillers

Labquest state-of-the-art Chillers ensure accurate and constant conditions of instruments even in the challenging laboratory conditions. Recirculating chillers offer multiple benefits, including reducing user costs, protecting the environment, improving reaction reproducibility.



Cooling & Heating Circulators

Routine laboratory applications involving rotary evaporators, soxhlet & lab distillations, jacketed reactors, solvent tanks, Warming reagents, coliform determinations, sample thawing, bacteriological examinations, microbiological assays, cell cultivation, vacuum systems, and even analytical instruments.

Recirculating Chiller

Technical Data & Ordering Information

Model Name	CHL175	CHL500	CHL010	CHL020
Tank capacity	5 L	7.5 L	10 L	20L
Tank size (L × B × H) mm	325 × 176 × 150	325 × 265 × 150	325 × 265 × 200	375X300X250
Overall Dimensions (L × B × H) mm	508 × 257 × 596	594 × 327 × 596	594 × 396 × 723	700X550X700
Cooling capacity	175 W	500 W	1000 W	2000W
Pump flow rate	12.5 LPM	12.5 LPM	12.15 LPM	15LPM
Display	LED	LED	LED	LED
Temperature stability	± 1.0 °C	± 1.0 °C	± 1.0 °C	± 1.0 °C
Temperature range	-10 °C to ambient -5 °C	-10 °C to ambient -5 °C	-10 °C to ambient -5 °C	-10 °C to ambient -5 °C
Castor Wheels for Mobility	NA	Yes	Yes	Yes
HSN Code	84798999			
Ordering Code	BLFRCHL17500000000	BLFRCHL50000000000	BLFRCHL01000000000	BLFRCHL02000000000
Prices / Piece	On Request	On Request	On Request	On Request

Recirculating Heater / Chiller

Technical Data & Ordering Information

Model Name	CTR175	CTR500	CTR010
Tank capacity	5 L	7.5 L	10 L
Tank size (L × B × H) mm	325 × 176 × 150	325 × 265 × 150	325 × 265 × 200
Overall Dimensions (L × B × H) mm	508 × 257 × 596	594 × 327 × 596	594 × 396 × 723
Cooling capacity	175 W	500 W	1000 W
Pump flow rate	12.5 LPM	12.5 LPM	12.5 LPM
Heater Capacity	1200 W	1200 W	1200 W
Display	LED	LED	LED
Temperature stability	± 1.0 °C	± 1.0 °C	± 1.0 °C
Temperature range	-10 °C to ambient -5 °C	-10 °C to ambient -5 °C	-10 °C to ambient -5 °C
Castor Wheels for Mobility	NA	YES	YES
HSN Code	84798999		
Ordering Code	BLFRCTR17500000000	BLFRCTR50000000000	BLFRCTR01000000000
Prices / Piece	On Request	On Request	On Request

Vacuum Pump (Oil-free) NEW PRODUCT

- Boro-017 Vacuum pump is a piston-powered, oil-free pump. With innovative electronic, mechanical technology and human design concept make, compact and light weight, clean and maintenance free, safe and comfortable.
- Driven by Piston, without the need of lubricant, regular oil changes and maintenance; with no oil pollution.
- Equipped with filter cartridge in air inlet to filter particle and moisture to prolong the life of pump.
- Motor has a built-in thermal protection device to shut off the pump automatically when overheated and then resume working when the temperature cools down.

Suitable for



BORO017
Single Position Manifold



BORO034
Three Position manifold



BORO060
Six Position manifold

Technical Data & Ordering Information

Model Name	BORO - 017	BORO034	BORO060
Power (V / Hz)	220 / 50	220 / 50	220 / 50
Max. Vacuum	100 mbar	100 mbar	100 mbar
Max. flow rate	17 L / min	34 L / min	60 L / min
Motor rotation	1450 rpm	1450 rpm	1450 rpm
Outlet Port thread	9 mm	9 mm	9 mm
Vacuum Stage	Single	Double	Double
Suitable for Filtration	Single Station Manifold	3 Position manifold	6 Position manifold
Noise level	50 dB	60 dB	52 dB
Weight	4.4 kg	5.4 kg	8.6 kg
Dimension (W × D × H) mm	(272 × 142 × 165)	310 × 152 × 165	340 × 155 × 195
Electrical Requirement	0.3 A	0.4	1
Power Consumption	65 W	80	190
Ordering Information	100VP300017	100VP400034	100VP600060
HSN Code	84798200	84798200	84798200
Prices / Piece	32,600.00	52,500.00	65,000.00

* Note Caution - Oil Free Series -Never pump toxic, explosive, flammable, corrosive gases, chemicals, solvents or powders. Flowing substances, explosion or fire can cause bodily injury. Install the pump in an area without explosive or flammable substances.

Accessories

Description	Ordering Code
Vacuum Suction Bottle* To maintain an inert environment by removing air or gases from the reaction vessel.	100VPSB0020

*Connecting a vacuum suction bottle in case of oilfree pump filtrations helps protect the pump's components by preventing any liquid or solid material from entering the pump during the filtration process. Thus it ensures higher lifespan for Pump.

Chemical resistance vacuum Pump

The construction with PTFE makes them very resistant to chemical vapors from inlet to exhaust and very tolerant to condensates. Pumping chambers are hermetical ensuring long lifetimes of mechanical parts. Most importantly, diaphragm pumps are oil-free, with vastly reduced service demands compared with oil sealed pumps. They eliminate the cost of water and its contamination well-known from water-jet aspirators and the waste-oil disposal of rotary vane pumps. They are chemical resistant diaphragm vacuum pumps which can be widely used for hard acidic, basic and solvent vapors by utilizing corrosion proof PTFE on all the wetted surfaces.

- High chemical resistant
- Long-term durable
- No air pollution, maintenance free
- Smooth surfaces for easy cleaning
- Sealing system provides reduced leakage rates for improved ultimate vacuum
- Quiet and low vibration
- Thermal protection device



BORO CR C300



BORO CR C400

Technical Data & Ordering Information

Model Name	BORO CR C300	BORO CR C400
Power (V / Hz)	220V / 50Hz	220V / 50Hz
Max. Vacuum	101 mbar	120 mbar
Max. flow rate	22 L / min	34 L / min
Motor rotation	1450 rpm	1450 rpm
Outlet Port thread	10 mm	10 mm
Vacuum Stage	Single	Single
Noise level	50 dB	50 dB
Weight	6 kg	8.5 kg
Dimension (W × D × H)	233 × 110 × 210	294 × 156 × 195
Electrical Requirement	0.5	0.5
Power Consumption	60	95
Ordering Information	100VPC30022	100VPC40034
Prices / Piece	On Request	On Request

Glass Dryer

Labquest dryer offers basic solutions of quick drying laboratory glasswares at 60 °C

Labquest Glass dryers can be used as bench top model or wall hanging in your laboratory washing area. It offers drying of laboratory articles in 10 to 15 minutes. Useful for quick drying viz. GCMS glasswares, Kjeldahl digestion tubes, routine work involving assorted glassware, general purpose drying.



Technical Data & Ordering Information

Model Name	GDS020
Number of Pegs	21
16 mm	8 Nos
10 mm	8 Nos
7 mm	5 Nos
Temperature Range	Ambient to 70°C
Time Control	Yes
Drying Power	650 W
Dimension (L × B × H) in mm	440 × 170 × 550
Voltage (V)	240 V
HSN Code	84798200
Ordering Code	BLFGGDS02000000000
Prices / Piece	23,900.00

Micro Centrifuge

Smart, Sturdy & Silent intelligently designed micro centrifuge built to make your life easier in lab

MCF08VT

With insights gleaned from extensive user-research, Borosil's MCF08VT is everything that a user could want. From reliable performance and high-quality components to intelligently designed chassis and user-friendly interface, MCF08VT is built to make your life easier in the lab.



Technical Data & Ordering Information

Model Name	MCF08VT
Rotor position	8 × 1.5/2.0 ml Microtubes
Tube capacity in ml	1.5 / 2.0 / 0.2 / 0.5
Max speed (rpm)	1000 - 6000 rpm in 100rpm steps
RCF (g)	2000g
Display	Digital
Noise level	< 55 db
Imbalance detection	Yes
Timer	1 - 25 Minutes & infinite mode
Dimension (L × W × H) mm	162 × 157 × 116
Weight	1.1 Kg (with rotor)
Rotors and Adaptors (included in standard pack)	8 × 1.5/2.0 ml Closed Rotor, PCR strip Rotator (2 × 8 × 0.2 m) Reduction adaptors for 0.2 / 0.5ml Microtubes
HSN Code	84211999
Ordering Code	100MCF00800VT0
Prices / Piece	14,440.00

8 x 1.5/2ml rotor



PCR strip rotor



0.2/0.5ml tube reducers



Micro Centrifuge

Smart, Sturdy & Silent intelligently designed micro centrifuge built to make your life easier in lab

MCF12VT

Delivering top-notch accuracy in every cycle despite high load, MCF12VT has been designed keeping in mind the requirements of the clients. The lightning fast 15000 RPM microprocessor controlled centrifuge can perform at peak efficiency and give the desired results. It gives smooth and silent operation even at the maximum speed.









Technical Data & Ordering Information

Model Name	MCF12VT
Rotor position	12 × 1.5ml / 2.0ml Microtubes
Tube capacity in ml	1.5 / 2.0 / 0.5 / 0.4 / 0.2
Max speed (rpm)	15000 rpm
RCF (g)	15596g
Display	Large digital display
Motor Type	Brushless DC motor
Noise level	< 60 db
Imbalance detection	Yes
Timer	Countdown timer : 1 - 99 Mins & infinite mode
Dimension (L × W × H) mm	187 × 265 × 115
Weight	2.2 Kgs (with rotor)
Rotors and Adaptors (included in standard pack)	12 × 1.5/2 ml Angel Rotor, Reduction adaptor for 0.2ml Microtubes Reduction adaptor for 0.4ml / 0.5ml Microtubes
HSN Code	84211999
Ordering Code	100MCF01200VT0
Prices / Piece	54,870.00

Optional Accessories

Description	Ordering Code	Prices / Piece
12 × 1.5/2 ml Angle Rotor	10000MC1202MLF	10,240.00
PCR Strip Rotor (2 × 8 × 0.2 ml)	10000MC0208MLS	16,740.00

12 tubes rotor angle	1.5/2.0ml tubes		0.5ml Adaptor		0.1/0.2ml Adaptor
					
	1.5/2 ml	0.5 ml	0.4 ml	0.2 ml	0.1 ml
Max. Speed	15000	15000	15000	15000	15000
Max. RCF	15596	12577	12074	11105	10278

PCR strip rotor (Optional)	0.1/0.2ml PCR strip
	
Max. Speed	15000
Max. RCF	13080

Micro Centrifuge **NEW PRODUCT**

A resilient micro centrifuge meticulously designed to ensure seamless centrifugation with each rotation.

MCF24VT

The MCF24VT, a 24-place rotor centrifuge, attains speeds up to 17040g, featuring a thoughtfully designed low loading height. Crafted after extensive customer research, it is ideal for clinical, molecular, and bacteriological applications.



Technical Data & Ordering Information

Product code	MCF24VT
Rotar Position	24 × 1.5/2ml microtube
Tube capacity in ml	0.1/0.2/1.5/2.0
Max speed (rpm)	500-13400 RPM in steps of 100 RPM
RCF	17040g
Display	Large digital display
Motor Type	Brushless DC motor
Lid Lock Safety	Yes
Noise level	<60dB
Imbalance detection	Yes
Timer	1 to 999 mins & infinite mode
Dimension (L × W × H) mm	381 × 480 × 185
Weight	8.2 kg (without rotor)
Rotors and Adapters (Included in standard pack)	24 × 1.5/ 2ml microtube rotor Reduction adapter for 0.1/0.2/0.5 ml microtubes.
HSN Code	8421999
Ordering Code	100MCF00240VT0
Prices / Piece	81,900.00

24 x 1.5/2ml



0.2/0.5ml tube reducers



Cooling High Speed Micro Centrifuge

Unmatched performance, safety with preset features for quick cooling



Technical Data & Ordering Information

Model Name	CLMC24VT
Cooling temperature	Up to -20°C
Max speed (rpm)	500 - 15000 rpm
Programmable Feature	User can set and save up to 99 user defined programs of 4 lines each
Display	Large back lit LCD display
Motor Type	Brushless DC motor
Lid Lock Safety	Yes
Imbalance detection	Yes
Timer Setting	30 secs to 999 mins & infinite mode
Dimension (L × W × H) in mm	452 × 314 × 278
Weight	Approx. 43 kgs
HSN Code	84211999
Ordering Code*	100CLMC2400VT0
Prices / Piece	On Request

* Product is supplied without rotors, add rotors as per your application

Optional Accessories

Description	Ordering Code	Prices / Piece
Microtubes Rotor (24 × 1.5 / 2 ml) (21420 × g)	100CLMC2402MLF	26,460.00
Microtubes Rotor (44 × 1.5 / 2 ml) (22388 × g)	100CLMC4402MLF	35,820.00
Angal Rotor 8 × 5 ml (18461 × g)	100CLMC0805MLF	38,830.00
PCR Strip Rotor (4 × 8 × 0.2 ml) (15397 × g)	100CLMC4802MLS	39,720.00

24 x 2ml rotor (standard supply)	1.5/2.0ml tubes	0.5ml Adaptor	0.1/0.2ml Adaptor	PCR strip rotor (optional)	0.2ml PCR strip	44 x 2ml rotor (optional)	1.5/0.2ml tubes	0.5ml Adaptor	0.1/0.2ml Adaptor	8 x 5ml rotor (optional)	5ml tube
Max. Speed	15000	15000	15000 15000	Max. Speed	15000	Max. Speed	15000	15000	15000 15000	Max. Speed	15000
Max. RCF x g	21420	18842	16103 16930	Max. RCF x g	15397	Max. RCF x g	22388	19810	17070 17898	Max. RCF x g	18461

Clinical Centrifuge

Centrifuge for clinical application are designed to accommodate rotor and blood centrifuge tubes



Technical Data & Ordering Information

Model Name	DCF6VT
Rotor position	6 × 15 ml (Fixed angle)
Tube capacity in ml	2 / 5 / 7 / 15 ml
Max speed (rpm)	6500 rpm + 100 rpm
RCF (g)	3684 g - 6 × 15 ml
Motor Type	Brushless DC motor
Noise level (db)	< 60 db
Lid Lock Safety	Yes
Imbalance detection	Yes
Timer setting	1 - 30 Minutes & infinite mode
Dimension (L × W × H) mm	260 × 244 × 205
Weight	4 Kgs (with rotor)
Rotors and Adaptors (included in standard pack)	6 × 15ml rotor (Fixed angle) Adaptor for 2ml/5ml/7ml Blood collection tube
HSN Code	84211999
Ordering Code*	100DCF00600VT0
Prices / Piece	51,820.00

* Also available in 8 × 15 ml fixed angle rotor (3873g) Part No. 100DCF00800VT0

Optional Accessories

Description	Ordering Code	Prices / Piece
Fixed angle rotor, 8 × 15 ml (1950g)	100CCFA0815MLF	17,300.00

Clinical Centrifuge **NEW PRODUCT**

Expertly designed Clinical centrifuge for PRP protocols, accommodating wide range of sample sizes while ensuring user protection with motorized safety Latch



Technical Data & Ordering Information

Product code	CCD4000VT
Rotar Position*	6 × 10 ml (swing out rotor), 8 × 15 ml (Fixed angle), 16 × 10 ml (fixed angle)
Tube capacity in ml	10/15 ml
Cooling Temperature	5-40° C
Max speed (rpm)	500 - 4000 RPM in steps of 10 RPM
RCF	2270 g - 6 × 10 ml
Motor Type	BLDC
Lid Lock Safety	Yes
Noise level	≤65 dB
Imbalance detection	Yes
Timer	1 to 999 mins, infinite
Dimension (L × W × H) mm	381 × 480 × 185
Weight	8.2 kg (without rotor)
HSN Code	84211999
Ordering Code	100CCD00400VT0
Price / Piece	60,700.00

*Product is supplied without rotors. Rotors to be added as per application

Accessories

Description	Ordering Code	Max Speed	Max RCF × g	Price
Swing out rotor 6 × 10 ml	100CCD0610MLS	4000	2270 g	6,100.00
Fixed angle rotor 8 × 15 ml	100CCD0815MLF	4000	1950 g	6,100.00
Fixed angle rotor 16 × 10 ml	100CCD1610MLF	4000	2180 g	8,900.00

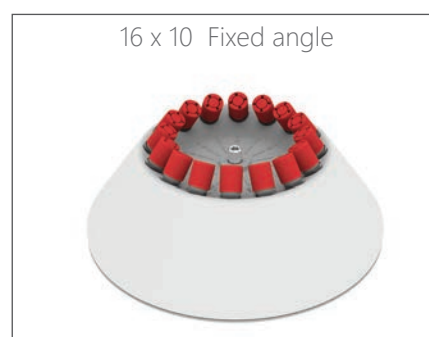
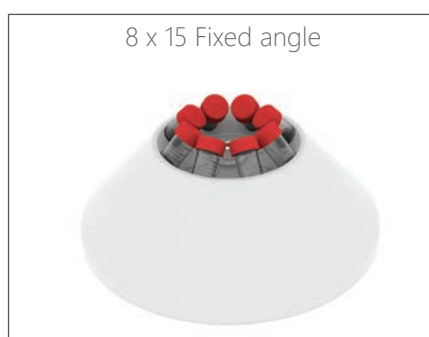
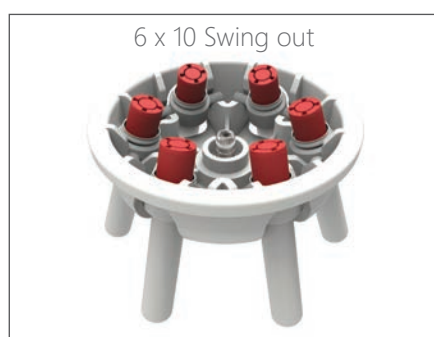

Clinical Centrifuge **NEW PRODUCT**

Optimize your molecular biology work flows with a fixed angle plate clinical centrifuge. Tailored for real-time and end time PCR applications for both skirted and nonskirted PCR plates.



Technical Data & Ordering Information

Product code	CCFA250VT
Rotar capacity*	2 microplate - 96 & 384 wells (Fixed Angle)
Maximum RPM/RCF(g)	2500 RPM / 462 g
Motor Type	Brushless DC motor
Speed setting	500 - 2500 RPM in steps of 100 RPM
Timer setting	1 - 99 mins & infinite mode
Lid Lock Safety	Yes
Noise Level	<65 dB
Programmable feature	User can set & save P1 & P2 user defined programs (protocol)
Dimensions (L x W x H)	330 x 265 x 161 mm
Voltage / Consumption	24 W
Weight	4.0 kgs
HSN Code	84211999
Ordering Code	100CCFA0250VT0
Price / Piece	27,600.00

*Rotor supplied as standard accessory



Clinical Centrifuge **NEW PRODUCT**

Clinical Centrifuge crafted for hematocrit application. The innovative HCT rotor combined with a screw on top lid, not only enhances operational ease but also provides superior protection against contamination.



Technical Data & Ordering Information

Product code	CCH120VT
Rotar capacity*	24 × up to 75 mm length capillary tubes
Maximum RPM/RCF(g)	12000 RPM / 14118 g
Motor Type	Brushless DC motor
Speed setting	500-12000 RPM in steps of 100 RPM
Timer setting	Upto 12 mins
Lid Lock Safety	Yes
Rotor	HCT Rotor with screw on lid
Programmable feature	User can set parameters beforehand
Dimensions (L × W × H)	330 × 265 × 161 mm
Voltage / Consumption	24 V 5.6A / 132W
Weight	4.5 Kgs
HSN Code	84211999
Ordering Code	100CCH12000VT0
Price / Piece	65,800.00

*Rotor & Reader supplied as standard accessory

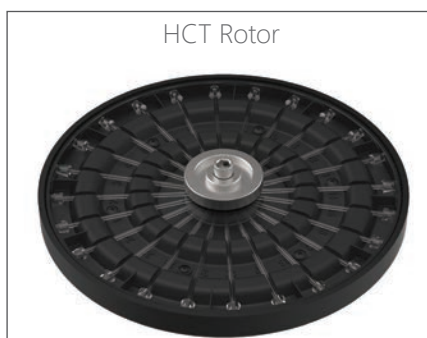

Clinical Centrifuge



Centrifuge for clinical application are designed to accommodate rotor and blood centrifuge tubes



Technical Data & Ordering Information

Model Name	CCD4504VT
Rotor position	Combi Rotor 4 × 50 ml + 4 × 15 ml or 8 × 15 ml
Tube capacity in ml	15 / 50 ml
Max speed (rpm)	4500 rpm
RCF (g)	1985 × g
Motor Type	Brushless DC motor
Noise level (db)	< 60 db
Lid Lock Safety	Yes
Imbalance detection	Yes
Timer setting	1 - 99 Minutes & infinite mode
Dimension (L × W × H) mm	330 × 265 × 161
Weight	4 Kgs
Rotors and Adaptors (included in standard pack)	Combi Rotor 4 × 50 ml + 4 × 15 ml or 8 × 15 ml Adaptor for 5ml, 7ml, 10ml standard blood collection tube
HSN Code	84211999
Ordering Code	100CCD04504VT0
Prices / Piece	33,130.00

Additional Technical Data

Tube Capacity	50ml	15ml	10ml	7ml	5ml
Dimensions (mm)	025 × 115	017 × 120	016 × 100	013 × 100	012 × 75
Radius (mm)	8.77	8.77	8.77	8.37	8.37
Speed (RPM)	4500	4500	4500	4500	4500
Max. RCF	1985	1985	1985	1985	1985
Total no. of tube	4	8	8	8	8
Adaptor Required					
		No	No	Yes	Yes
		No	No	No	Yes
		No	No	No	No

Universal Lab Centrifuge

Designed to provide ideal results with combination rotor with unparalleled safety features



Technical Data & Ordering Information

Model Name	ULC4504VT
Rotor position (max)	4 × 100 ml
Max speed (rpm)	4500 rpm
RCF (g)	g varies as per rotor
Motor Type	Brushless DC motor
Display	Digital
Lid Lock Safety	Yes
Imbalance detection	Yes
Timer Setting	30 sec - 99 mins & infinite mode
Speed Setting	500 to 4500 rpm
Dimension (L × W × H) mm	475 × 585 × 325
Weight	23 Kgs (without rotor)
Rotors (not included)	Multiple rotor options (swing and fixed angle)
HSN Code	84211999
Ordering Code*	100ULC04504VT0
Prices / Piece	76,410.00

Product is supplied without rotors, add rotors as per your application

Optional Accessories

Description	Ordering Code	Max Speed	Max RCF × g	Prices / Piece ₹
Swing Out Rotor 32 × 6ml	100UC1A3206MLS	4500	3164 g	24,900.00
Swing Out Rotor 16 × 15ml	100UC1A1615MLS	4500	3485 g	13,590.00
Swing Out Rotor 12 × 15ml	100UC1A1215MLS	4500	3485 g	12,130.00
Swing Out Rotor 8 × 15ml	100UC1A0815MLS	4500	3340 g	7,650.00
Swing Out Rotor 4 × 50ml	100UC1A0450MLS	4500	3485 g	8,990.00
Swing Out Rotor 4 × 100ml (with lid)	100UC1A0401LMS	4500	3164 g	33,520.00
Swing Out Rotor 2 Micro plates	100UC1A0002MPS	4500	2355 g	37,800.00
Fixed Angle Rotor 16 × 15ml	100UC1A1615MLF	4500	3144 g	12,130.00
Fixed Angle Rotor 12 × 15ml	100UC1A1215MLF	4500	3144 g	10,590.00
Fixed Angle Rotor 6 × 50ml	100UC1A0650MLF	4500	2644 g	8,680.00
Fixed Angle Rotor 4 × 50ml	100UC1A0450MLF	4500	2644 g	8,100.00
Fixed Angle Rotor 4 × 100ml	100UC1A0401MLF	4500	2599 g	16,960.00
Fixed Angle Rotor 24 × 15ml	100UC1A2415MLF	4500	2854 g	20,350.00

Universal Lab Centrifuge

Designed to provide ideal results with combination rotor with unparalleled safety features



Technical Data & Ordering Information

Model Name	ULC4204VT
Rotor position (max)	4 × 250 ml
Max speed (rpm)	4200 rpm
RCF (g)	g varies as per rotor
Motor Type	Brushless DC motor
Display	Digital
Lid Lock Safety	Yes
Imbalance detection	Yes
Timer Setting	30 sec - 99 mins & infinite mode
Speed Setting	500 to 4500 rpm
Dimension (L × W × H) mm	475 × 585 × 325
Weight	23 Kgs (without rotor)
Rotors (not included)	Multiple rotor options (swing and fixed angle)
HSN Code	84211999
Ordering Code*	100ULC04204VT0
Prices / Piece	1,07,090.00

Product is supplied without rotors, add rotors as per your application

Optional Accessories

Description	Ordering Code	Max Speed	Max RCF × g	Prices / Piece ₹
Swing Out Rotor 32 × 6ml	100UC2A3206MLS	4200	2766 g	24,960.00
Swing Out Rotor 16 × 15ml	100UC2A1615MLS	4200	2884 g	13,480.00
Swing Out Rotor 4 × 50ml	100UC2A0450MLS	4200	2884 g	18,840.00
Swing Out Rotor 4 × 100 ml	100UC2A0401MLS	4200	2766 g	17,300.00
Swing Out Rotor 4 × 100ml (with lid)	100UC2A0401LMS	4200	2884 g	30,520.00
Swing Out Rotor 4 × 250 ml	100UC2A0402MLS	4200	3181 g	54,100.00
Swing Out Rotor 64 × 6 ml	100UC2A6406MLS	4200	3181 g	51,870.00
Swing Out Rotor 2 Micro plates	100UC2A0002MPS	4200	2074 g	37,800.00
Fixed Angle Rotor 16 × 15ml	100UC2A1615MLF	4200	2410 g	12,130.00
Fixed Angle Rotor 6 × 50ml	100UC2A0650MLF	4200	2410 g	8,100.00
Fixed Angle Rotor 4 × 50ml	100UC2A0450MLF	4200	2331 g	8,100.00
Fixed Angle Rotor 4 × 100ml	100UC2A0401MLF	4200	2272 g	16,960.00
Fixed Angle Rotor 24 × 15ml	100UC2A2415MLF	4200	2489 g	20,350.00

High Speed Universal Lab Centrifuge

Centrifuge boasts a stainless steel rotor for rapid pelleting and centrifugation with a convenient short spin option. Its intelligent air flow system guarantees precise temperature regulation in the chamber, combining durability and ease of maintenance.



Technical Data & Ordering Information

Model Name	ULC1504VT
Rotar Position (max)	4x100 ml
Max speed (rpm)	500-15000 RPM in steps of 100 RPM
RCF	22388g
Display	Large digital display
Motor Type	Brushless DC motor
Lid Lock Safety	Yes
Noise level	<65dB
Imbalance detection	Yes
Timer	1 to 999 mins 59 secs. & infinite mode
Dimension (L X W X H) mm	475x585x325
Weight	23 kg (without rotor)
HSN Code	84211999
Ordering Code	100ULC1504VT00
Prices / Piece	1,32,900.00

* Product is supplied without rotors. Rotors to be added as per application

Optional Accessories

Description	Ordering Code	Max Speed	Max RCF × g	Prices / Piece ₹
Swing Out Rotor 16 × 15 ml	100UC3A1615MLS	4500	3305 g	20,880.00
Swing Out Rotor 4 × 50 ml	100aUC3A0450MLS	4500	3305 g	17,540.00
Swing Out Rotor 4 × 100 ml	100UC3A0401MLS	4500	3305 g	16,980.00
Swing Out Rotor 2 Micro plates	100UC3A0002MPS	4500	2377 g	36,200.00
Swing Out Rotor 32 × 06 ml	100UC3A3206MLS	4500	3164 g	25,820.00
Swing Out Rotor 4 × 100 ml (with lid)	100UC3A0401LMS	4500	3164 g	29,400.00
Fixed Angle Rotor 16 × 15 ml	100UC3A1615MLF	6000	4910 g	24,960.00
Fixed Angle Rotor 6 × 50 ml	100UC3A0650MLF	6000	4910 g	19,390.00
Fixed Angle Rotor 4 × 50 ml	100UC3A0450MLF	6000	4750 g	17,930.00
Fixed Angle Rotor 24 × 15 ml	100UC3A2415MLF	6000	5070 g	25,200.00
Fixed Angle Rotor 4 × 100 ml	100UC3A0401MLF	6000	4628 g	17,930.00
Fixed Angle Rotor 24 × 2 ml	100UC3A2402MLF	15000	21420 g	30,510.00
Fixed Angle Rotor 44 × 2 ml	100UC3A4402MLF	15000	22388 g	38,290.00
Fixed Angle Rotor 4 × 8 × 0.2 ml PCR	100UC3A4802MLF	15000	15397 g	39,900.00
Fixed Angle Rotor 8 × 5 ml	100UC3A0805MLF	15000	18461 g	35,390.00

Cooling Universal Lab Centrifuge

Multi-rotor configuration with high speed operation and variable temperature range for wide range of lab protocol



Technical Data & Ordering Information

Model Name	CULC1504VT
Rotor position (MAX)	4 × 100 ml (fixed & swing out) / 32 × 6 ml (swing out)
Cooling temperature	Up to - 10°C
Max speed (rpm)	15000 rpm
RCF (g)	g varies as per rotor
Display	Large back lit LCD display
Motor type	Brushless DC motor
Speed setting	500 to 15000 rpm
Lid lock safety	Yes
Imbalance detection	Yes
Timer setting	30 secs. to 999 mins 59 secs. & infinite mode
Dimension (L × W × H) in mm	705 × 585 × 330
Weight	57 kgs (without rotor)
HSN Code	84211999
Ordering Code*	100CULC1504VT0
Prices / Piece	On Request

* Product is supplied without rotors, add rotors as per your application

Optional Accessories

Description	Ordering Code	Max Speed	Max RCF × g	Prices / Piece ₹
Swing Out Rotor 16 × 15 ml	100UC3A1615MLS	4500	3305 g	20,880.00
Swing Out Rotor 4 × 50 ml	100aUC3A0450MLS	4500	3305 g	17,540.00
Swing Out Rotor 4 × 100 ml	100UC3A0401MLS	4500	3305 g	16,980.00
Swing Out Rotor 2 Micro plates	100UC3A0002MPS	4500	2377 g	36,200.00
Swing Out Rotor 32 × 06 ml	100UC3A3206MLS	4500	3164 g	25,820.00
Swing Out Rotor 4 × 100 ml (with lid)	100UC3A0401LMS	4500	3164 g	29,400.00
Fixed Angle Rotor 16 × 15 ml	100UC3A1615MLF	6000	4910 g	24,960.00
Fixed Angle Rotor 6 × 50 ml	100UC3A0650MLF	6000	4910 g	19,390.00
Fixed Angle Rotor 4 × 50 ml	100UC3A0450MLF	6000	4750 g	17,930.00
Fixed Angle Rotor 24 × 15 ml	100UC3A2415MLF	6000	5070 g	25,200.00
Fixed Angle Rotor 4 × 100 ml	100UC3A0401MLF	6000	4628 g	17,930.00
Fixed Angle Rotor 24 × 2 ml	100UC3A2402MLF	15000	21420 g	30,510.00
Fixed Angle Rotor 44 × 2 ml	100UC3A4402MLF	15000	22388 g	38,290.00
Fixed Angle Rotor 4 × 8 × 0.2 ml PCR	100UC3A4802MLF	15000	15397 g	39,900.00
Fixed Angle Rotor 8 × 5 ml	100UC3A0805MLF	15000	18461 g	35,390.00

Dry Baths

LabQuest versatile Dry Bath, offers a wide range of inter changeable blocks to accommodate various tubes and plates



*Representative image Dry Bath LBH010 is supplied without aluminum block

Technical Data & Ordering Information

Model Name	LBH010
Temperature Range	Ambient +5°C to 130°C
Temperature Accuracy	±0.5°C at 37°C
Display Resolution	±0.1°C
Heating Up Time	<18 min 30°C TO 130°C
Process Timer	0 - 999 min
Temperature Control	PID and Digital Energy Regulator
Unit External Dimensions (W × D × H) in mm	285 × 190 × 156
Cover For Dry Block	UV protection
Power consumptions	200W
Current Consumption	1A
HSN Code	841989900
Ordering Code	BLFHLBH01000000000
Prices / Piece	22,680.00

8 well PCR strip of 0.2 ml, 32 wells,
φ6.35mm, depth 19mm
BLAALBHPCR3208W004



For 0.5 ml tube, 24 wells,
φ8.0mm, depth 25mm
BLAALBH0MW2406W004



FOR 2.0 ml or 1.5ml tube 16 wells of,
φ11.0mm, depth 30mm
BLAALBH0MW1604W004



Versatile multi well block for 8 wells of 0.2ml tube, 8 wells of 0.5ml tube, and 8 wells of 2.0ml or 1.5ml tube
BLAALBHVW008W004

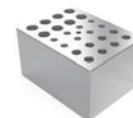

15 ml tube* 12 wells
φ17.3mm, depth 50mm
BLAALBH0MW1204W004



For 50 ml tube* 4 wells,
φ29.2mm, depth 50mm
BLAALBH0MW0402W004

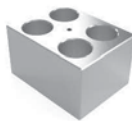

Bead bath or water bath block Vol of 300ml*
BLAALBH0MW000BB004



Flat 96 well* plate block
BLAALBH0MW0096W004



* During usage of 15ml, 50ml & 96 well plate blocks, top covers remains open

Recommended Accessories

Description	Ordering Code	Prices / Piece ₹
LBH010 ALU Block - 8 × 4 Well PCR Strip Tube	BLAALBHPCR3208W004	11,550.00
LBH010 ALU Block - 6 × 4 Well, 0.5 ml Tube	BLAALBH0MW2406W004	11,550.00
LBH010 ALU Block - 4 × 4 Well, 1.5 / 2.0 ml Tube	BLAALBH0MW1604W004	11,550.00
LBH010 ALU Block - Multi Versatile Well - 8 Wells	BLAALBHVW008W004	11,550.00
LBH010 ALU Block - 4 × 3 Well, 15 ml Tube	BLAALBH0MW1204W004	11,550.00
LBH010 ALU Block - 2 × 2 Well, 50 ml Tube	BLAALBH0MW0402W004	11,550.00
LBH010 ALU Bead Bath / Water bath block (w/o beads)	BLAALBH0MW000BB004	15,440.00
LBH010 ALU FLAT 96 well plate block	BLAALBH0MW0096W004	17,640.00

Incubator

Cooling Incubator with versatile performance

- Compact design for small bench space
- Accommodates flask sizes upto 2L
- Internal power outlet for easy installation of small shakers mixers etc.



Technical Data & Ordering Information

Model Name	INCH0025
Temperature Range	Ambient less 15 °C to 60 °C
Temperature Accuracy	0.5 °C (at 37 °C)
Temperature Uniformity	± 1.5 °C (at 37 °C)
Temperature Increments	± 1°C
Dimensions (L × W × H) in mm	337 × 370 × 475
Capacity	25L
Weight	6.5 kgs
Power Consumption	240V
HSN Code	84198990
Ordering Code	100INCH0025000
Prices / Piece	73,050.00

Orbital Shaker

Maintenance free brushless DC motor for powerful performance under high speed



Technical Data & Ordering Information

Model Name	PL ONE
Type of movement	Orbital
Orbital diameter in mm	2 mm
Number of plates	1
Motor Type	Brushless DC motor
Speed range in rpm	300 RPM to 1800 RPM
Run Time	1 to 99 mins & infinite
Pulse mode	No
Maximum Volume	96 / 384 well plate
Inbuilt Counter balance	Yes
Dimensions (W × D × H)	85 × 127 × 86 mm
Digital Display	Yes
Attachments (included in standard pack)	Replaceable Clamps Form attachment for 20 microtube
HSN Code	84798200
Ordering Code	100PL000100000
Prices / Piece	18,200.00

High Capacity Orbital Shaker

Platform Shaker with true orbital & linear reciprocating motion



Technical Data & Ordering Information

Model Name	7500S
Type of movement	Orbital / Linear
Orbital diameter in mm	10
Speed range in rpm	50-500 rpm
Motor type	BLDC
Display	Digital
Run time	1 min to 99.59 hrs
Programable feature	6 programs with each program having 9 sub-programs
Program Looping	Yes
Platform Size (L × W) in mm	330 × 330
Dimensions (W × D × H) in mm	350 × 408 × 99
HSN Code	84798200
Ordering Code	100S0000075000
Prices / Piece	90,970.00

Optional Accessoried - For Shaker 7.5 Kg

Description	Ordering Code	Prices / Piece ₹
Universal platform with adjustable bars (Flask capacity 9 × 250 ml, 6 × 500 ml)	100S00009UPB75	9,960.00
Base plate with 9 plastic clamps : 9 × 250 ml	100S02509BPP75	9,930.00
Base plate with 9 plastic clamps : 9 × 500 ml	100S05009BPP75	10,700.00
Base plate with 9 Stainless steel clamps : 9 × 100 ml	100S01009BPS75	12,130.00
Base plate with 9 Stainless steel clamps : 9 × 250 ml	100S02509BPS75	12,500.00
Base plate with 9 Stainless steel clamps : 9 × 500 ml	100S05009BPS75	15,050.00
Stainless steel Clamp for 100 ml flask	100S01001SSC00	780.00
Stainless steel Clamp for 150 ml flask	100S01501SSC00	780.00
Stainless steel Clamp for 250 ml flask	100S02501SSC00	780.00
Stainless steel Clamp for 500 ml flask	100S05001SSC00	1,440.00
Stainless steel Clamp for 1000 ml flask	100S10001SSC00	2,780.00
Funnel Attachment	100S00000FA075	12,870.00

High Capacity Orbital Shaker

Platform Shaker with true orbital & linear reciprocating motion



Technical Data & Ordering Information

Model Name	15000S	
Type of movement	Orbital / Linear	
Orbital diameter in mm	30, 40, 50	60, 70
Speed range in rpm	50 - 300 rpm	50 - 200 rpm
Motor type	BLDC	
Display	Digital	
Run time	1 min to 99.59 hrs	
Programable feature	6 Programs with each program having 9 subdivision	
Program Looping	Yes	
Platform Size (L × W) in mm	745 × 490	
Dimensions (W × D × H) in mm	625 × 825 × 165	
HSN Code	84798200	
Ordering Code	100S0000150000	
Prices / Piece	On Request	

Optional Accessoried - For Shaker 7.5 Kg

Description	Ordering Code	Prices / Piece ₹
Universal Platform for 44 × 100 ml, 36 × 250 ml, 25 × 500 ml, 13 × 1000 ml	100S00UP150000	54,140.00
Base Plate for Plastic Clamps for 24 × 250 ml, 24 × 250 ml	100S0BPC150015	35,840.00
Plastic Clamp 1 No 250 ml	100S02501PC015	970.00
Plastic Clamp 1 No 500 ml	100S05001PC015	1,220.00
Base Plate for SS Clamps 24 × 100 ml, 24 × 150 ml, 24 × 250 ml	100S0BSC250015	32,200.00
SS Clamp 1 No, 100 ml	100S01001SC015	1,230.00
SS Clamp 1 No, 150 ml	100S01501SC015	1,510.00
SS Clamp 1 No, 250 ml	100S02501SC015	1,510.00
Base Plate for SS Clamps 24 × 500 ml, 8 × 1000 ml	100S0BSC100015	32,200.00
SS Clamp 1 No 500 ml	100S05001SC015	2,100.00
SS Clamp 1 No 1000 ml	100S10001SC015	2,430.00

Orbital Shaker

Maintenance free brushless
DC motor for powerful performance
under high speed



Technical Data & Ordering Information

Model Name	PL FOUR
Type of movement	Orbital
Orbital diameter in mm	3 mm
Number of plates	4
Motor Type	Brushless DC motor
Speed range in rpm	200 RPM to 1200 RPM
Run Time	1 to 999 mins & infinite
Pulse mode	Yes
Maximum Volume	4 × 96 / 384 well plate
Inbuilt Counter balance	Yes
Dimensions (W × D × H)	343 × 88 × 195 mm
Digital Display	Yes
Attachments (included in standard pack)	NA
HSN Code	84798200
Ordering Code	100PL000400000
Prices / Piece	37,050.00

Vortexers







The compact and new-age designed vortex mixer is capable of meeting the mixing requirements of laboratory



Technical Data & Ordering Information

Model Name	BHRMI 1.0
Speed	Up to 2800 rpm
Orbital diameter	6 mm
Motor type	AC motor
Operational mode	Touch, Stand-by & Continuous mode
Feet	Four suction cups
Unit External Dimension (W × D × H) in mm	132 × 160 × 180
Power consumption	55 W
Current consumption	1 A
HSN Code	84798200
Ordering Code	BLFHVMX01000000000
Prices / Piece	10,500.00

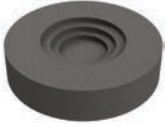
Optional Accessories for BHRMI 1.0

<p>Accessories for 96 (Well Plates) Ordering code (Combine) BLAHVMX02060000000</p>  <p>Microplate holder</p>  <p>Well plate locking belt</p>	<p>Accessories for (volumetric Flask) Ordering code (Combine) BLA0EVA000FOAM0VMX</p>  <p>25, 50, 100ml Volumetric Flask Belt</p>  <p>Volumetric Flask Belt Locker</p>  <p>Volumetric flask Base foam</p>  <p>Foam Holder</p>
--	--

Description	Ordering code	Accessories 1.0
Rubber Cup	BLAHVMX01040000000	Included
Flat Foam	BLAHVMX01050000000	
Vial Holder	BLAHVMX01000000001	
Foam Holder	BLAHVMX01010000007	
EVA Vial Holder foam	BLAHVMX02060000000	Optional
Attachment Volumetric Flask	BLA0EVA000FOAM0VMX	

Vortexers





The compact and new-age designed vortex mixer is capable of meeting the mixing requirements of Laboratory



Technical Data & Ordering Information

Model Name	BHRMI 2.0
Speed	Upto 2800 rpm
Orbital diameter	6 mm
Motor type	BLDC motor
Operational mode	Touch, Stand-by & Continuous mode
Timer Setting	0 - 999 min
Display	LED with timer
Feet	Four suction cups
Unit External Dimension (W × D × H) in mm	132 × 160 × 180
Power consumption	56 W
Current consumption	1.5 A
HSN Code	84798200
Ordering Code	BLFHVMX02000000000
Prices / Piece	14,400.00

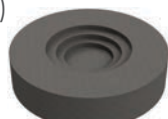
Optional Accessories for BHRMI 1.0

Accessories for 96 (Well Plates) Ordering code (Combine) BLAHVMX02060000000		Accessories for (volumetric Flask) Ordering code (Combine) BLA0EVA000FOAM0VMX	
 Microplate holder	 Well plate locking belt	 25, 50, 100ml Volumetric Flask Belt	 Volumetric flask Base foam
		 Volumetric Flask Belt Locker	 Foam Holder

Description	Ordering Code	Accessories 2.0
Rubber Cup	BLAHVMX01040000000	Included
Flat Foam	BLAHVMX01050000000	
Vial Holder	BLAHVMX01000000001	
Foam Holder	BLAHVMX01010000007	
EVA Vial Holder foam	BLAHVMX02060000000	Optional
Attachment Volumetric Flask	BLA0EVA000FOAM0VMX	

Multitube Vortexer

Engineered for cell lysis, mixing suspensions and general sample agitation



Technical Data & Ordering Information

Model Name	MTV012
Orbital Diameter in mm	6
Speed range (rpm)	50 - 2200 rpm
Motor type	BLDC motor
Speed Accuracy	±50 rpm
Operation Mode	Pulse & Continuous mode
Maximum Load	4.0 Kg
Digital time setting	1 min - 999 min & Infinite
Dimensions in mm	450 × 245 × 475
Weight (Kg)	24 Kg
Power	60W
Power Supply	AC 100-240V, 50/60Hz
	Foam insert for 07ml × 60 Tubes / Foam insert for 15ml × 45 Tubes
	Foam insert for 50ml × 18 Tubes
HSN Code	84798200
Ordering Code	BLFHMTV01200000000
Prices / Piece	On Request

Optional Accessories for Multitube Vortexer



Description	Ordering Code	Prices / Piece ₹
50ML TUBE HOLDING FOAM	BLA0FOAMMTV0000003	3,310.00
15ML TUBE HOLDING FOAM	BLA0FOAMMTV0000004	3,310.00
7ML TUBE HOLDING FOAM	BLA0FOAMMTV0000005	3,310.00
250ml CONICAL FLASK HOLDING FOAM*	BLA0FOAMMTV0000006	3,310.00
100ml VOLUMETRIC FLASK HOLDING FOAM*	BLA0FOAMMTV0000007	3,310.00

Bottle Top Dispensers

Great Sample Preparations are made easy by Lab Essentials Dispensers

- Splash safety guard
- Hybrid valve for smooth operation
- Easy calibration reset
- QR code for chemical compatibility chart



Technical Data & Ordering Information

Product Code RESEARCH Without Recirculation	Volume Range (ml)	Increment (ml)	Accuracy		CV		Prices / Piece ₹
			± %	± ml	± %	± ml	
BLFLLH002011002D00	0.25 - 2.5	0.05	0.6	0.012	0.2	0.004	15,000.00
BLFLLH002011005D00	0.5 - 5.0	0.1	0.6	0.03	0.2	0.01	15,000.00
BLFLLH002011016D00	1.0 - 10.0	0.2	0.6	0.06	0.2	0.02	15,000.00
BLFLLH002011020D00	2.5 - 25.0	0.5	0.6	0.18	0.2	0.06	21,700.00
BLFLLH002011040D00	5.0 - 50.0	1	0.6	0.36	0.2	0.12	21,700.00
BLFLLH002011100D00	10.0 - 100.0	2	0.6	0.6	0.2	0.2	25,900.00

Product Code PINNACLE With Recirculation	Volume Range (ml)	Increment (ml)	Accuracy		CV		Prices / Piece ₹
			+ %	+ ml	+ %	+ ml	
BLFLLH002012002D00	0.25 - 2.5	0.05	0.6	0.012	0.2	0.004	24,900.00
BLFLLH002012005D00	0.5 - 5.0	0.1	0.6	0.03	0.2	0.01	24,900.00
BLFLLH002012016D00	1.0 - 10.0	0.2	0.6	0.06	0.2	0.02	24,900.00
BLFLLH002012020D00	2.5 - 25.0	0.5	0.6	0.18	0.2	0.06	33,100.00
BLFLLH002012040D00	5.0 - 50.0	1	0.6	0.36	0.2	0.12	35,300.00
BLFLLH002012100D00	10.0 - 100.0	2	0.6	0.6	0.2	0.2	50,900.00



e-Titrate

An ergonomically designed digital burette: a perfect solution for Industrial Titration, Environmental and analytical testing, and pharmaceutical analysis.

- Fine adjustment wheel for determining accurate end point
- 2 in 1 instrument for Dosing and Titration
- Built in Calibration mode for liquids of different viscosities
- Moving Cannula for purging and drip free titration
- Complies with DIN ISO 8655-3 Standard
- Memory function allowing storage of 1000 readings

Note : Data could be transferred in PC through RS232 or USB cable using Titrexsoft software as optional Accessory.



Technical Data & Ordering Information

Product code	DB050
Capacity (ml)	0- 50 ml
Display Increment (ml)	0.01
Accuracy in +- %	0.06%
Accuracy in +- ml	0.03
CV in +- %	0.02%
CV in +- ml	0.01
HSN Code	90278090
Ordering Code	LH00201401200FA000
Prices / Piece	1,18,000.00

Accessories

Description	Ordering Code	price
software along with RS232/ USB Cable	LH002014012FAACC01	On Request

e- Dispenser **NEW PRODUCT**

Introducing the next evolution in lab equipment – our Dispenser plus titrator. Seamlessly transition from sample preparation to testing with unparalleled precision and versatility.

- Dual functionality: One Instrument for dispensing and titration
- 3 calibrated preset speed
- In built calibration features allowing highest accuracy
- USB interface for data transfer



Technical Data & Ordering Information

Product code	EHD050
Capacity (ml)	0- 50 ml
Dispense Display Increment (ml)	0.2
Titration Display Increment (ml)	0.01
Accuracy in +- %	0.10%
Accuracy in +- ml	0.05
CV in +- %	0.05%
CV in +- ml	0.025
HSN Code	90278090
Ordering Code	BLFLLH002014012E00
Prices / Piece	On Request

Micropipettes

C1 Designed to take manual liquid-handling workflows to a whole new level with industry-leading accuracy and precision.

- Silicone Oring for optimal tip seal
- Robust design includes metal tip base
- Low operating thumb force



Technical Data & Ordering Information - Fixed volume

Model Name	Volume Range (µl)	Inaccuracy (%)	Imprecision (%)	Prices / Piece ₹
LHC17111001	1	2.5	1.8	15,750.00
LHC17111002	2	2.5	1.8	15,750.00
LHC17111005	5	1.2	0.8	15,750.00
LHC17111006	10	1.0	0.5	15,750.00
LHC17111008	20	1.0	0.3	15,750.00
LHC17111009	25	0.8	0.4	15,750.00
LHC17111010	30	1.2	0.4	15,750.00
LHC17111012	50	1.0	0.3	15,750.00
LHC17111016	100	0.7	0.2	15,750.00
LHC17111020	200	0.6	0.2	15,750.00
LHC17111021	250	2.0	0.6	15,750.00
LHC17111024	500	0.8	0.2	15,750.00
LHC17111029	1000	0.8	0.2	15,750.00
LHC17111030	2000	1.2	0.3	15,750.00
LHC17111033	5000	0.6	0.2	15,750.00
LHC17111038	10000	0.6	0.2	15,750.00
HSN Code	90318000			

Technical Data & Ordering Information - Variable volume

Model Name	Volume Range (µl)	Volume Increment (µl)	Inaccuracy (%)	Imprecision (%)	Prices / Piece ₹
LHC17112002	0.2-2	0.02	2.0	1.00	20,160.00
LHC17112005	0.5-10	0.10	1.0	0.50	20,160.00
LHC17112008	2-20	0.20	1.0	0.30	20,160.00
LHC17112016	5-50	0.50	1.0	0.30	20,160.00
LHC17112020	10-100	1.00	0.7	0.20	20,160.00
LHC17112024	20-200	2.00	0.6	0.20	20,160.00
LHC17112029	100-1000	10.00	0.8	0.20	20,160.00
LHC17112033	1000-5000	50.00	0.6	0.15	20,160.00
LHC17112038	1000-10000	20.00	0.6	0.15	20,160.00
HSN Code	84798200				

Optional Accessories

Description	Product Code	Qty/Pack	Prices / Piece ₹
C1 Fixed Vol Knob	On Request	1	2,630.00
C1 Variable Vol Knob	On Request	1	4,310.00

Micropipettes

C1 Multichannel pipettes minimize human error and maximize the reliability of manual liquid transfer in scientific experiments.

- Ergonomically designed for stress free pipetting
- Recommended for ELISA test
 - Molecular screening
 - Kinetic studies
 - DNA Amplification



Technical Data & Ordering Information - 8 channel

Model Name	Volume Range (µl)	Volume Increment (µl)	Inaccuracy (%)	Imprecision (%)	Prices / Piece ₹
LHC17113001	0.5-10	0.1	2.00	1.00	34,280.00
LHC17113002	2-20	0.2	2.00	1.00	34,280.00
LHC17113009	5-50	0.5	1.40	0.60	34,280.00
LHC17113016	10-100	1	1.30	0.50	34,280.00
LHC17113020	20-200	2	1.20	0.40	34,280.00
LHC17113022	30-300*	2	1.40	0.30	34,280.00
HSN Code	90318000				

* 30 - 300 µl Multichannel pipetti is available with two knoba : 30 - 200 µl & 125-300 µl

Technical Data & Ordering Information - 12 channel

Model Name	Volume Range (µl)	Volume Increment (µl)	Inaccuracy (%)	Imprecision (%)	Prices / Piece ₹
LHC17114001	0.5-10	0.1	2.00	1.00	38,140.00
LHC17114002	2-20	0.2	2.00	1.00	38,140.00
LHC17114009	5-50	0.5	1.40	0.60	38,140.00
LHC17114016	10-100	1.0	1.30	0.50	38,140.00
LHC17114020	20-200	2.0	1.20	0.40	38,140.00
LHC17114022	30-300*	2.0	1.40	0.30	38,140.00
HSN Code	90318000				

* 30 - 300 µl Multichannel pipetti is available with two knoba : 30 - 200 µl & 125-300 µl

Technical Data & Ordering Information -

Model Name	Description	Prices / Piece ₹
LHC07009006	Micropipette stand for 6 Single Channel Pipette	On Request



Micropipettes

C3 Lightweight, Ergonomic pipette design for every lab application

- Crafted for a comfortable 4 lightweight user experience
- Compatible with universal tips
- ideal shaft for reaching into narrow/deep tubes.



Technical Data & Ordering Information - Fixed volume

Model Name	Volume Range (µl)	Inaccuracy (%)	Imprecision (%)	Prices / Piece ₹
LHC37111001	1	2.5	1.8	4,230.00
LHC37111002	2	2.5	1.2	4,230.00
LHC37111005	5	1.2	0.8	4,230.00
LHC37111006	10	1.0	0.5	4,230.00
LHC37111008	20	1.0	0.3	4,230.00
LHC37111009	25	0.8	0.4	4,230.00
LHC37111010	30	1.2	0.4	4,230.00
LHC37111012	50	1.0	0.3	4,230.00
LHC37111016	100	0.7	0.2	4,230.00
LHC37111020	200	0.6	0.2	4,230.00
LHC37111021	250	0.4	0.2	4,230.00
LHC37111024	500	0.8	0.2	4,230.00
LHC37111029	1000	0.8	0.2	4,230.00
LHC37111033	5000	0.6	0.2	4,230.00
LHC37111038	10000	0.6	0.2	4,230.00
HSN Code	90318000			

Technical Data & Ordering Information - Variable volume

Model Name	Volume Range (µl)	Volume Increment (µl)	Inaccuracy (%)	Imprecision (%)	Prices / Piece ₹
LHC37112002	0.2-2	0.01	2.00	1.0	5,880.00
LHC37112005	0.5-10	0.10	1.00	0.5	5,880.00
LHC37112008	2-20	0.10	1.00	0.3	5,880.00
LHC37112016	5-50	0.50	1.00	0.3	5,880.00
LHC37112020	10-100	0.50	0.70	0.2	5,880.00
LHC37112024	20-200	1.00	0.60	0.2	5,880.00
LHC37112029	100-1000	5.00	0.80	0.2	5,880.00
LHC37112033	500-5000	50.00	0.60	0.2	5,880.00
LHC37112038	1000-10000	100.00	0.60	0.15	5,880.00
HSN Code	90318000				

Micropipettes

C3 Lightweight, Ergonomic pipette design for every lab application

- Engineered to reach into narrow/deep tubes
- Comfortable finger rest for both right & left hand usage.



Technical Data & Ordering Information - 8 channel

Model Name	Volume Range (µl)	Volume Increment (µl)	Inaccuracy (%)	Imprecision (%)	Prices / Piece ₹
LHC37113001	0.5-10	0.10	1.5.	1.50	21,140.00
LHC37113009	5-50	0.50	1.00	0.70	21,140.00
LHC37113016	10-100	0.50	1.00	0.50	21,140.00
LHC37113020	20-200	1.0	0.70	0.25	21,140.00
LHC37113022	30-300	1.0	0.80	0.25	21,140.00
HSN Code	90318000				

Technical Data & Ordering Information - 12 channel

Model Name	Volume Range (µl)	Volume Increment (µl)	Inaccuracy (%)	Imprecision (%)	Prices / Piece ₹
LHC37114001	0.5-10	0.1	1.50	1.50	26,420.00
LHC37114009	5-50	0.5	1.00	0.70	26,420.00
LHC37114016	10-100	0.5	1.00	0.50	26,420.00
LHC37114020	20-200	1.0	0.70	0.25	26,420.00
LHC37114022	30-300	1.0	0.80	0.25	26,420.00
HSN Code	90318000				

Technical Data & Ordering Information -

Model Name	Description	Prices / Piece ₹
LHC07009004	Micropipette stand for 4 Single Channel Pipette	3636



Electronic Micropipettes

Electronic pipettes are ergonomic with features of pipetting, dispensing programs & reduce muscle strain by performing pipetting steps for the user

- Exceptionally lightweight for effortless pipetting.
- Explore 5 different pipetting modes: Forward Pipetting, Reverse Pipetting Multi dispensing, Diluting & Mixing
- Intelligent sleep mode for battery conservation.



Technical Data & Ordering Information -

Model Name	Volume Range (µl)	Volume Increment (µl)	Inaccuracy (%)	Imprecision (%)	Prices / Piece ₹
LHC17022008	10-200	0.1	0.6	0.2	38.840.00
LHC17022012	5-100	0.1	0.8	0.2	38.840.00
LHC17022016	250 - 5000	5	0.6	0.2	38.840.00
LHC17022024	50 - 1000	1	0.6	0.2	38.840.00
LHC17022042	0.5-10	0.01	1	1	38.840.00
HSN Code	90318000				

UV Sterilization Box

Experience rapid, residue-free disinfection with our multi-purpose UV sterilization box. Utilizing UV-C technology, it swiftly and effectively sanitizes without harmful chemicals or residues, ensuring an environmentally friendly and hassle-free solution for your sterilization needs.

Technical Specification

Model No.	DIC020
Inbuilt timer	User selectable from 5 to 30 minutes
Incremental time	5 mins
UV C lamp make	CE Certified GERMICIDAL UVC lamp
UV C lamp life	11000 hrs
UV C lamp wattage	11W X 4
Outer dimension (LXDXH)	430 * 380 * 235mm
Inner dimension (LXDXH)	420 * 255 * 170mm
Maintenance	UVC lamps user replaceable
Unit Power	45 W
Input power	230V 50Hz Ac
Ordering Information	BLFGDIC01000000000



Electronic Micropipettes

Technical Data & Ordering Information - 8 channel

Model Name	Volume Range (µl)	Volume Increment (µl)	Prices / Piece ₹
LHC17023001	0.5-10	0.010	63,130.00
LHC17023002	2-20	0.01	63,130.00
LHC17023016	5-100	0.10	63,130.00
LHC17023020	10-200	0.10	63,130.00
LHC17023022	15-300	0.10	63,130.00
HSN Code	90318000		

Technical Data & Ordering Information - 12 channel

Model Name	Volume Range (µl)	Volume Increment (µl)	Prices / Piece ₹
LLHC17024001	0.5-10	0.01	71,310.00
LHC17024002	2-20	0.01	71,310.00
LHC17024016	5-100	0.10	71,310.00
LHC17024020	10-200	0.10	71,310.00
LHC17024022	15-300	0.10	71,310.00
HSN Code	90318000		



Electronic Pipette Controller

FAST PIPETTE Pipette Controller:
Pipette filling device

- Can hold plastic or glass pipette from 0.1ml upto 100ml
- Double safety valve & hydrophobic filters offer double protection against fluid penetration.

Technical Data & Ordering Information

Product Code	Description
LHC17005011	Pipette filling device
HSN Code	0318000
Prices / Piece	20,690.00





NEW

Experience the ease of
precise titration with

LABQUEST
BY BOROSIL®

e-Titrate

DIGITAL BURETTE

DIY
DO IT YOURSELF
Re-Calibration

Premium Micro Pipette Tips

Free of PCR inhibitors, lubricants and heavy metals

With graduations for visual control of liquid transfer

Certified DNase, RNase and Pyrogen Free

Produced from special diamond polish mould using medical grade virgin polypropylene which provides very high transparency

Available in both standard as well as low retention

With no secondary treatment and with no silicone additives for low retention

With special PE filters for prevention of aerosols and contamination

Specifically configured to fit major Pipette Brands available worldwide

FILTER TIPS

BOROSIL filter tips are manufactured using specifically developed Polyethylene filters to block aerosols from entering into the pipette.

This helps in prevention of cross contamination.

Ideal for use in applications like sequencing, DNA amplification, Tissue culture, RT-PCR and other critical protocols.

































LOW RETENTION TIPS

BOROSIL low retention tips are manufactured from a specific resin in combination with high quality diamond finish moulds to give super hydrophobic internal surface. This results in tips having minimum retention with maximum accuracy.

Further since no silicone treatment is given, there is absolutely no leaching effect.



Tips and Filter Tips

							
10 XL-FILTER-TIP	10 XL-Tip	10 XN-tips	10 XN-with-Filter-Tips	10µL LONG			
							
10µL XL Extra Narrow	10µL	20-200 with filter	100 µL-Tip	100µL			
							
200 µL-FILTER-TIP	100 µL-Tip	100 µL	200 µL-FILTER-TIP	200 µL-Tip			
							
200 XL-Tips	200 XL-with-Filter-Tips	200 µL	300µL	1000 µL-FILTER-TIP			
							
1000 µL-Tip	1000µL	1000XL-LONG-TIP	1000XL-LONG-TIP-WITH-FILTER	1250µL			
							
AT-5000A	AT-5000A	AT-5000B	AT-5000B	AT-10000A	AT-10000A	AT-10000B	AT-10000B

Tips

The ergonomically optimized cone geometry provides the optimal pipette fit for Labquest Pipette

Technical Data & Ordering Information

Universal Graduated Tips Bulk Pack

Product Code	Short Code	Tip Vol. (µl)	Special Feature	Selling Unit	Prices / Piece
BGT000010B	BGT-10B	10	-	1000 Tips / pack	600.00
BGT0000200B	BGT-200B	200	-	1000 Tips/ pack	560.00
BGT0001000B	BGT-1000B	1000	-	1000 Tips/ pack	840.00
BGT0C10005000B	BGT-C10005	5000	Only C1	100 Tips/ pack	1350.00
BGT0C30005000B	BGT-C30005	5000	Only C3	100 Tips/ pack	1350.00
BGT0C10010000B	BGT-C10010	10000	Only C1	100 Tips/ pack	3040.00
BGT0C30010000B	BGT-C30010	10000	Only C3	100 Tips/ pack	3040.00

Universal Graduated Tips Racks

Product Code	Short Code	Tip Vol. (µl)	Special Feature	Selling Unit	Prices / Piece
BGT000010R	BGT-10	10	-	10 × 96 Tips/rack	2,500.00
BGT0000200R	BGT-200R	200	-	10 × 96 Tips/rack	2,380.00
BGT0001000R	BGT-1000R	1000	-	6 × 96 Tips/ rack	1,540.00

Universal Graduated Tips Racks Sterile

Product Code	Short Code	Tip Vol. (µl)	Special Feature	Selling Unit	Prices / Piece
BGT000010SR	BGT-10SR	10	-	10 × 96 Tips/rack	2,700.00
BGT0000200SR	BGT-200SR	200	-	10 × 96 Tips/rack	2,570.00
BGT001000SR	BGT-1000SR	1000	-	6 × 96 Tips/ rack	1,780.00

Universal Graduated Tip Racks Sterile Low Retention

Product Code	Short Code	Tip Vol. (µl)	Special Feature	Selling Unit	Prices / Piece
BGT00010SLR	BGT-10SLR	10	-	10 × 96 Tips/rack	2,880.00
BGT000200SLR	BGT-200SLR	200	-	10 × 96 Tips/rack	2,820.00
BGT01000SLR	BGT-1000SLR	1000	-	6 × 96 Tips/ rack	2,300.00

Universal Graduated Tip Reload Stack Sterile

Product Code	Short Code	Tip Vol. (µl)	Special Feature	Selling Unit	Prices / Piece
BGT000010SZ	BGT-10SZ	10	-	10 × 96 Tips / rack	1,850.00
BGT0000200SZ	BGT-200SZ	200	-	10 × 96 Tips / rack	1,770.00
BGT001000SZ	BGT-1000SZ	1000	-	5 × 96 Tips/ rack	1,330.00

Universal Graduated Tip Reload Stack Sterile Low Retention

Product Code	Short Code	Tip Vol. (µl)	Special Feature	Selling Unit	Prices / Piece
BGT00010SLZ	BGT-10SLZ	10	-	10 × 96 Tips / rack	2,170.00
BGT000200SLZ	BGT-200SLZ	200	-	10 × 96 Tips / rack	2,120.00
BGT01000SLZ	BGT-1000SLZ	1000	-	5 × 96 Tips/ rack	1,650.00

Filter Tips

Protect pipettes and valuable samples from contamination with Labquest Filter Tips

Technical Data & Ordering Information

Universal Graduated Filter Tips Bulk Pack

Product Code	Short Code	Tip Vol. (µl)	Special Feature	Selling Unit	Prices / Piece
BGT000010FB	BGT-10FB	10	-	1000 Tips/ pack	2,760.00
BGT000020FB	BGT-20FB	20	-	1000 Tips/ pack	2,760.00
BGT000050FB	BGT-50FB	50	-	1000 Tips/ pack	2,760.00
BGT000100FB	BGT-100FB	100	-	1000 Tips/ pack	2,760.00
BGT000200FB	BGT-200FB	200	-	1000 Tips/ pack	2,760.00
BGT001000FB	BGT-1000FB	1000	-	1000 Tips/ pack	3,420.00

Universal Graduated Tips Racks

Product Code	Short Code	Tip Vol. (µl)	Special Feature	Selling Unit	Prices / Piece
BGT000010FR	BGT-10FR	10	-	10 × 96 Tips/rack	3,930.00
BGT000020FR	BGT-20FR	20	-	10 × 96 Tips/rack	3,930.00
BGT000050FR	BGT-50FR	50	-	10 × 96 Tips/rack	3,930.00
BGT000100FR	BGT-100FR	100	-	10 × 96 Tips/rack	3,930.00
BGT000200FR	BGT-200FR	200	-	10 × 96 Tips/rack	3,930.00
BGT001000FR	BGT-1000FR	1000	-	6 × 96 Tips/ rack	2,760.00

Universal Graduated Filter Tip Rack Sterile

Product Code	Short Code	Tip Vol. (µl)	Special Feature	Selling Unit	Prices / Piece
BGT00010SFR	BGT-10SFR10	10	-	10 × 96 Tips/rack	4,070.00
BGT00020SFR	BGT-20SFR	20	-	10 × 96 Tips/rack	4,070.00
BGT00050SFR	BGT-50SFR	50	-	10 × 96 Tips/rack	4,070.00
BGT00100SFR	BGT-100SFR	100	-	10 × 96 Tips/rack	4,070.00
BGT00200SFR	BGT-200SFR	200	-	10 × 96 Tips/rack	4,070.00
BGT01000SFR	BGT-1000SFR	1000	-	6 × 96 Tips/ rack	3,030.00

Universal Graduated Filter Tip Rack Sterile Low Retention

Product Code	Short Code	Tip Vol. (µl)	Special Feature	Selling Unit	Prices / Piece
BGT0010SLFR	BGT-10SLFR	10	-	10 × 96 Tips/rack	4,980.00
BGT0020SLFR	BGT-20SLFR	20	-	10 × 96 Tips/rack	4,980.00
BGT0050SLFR	BGT-50SLFR	50	-	10 × 96 Tips/rack	4,980.00
BGT0100SLFR	BGT-100SLFR	100	-	10 × 96 Tips/rack	4,980.00
BGT0200SLFR	BGT-200SLFR	200	-	10 × 96 Tips/rack	4,980.00
BGT1000SLFR	BGT-1000SLFR	1000	-	6 × 96 Tips/ rack	3,740.00

Empty Tip Box

Product Code	Short Code	Tip Vol. (µl)	Special Feature	Selling Unit	Prices / Piece
BGT00010ETR	BGT-10ETR	10	-	10 Rack Boxes	1,960.00
BGT00200ETR	BGT-200ETR	200	-	10 Rack Boxes	1,960.00
BGT01000ETR	BGT-1000ETR	1000	-	6 Rack Boxes	1,310.00

Introducing cutting-edge glass reactors with full automation from India's leading scientific glass manufacturer. Customize your needs with our exclusive range, including block-based carousels, bath-based spherical reactors, bench-top cylindrical reactors, and pilot plants, offering a comprehensive selection.

Our Offerings:

- Automated & Standard Lab Reactors up to 35 liters
- Pilot Plants & Turnkey Projects up to 250 liters
- Multi Reactor Station
- Automated Reflux Divider
- Motorised Liquid Dispenser
- Fume Scrubbers
- Filter Reactors & Nutsche Filters

Key Features:

- Process Consultation & Design Services
- Automation & System Integration
- CGMP Compliance
- ATEX Proof System
- HAZOP Compatible
- Customizable Solutions
- Documentation



PRODUCT PORTFOLIO

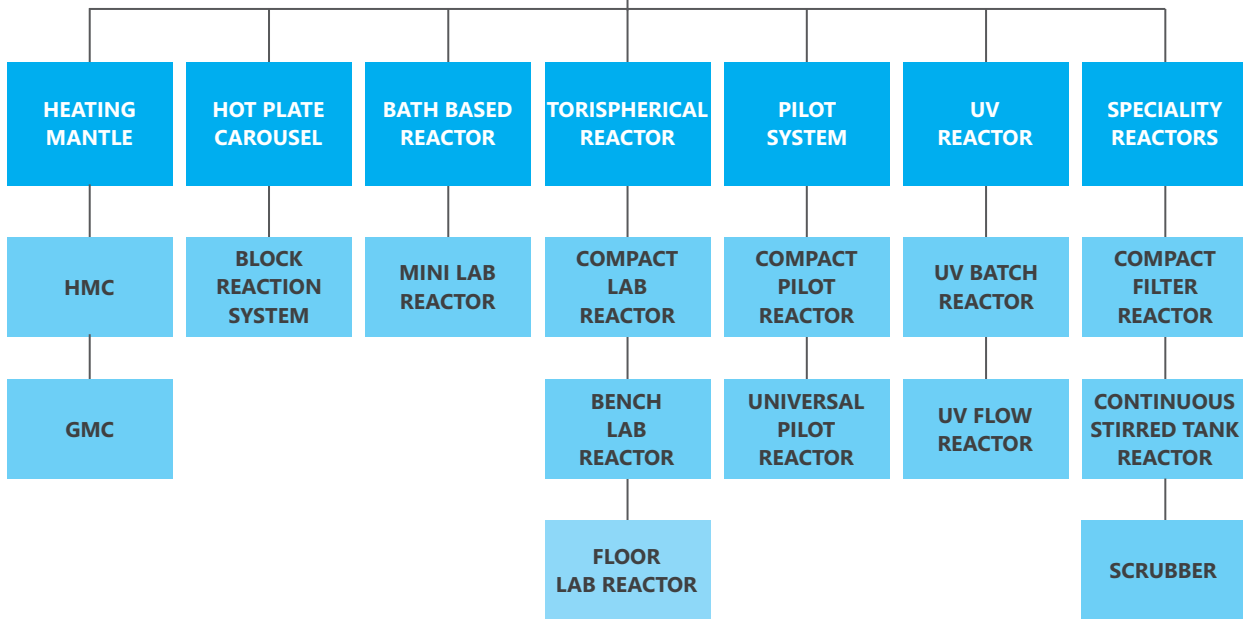

AUTOMATION

We commit to provide complete automation systems for Lab reactors and ensure that our users achieve absolute peak precision and efficiency in their processes. Our automation systems enable precise control of key parameters such as temperature, stirring speed and dosing. These systems cater recipe making, real-time monitoring and data logging capabilities, allowing for detailed analysis of reaction performance over time.



Auto Basic

➤ Upto 2 Devices

Auto Expert

➤ Upto 4 Devices

Auto Advanced

➤ 8+ Devices

Additions :

- PC based SCADA Solutions
- Power distribution with complete control

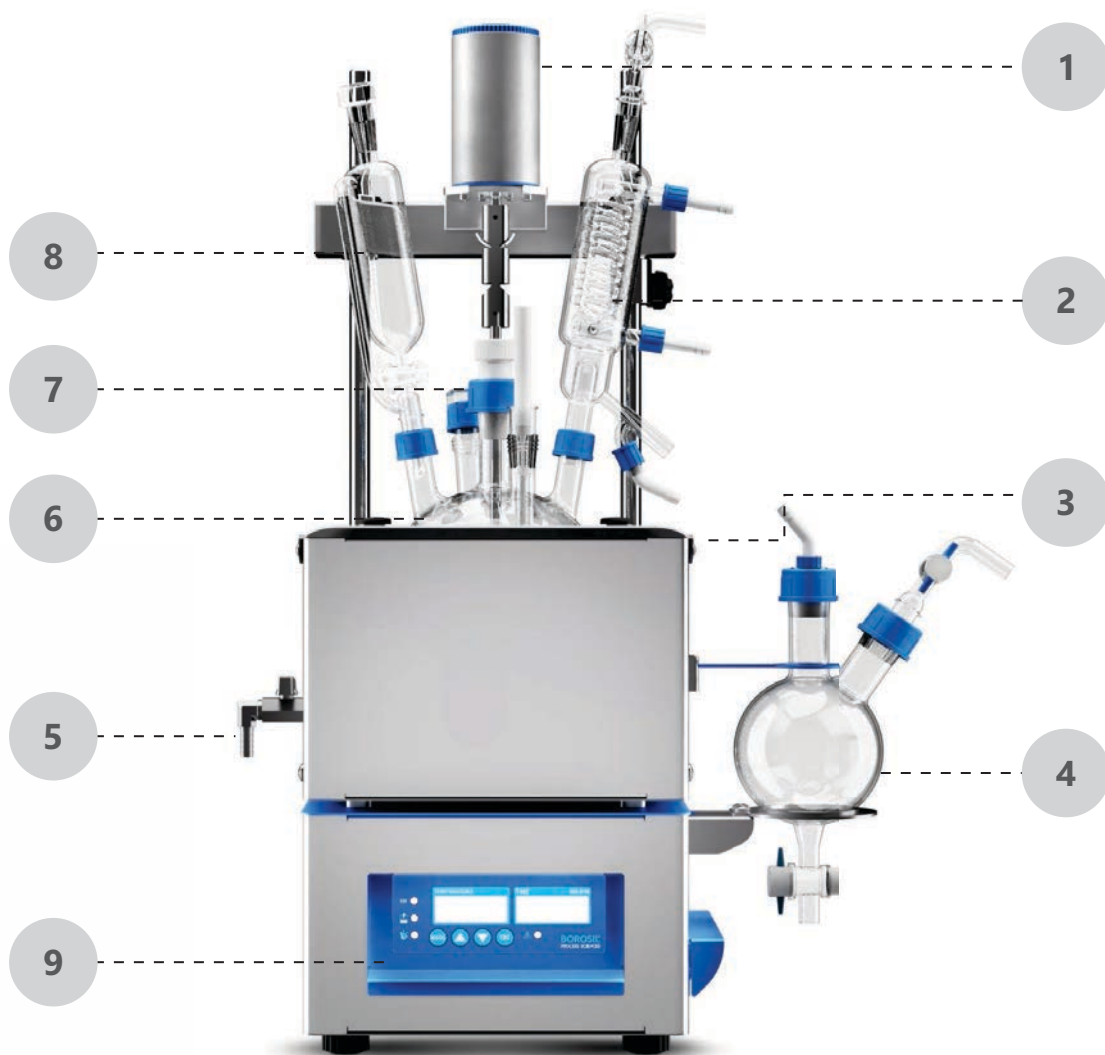

Sr. No.	Description	Qty	Part Code / Ref
1	Agitator Drive	1	Table No. 28
2	Condenser	1	Table No. 5
3	Heating Bath	1	BLA0MLR02030000000
4	Receiver Vessel	1	Table No. 7
5	Drain	1	BLA0BV00BR00080MLR
6	5 Neck Round Bottom Flask	1	Table No. 8
7	Agitator Assembly	1	Table No. 14
8	Feeding Funnel	1	Table No. 6
9	Control Unit	1	BLA0MLR02020000000

Mini Lab Reactor is available with a multi-neck round bottom flask, optimized for academic and research applications. It is a cost-effective solution that includes an oil bath-based heating that eliminates the need for an external heating system. We provide electronic control for temperature, speed, time, and step reaction. We provide optional cooling to prevent reaction runaway in case of an exothermic reaction. We supply explosion-proof variants for critical applications on special request.

Assembly Code	Capacity	Temperature °C	Pressure mBar	L x B x H mm
BLFRMLR2500000000	250 mL	ambient to 250	100 - 1000	480 x 300 x 750
BLFRMLR5000000000	500 mL	ambient to 250	100 - 1000	480 x 300 x 750
BLFRMLR0010000000	1 L	ambient to 250	100 - 1000	480 x 300 x 750
BLFRMLR0020000000	2 L	ambient to 250	100 - 1000	620 x 400 x 1000
BLFRMLR0030000000	3 L	ambient to 250	100 - 1000	620 x 400 x 1000
BLFRMLR0050000000	5 L	ambient to 250	100 - 1000	620 x 400 x 1000

** Customization are available as per requirements.

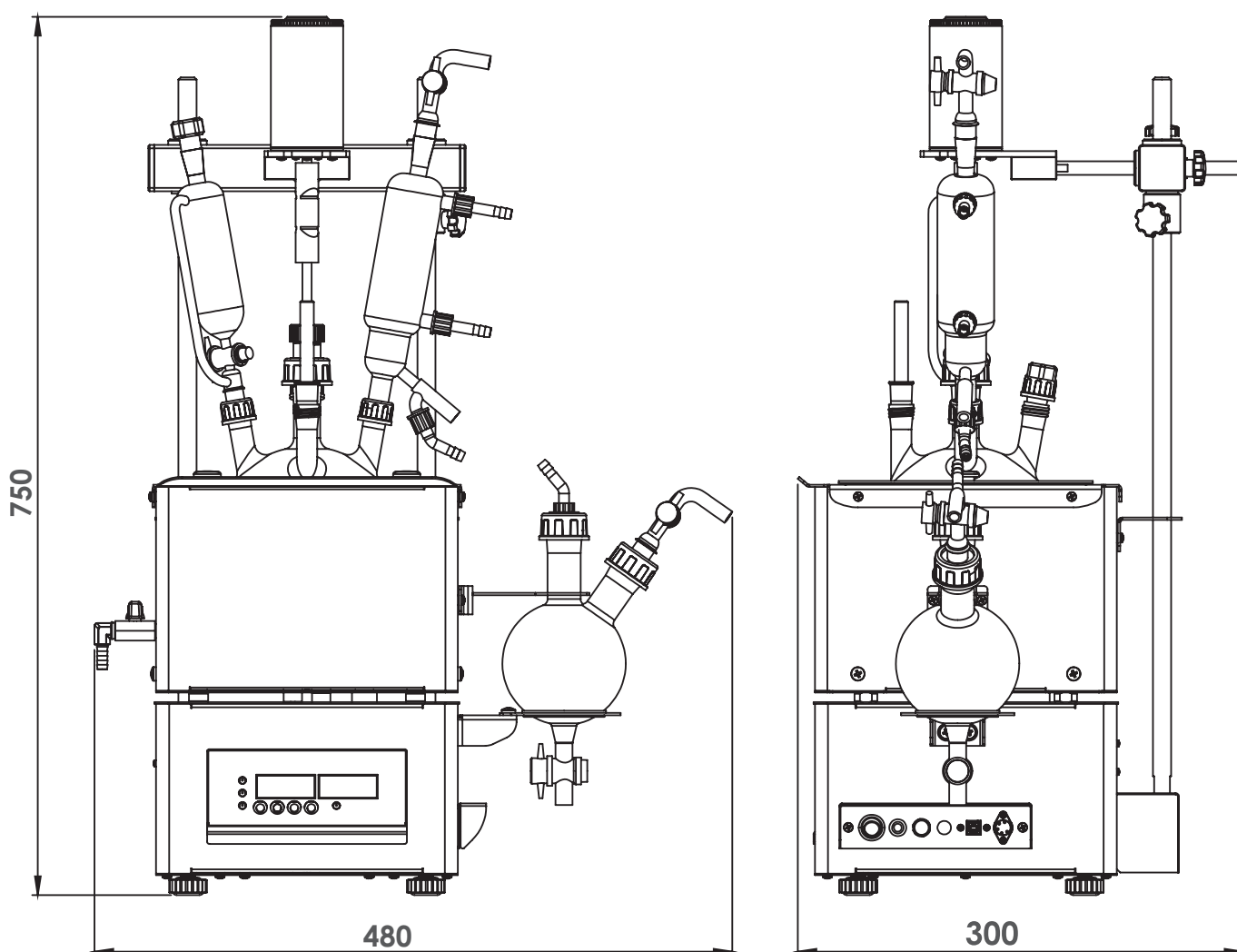

BRS

Block Based Reaction System

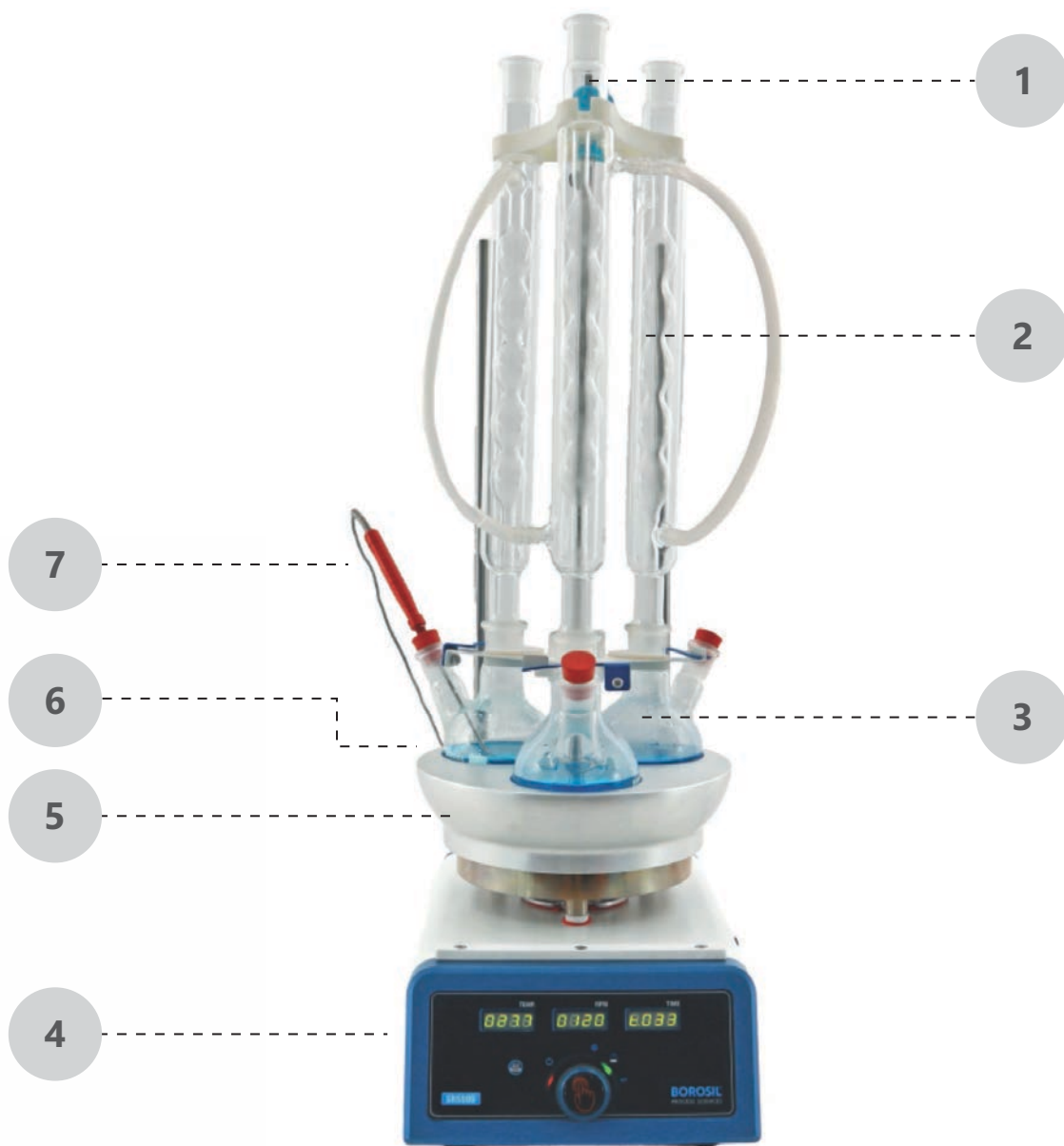

Sr. No.	Description	Qty	Part Code / Ref
1	Skid	1	Table No. 12
2	Condenser	1	Product Code 2340, 2400, 2480, 2560 2640, 2641
3	Round Bottom Flask	1	Product Code 4380, 4381
4	Control Unit	1	BLMRBRS005CNTRLUNT
5	Heating Block	1	Table No. 19
6	Magnetic Stir Bar	1	BLM0MSB0000002508D
7	Temperature Probe	1	Table No. 14.2

Block Reaction System provides solutions for many chemical reactions that require a constant input of heat to speed up the functional sequence. We offer a way to heat and stir round-bottom flasks with capacities ranging from 10 mL to 5L in the fastest, safest, and most efficient way. We also provide many multi-vessel reaction attachments, test tube heating blocks, vacuum suction manifolds, etc.

Assembly Code	Capacity	Temperature °C	Pressure Barg	L x B x H mm
BLMRBRS010XP000000	10 mL	ambient to 250	Full Vacuum to 0.5	230 x 360 x 620
BLMRBRS025XP000000	25 mL	ambient to 250	Full Vacuum to 0.5	230 x 360 x 620
BLMRBRS050XP000000	50 mL	ambient to 250	Full Vacuum to 0.5	230 x 360 x 620
BLMRBRS100XP000000	100 mL	ambient to 250	Full Vacuum to 0.5	230 x 360 x 620
BLMRBRS250XP000000	250 mL	ambient to 250	Full Vacuum to 0.5	230 x 360 x 620
BLMRBRS5001P000000	500 mL	ambient to 250	Full Vacuum to 0.5	230 x 360 x 620
BLMRBRS7501P000000	750 mL	ambient to 250	Full Vacuum to 0.5	230 x 360 x 620
BLMRBRS0011P000000	1 L	ambient to 250	Full Vacuum to 0.5	230 x 360 x 620
BLMRBRS0021P000000	2 L	ambient to 250	Full Vacuum to 0.5	230 x 360 x 620
BLMRBRS0031P000000	3 L	ambient to 250	Full Vacuum to 0.5	230 x 360 x 620
BLMRBRS0051P000000	5 L	ambient to 250	Full Vacuum to 0.5	230 x 360 x 620

** X=Multi Positions, Customization are available as per requirements.

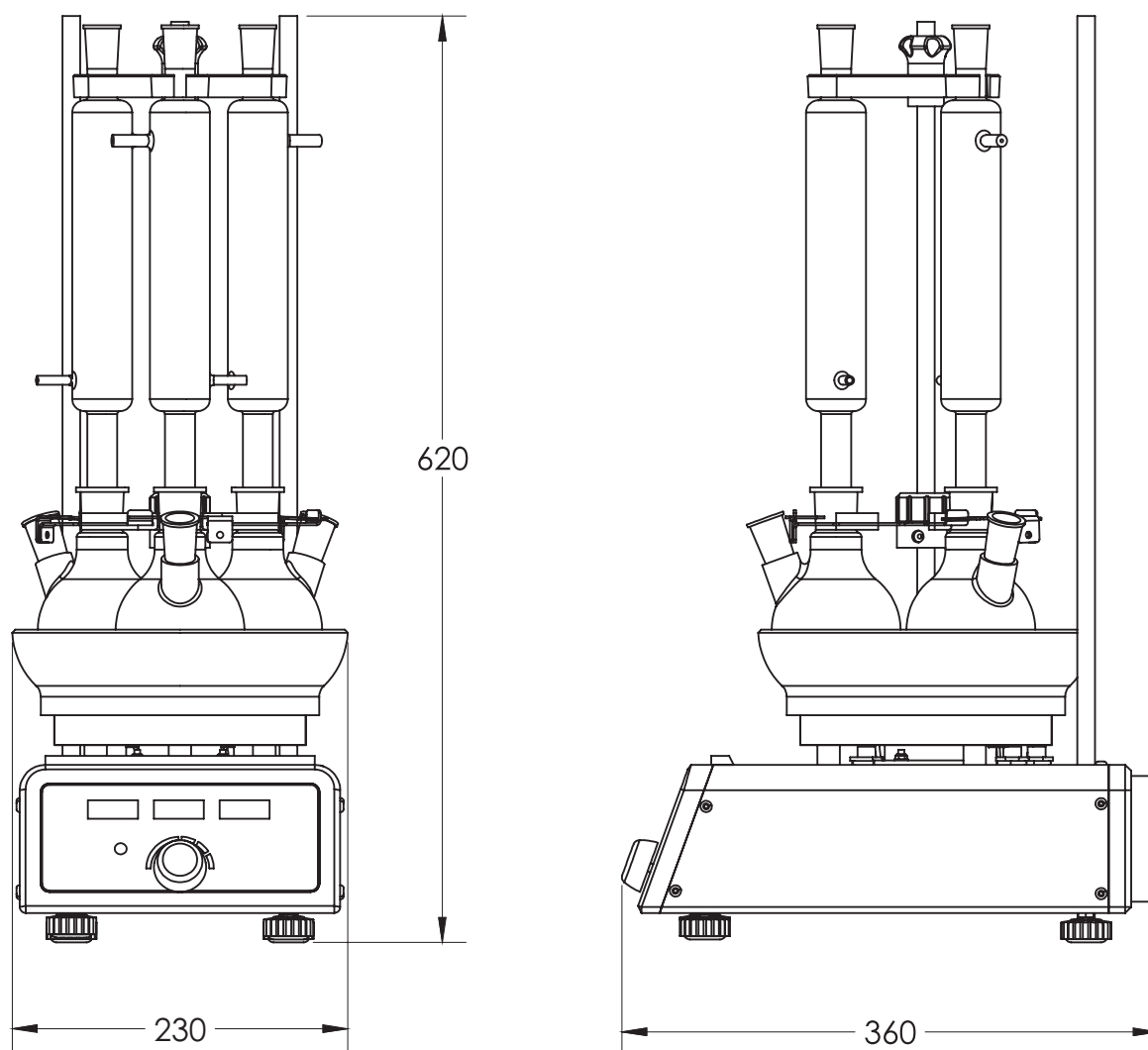

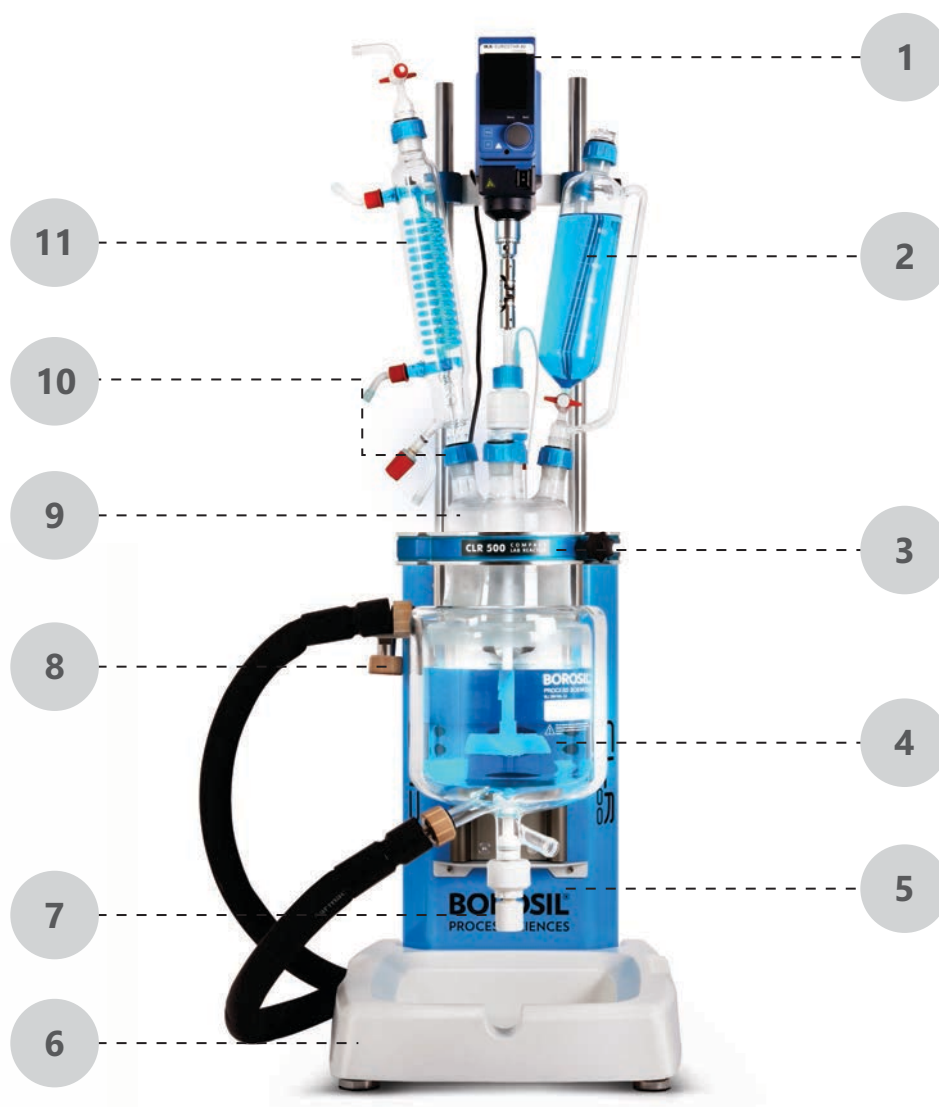

Sr. No.	Description	Qty	Part Code / Ref
1	Agitator Drive	1	Table No. 28
2	Feeding Funnel	1	Table No. 6
3	Integrated Neck Clamp	1	Table No. 9
4	Reactor Vessel	1	Table No. 1, 2
5	Mounting Skid	1	Table No. 12
6	Drip Tray	1	Table No. 15
7	Flush Bottom Valve	1	Table No. 13
8	Peek Hose Tidy	2	Table No. 11
9	Lid	1	Table No. 3, 4
10	Agitator Assembly	1	Table No. 14
11	Condenser	1	Table No. 5

Mini Compact Lab Reactor is a benchtop lab reactor designed with a three-pole agitator drive lifting mechanism for better stability at higher RPMs. Features such as quick vessel change, sturdy design for high viscous stirring, chemical-resistant collection tray and torque-limited vessel clamping make Mini CLR a preferred lab reactor for users.

Assembly Code	Capacity	Temperature °C	Pressure Barg	Flange Dia	L x B x H mm	Jacket
BLMRCLR250XJ000000	250 mL	-40 to 200	Full Vacuum to 0.5	DN 100	400 x 480 x 1100	Single/ Double
BLMRCLR500XJ000000	500 mL	-40 to 200	Full Vacuum to 0.5	DN 100	400 x 480 x 1100	Single/ Double
BLMRCLR750XJ000000	750 mL	-40 to 200	Full Vacuum to 0.5	DN 100	400 x 480 x 1100	Single/ Double
BLMRCLR001XJ000000	1 L	-40 to 200	Full Vacuum to 0.5	DN 100	400 x 480 x 1100	Single/ Double

**Customization are available as per requirements.

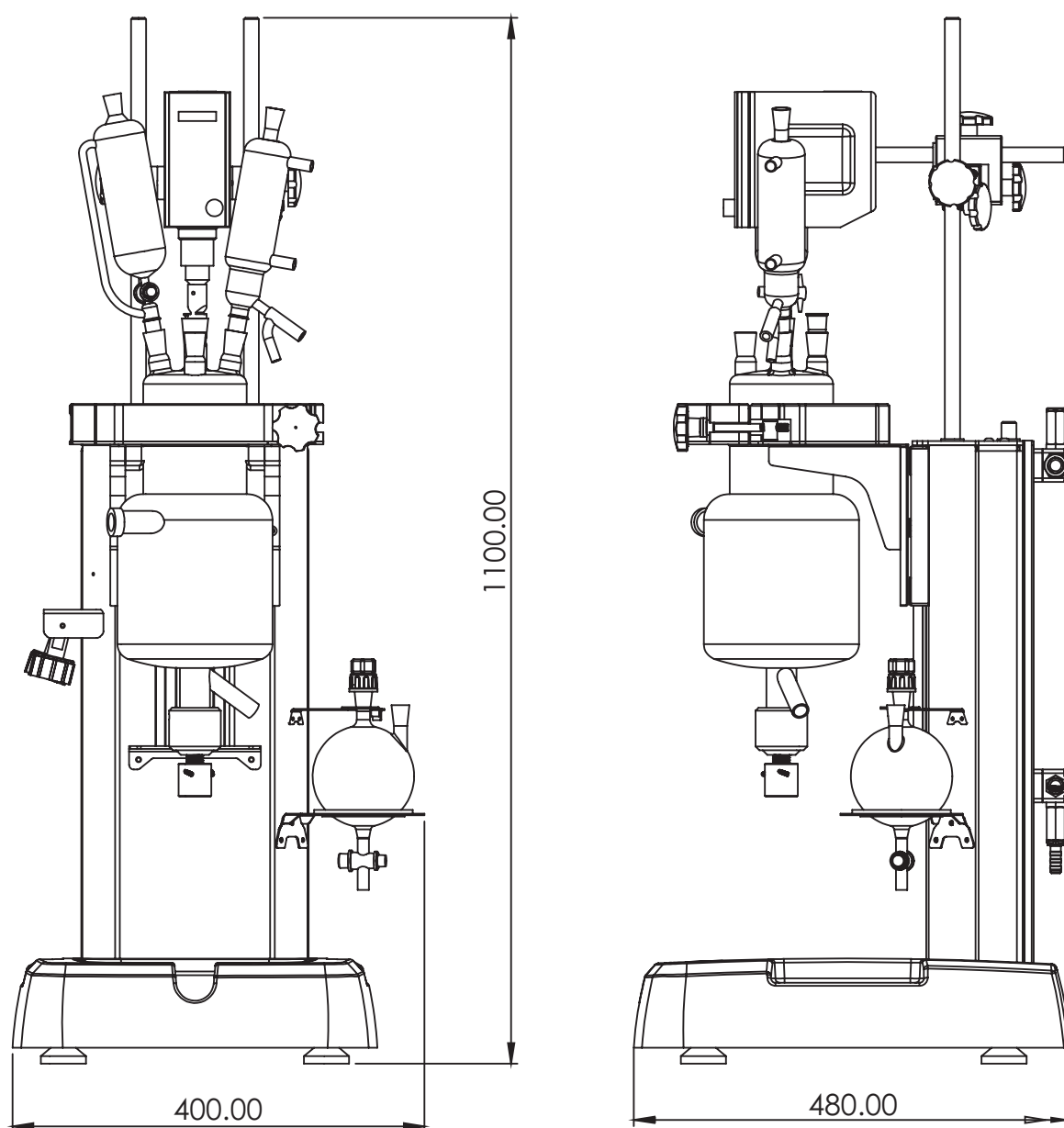

CLR

Compact Lab Reactor

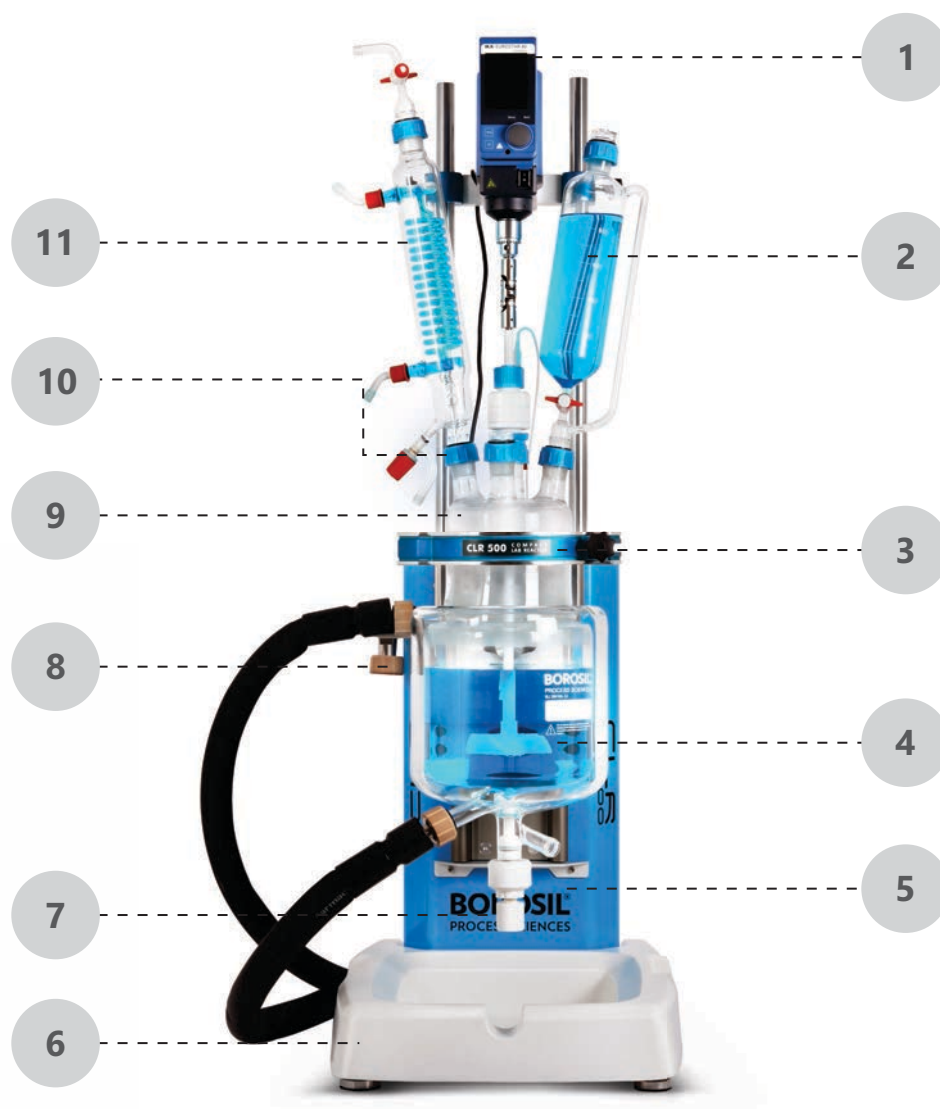

Sr. No.	Description	Qty	Part Code / Ref
1	Agitator Drive	1	Table No. 28
2	Feeding Funnel	1	Table No. 6
3	Integrated Neck Clamp	1	Table No. 9
4	Reactor Vessel	1	Table No. 1, 2
5	Mounting Skid	1	Table No. 12
6	Drip Tray	1	Table No. 15
7	Flush Bottom Valve	1	Table No. 13
8	Peek Hose Tidy	2	Table No. 11
9	Lid	1	Table No. 3, 4
10	Agitator Assembly	1	Table No. 14
11	Condenser	1	Table No. 5

Compact Lab Reactor is a benchtop lab reactor designed with a three-pole agitator drive lifting mechanism for better stability at higher RPMs. Features such as quick vessel change, sturdy design for high viscous stirring, chemical-resistant collection tray, and torque-limited vessel clamping make CLR a preferred lab reactor for users.

Assembly Code	Capacity	Temperature °C	Pressure Barg	Flange Dia	L x B x H mm	Jacket
BLMRCLR002XJ000000	2 L	-40 to 200	Full Vaccum to 0.5	DN 100	500 x 550 x 1300	Single/ Double
BLMRCLR003XJ000000	3 L	-40 to 200	Full Vaccum to 0.5	DN 100	500 x 550 x 1300	Single/ Double
BLMRCLR005XJ000000	5 L	-40 to 200	Full Vaccum to 0.5	DN 100	500 x 550 x 1300	Single/ Double

**Customization are available as per requirements.

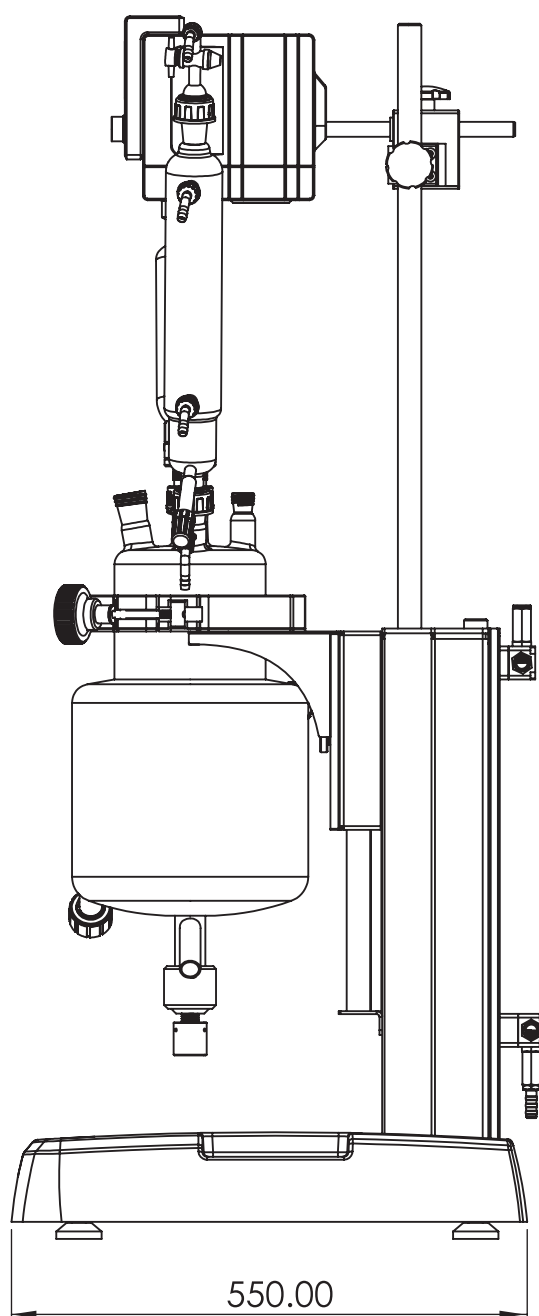
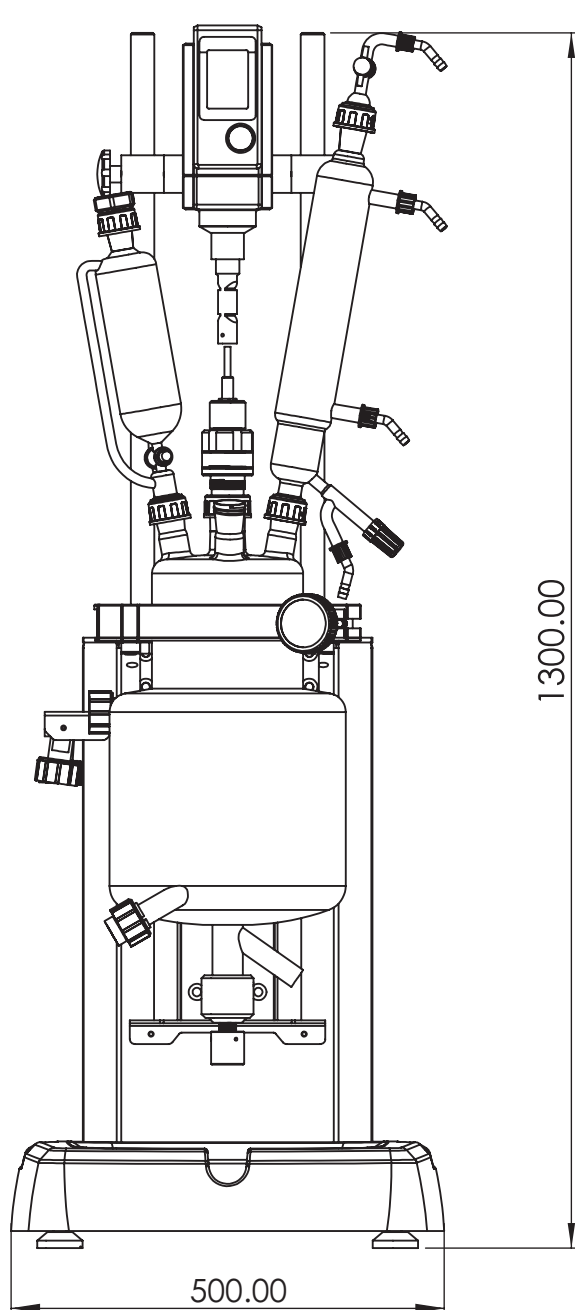

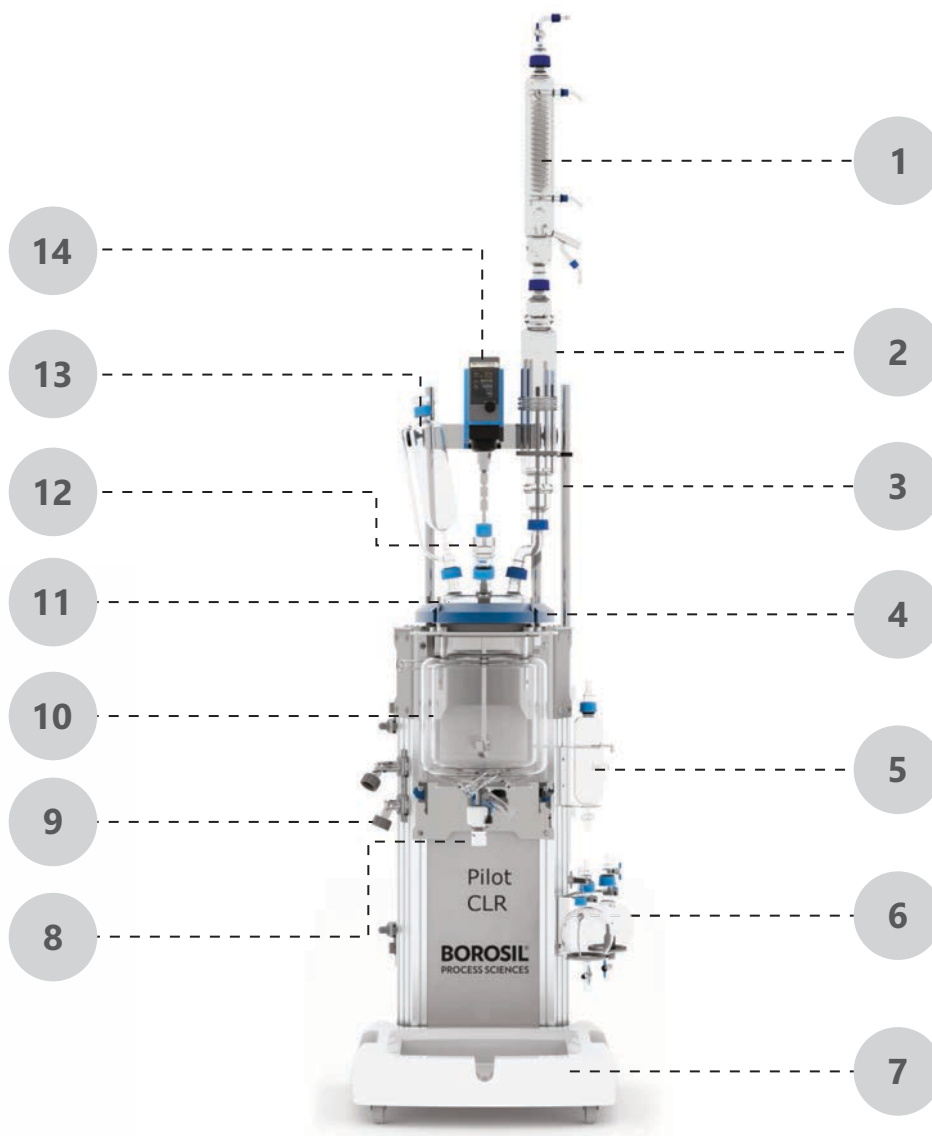

Sr. No.	Description	Qty	Part Code / Ref
1	Condenser	1	Table No. 5
2	Column	1	Table No. 17
3	Integrated Clamp	1	Table No. 9
4	Skid	1	Table No. 12
5	Phase Separator	1	Table No. 18
6	Receiving Flask	2	Table No. 7
7	Drip Tray	1	Table No. 15
8	Bottom Valve	1	Table No. 13
9	Peek Hose Tidy	2	Table No. 11
10	Reactor Vessel	1	Table No. 1, 2
11	Lid	1	Table No. 3,4
12	Agitator assembly	1	Table No. 14
13	Feeding Funnel	1	Table No. 6
14	Agitator Drive	1	Table No. 28

Compact Pilot Lab Reactor is a Floor standing lab reactor designed with a two-pole agitator drive lifting mechanism for better stability at higher RPMs & Viscous fluids. The glass column, with specialized packing, and borosilicate receiving flask ensure optimal separation, while the precision-engineered glass phase separator enables efficient and accurate liquid separation. Features such as quick vessel change, sturdy design for high viscous stirring, chemical-resistant collection tray, and torque-limited vessel clamping make CLR Pilot a preferred lab reactor for users.

Assembly Code	Capacity	Temperature °C	Pressure Barg	Flange Dia	L x B x H mm	Jacket
BLMRFLR010XJ000000	10 L	-40 to 200	Full Vacuum to 0.5	DN 200	700 x 700 x 2600	Single/ Double
BLMRFLR015XJ000000	15 L	-40 to 200	Full Vacuum to 0.5	DN 200	700 x 700 x 2600	Single/ Double
BLMRFLR020XJ000000	20 L	-40 to 200	Full Vacuum to 0.5	DN 200	700 x 700 x 2600	Single/ Double
BLMRFLR025XJ000000	25 L	-40 to 200	Full Vacuum to 0.5	DN 200	700 x 700 x 2600	Single/ Double
BLMRFLR030XJ000000	30 L	-40 to 200	Full Vacuum to 0.5	DN 200	700 x 700 x 2600	Single/ Double

**Customization are available as per requirements.

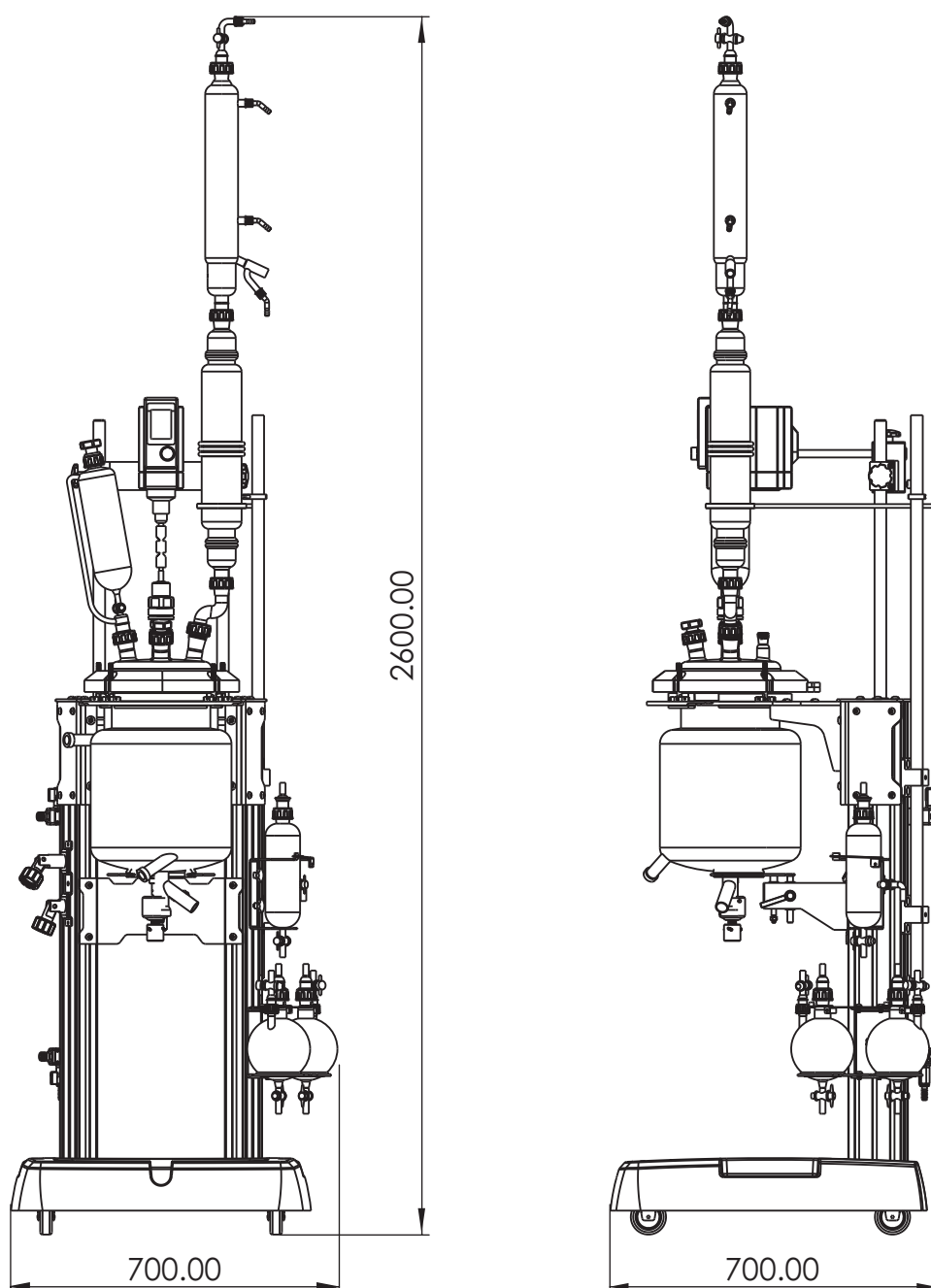

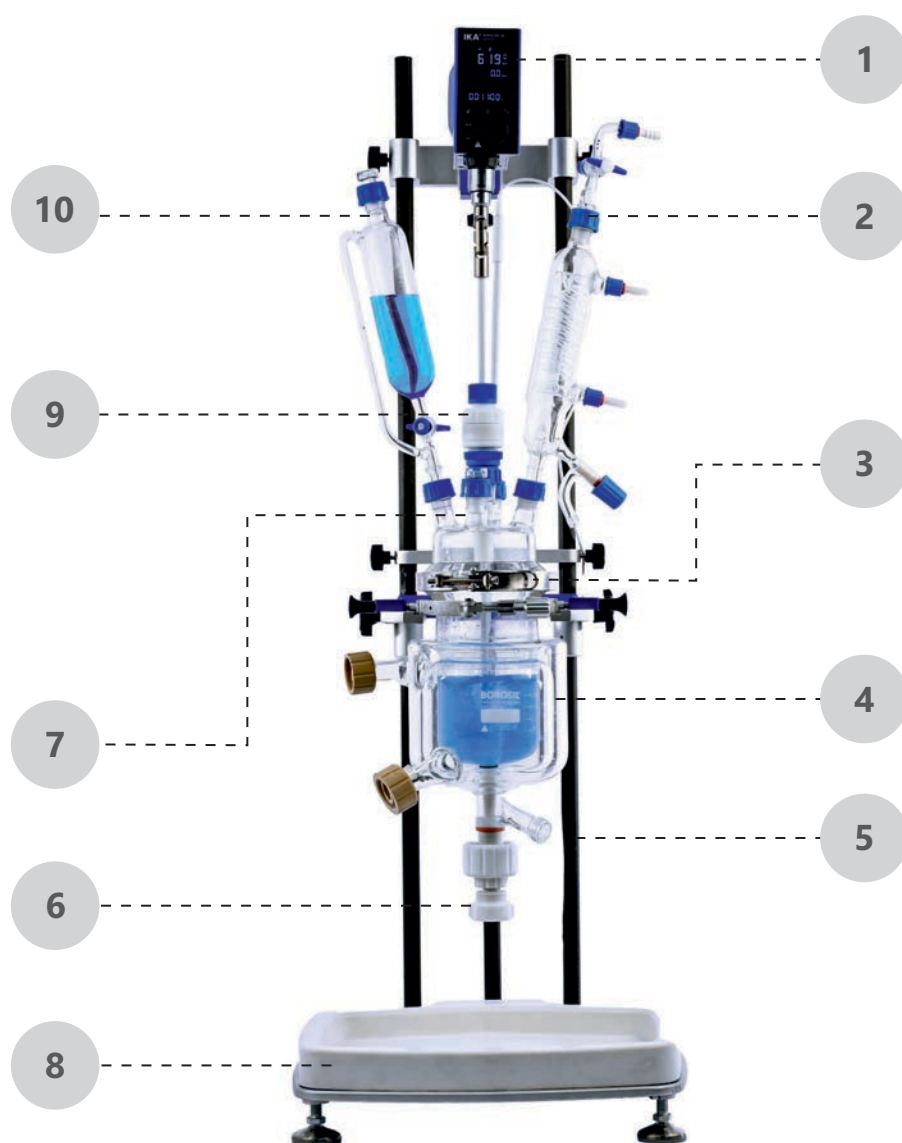

Sr. No.	Description	Qty	Part Code / Ref
1	Agitator Drive	1	Table No. 28
2	Condenser	1	Table No. 5
3	Quick Release Clamp	1	Table No. 10
4	Reactor Vessel	1	Table No. 1, 2
5	Mounting Skid	1	Table No. 12
6	Flush Bottom valve	1	Table No. 13
7	Lid	1	Table No. 3, 4
8	Tray	1	Table No. 15
9	Agitator Accessories	1	Table No. 14
10	Feeding Funnel	1	Table No. 6

Bench Lab Reactor is available with SS304 tubular skid arrangement and can accommodate a wide range of vessels from 100mL to 1L. The system features rapid and seamless interchangeability of vessel. The unit is available with single or double jacketed vessel, optional electric or pneumatic motor, and other customization options. We provide Teflon-coated skid on special request.

Assembly Code	Capacity	Temperature °C	Pressure Barg	Flange Dia	L x B x H mm	Jacket
BLMRBLR250XJ000000	250 mL	-40 to 200	Full Vacuum to 0.5	DN 100	320 x 400 x 1250	Single/ Double
BLMRBLR500XJ000000	500 mL	-40 to 200	Full Vacuum to 0.5	DN 100	320 x 400 x 1250	Single/ Double
BLMRBLR750XJ000000	750 mL	-40 to 200	Full Vacuum to 0.5	DN 100	320 x 400 x 1250	Single/ Double
BLMRBLR001XJ000000	1 L	-40 to 200	Full Vacuum to 0.5	DN 100	320 x 400 x 1250	Single/ Double

**Customization are available as per requirements.

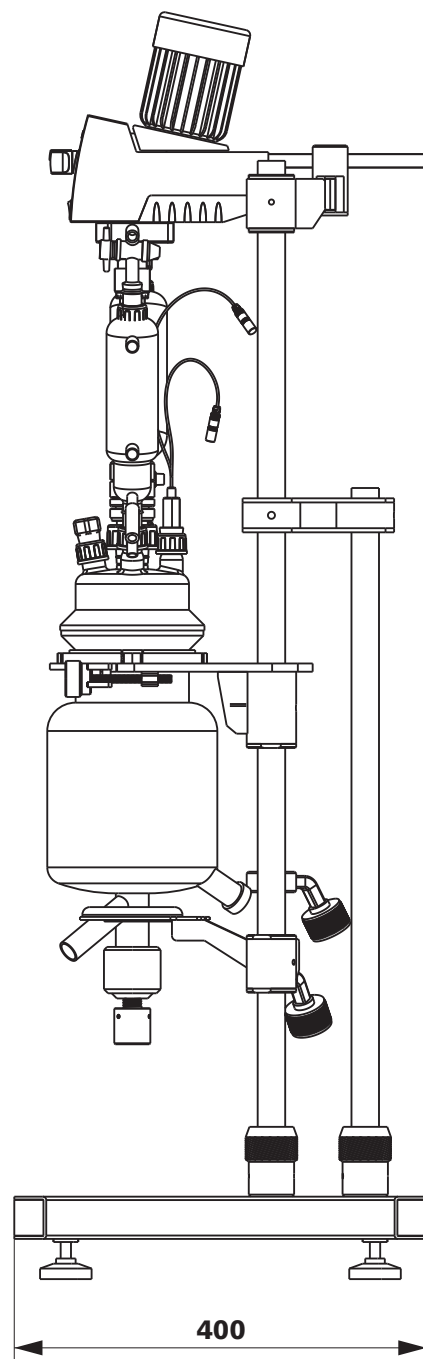
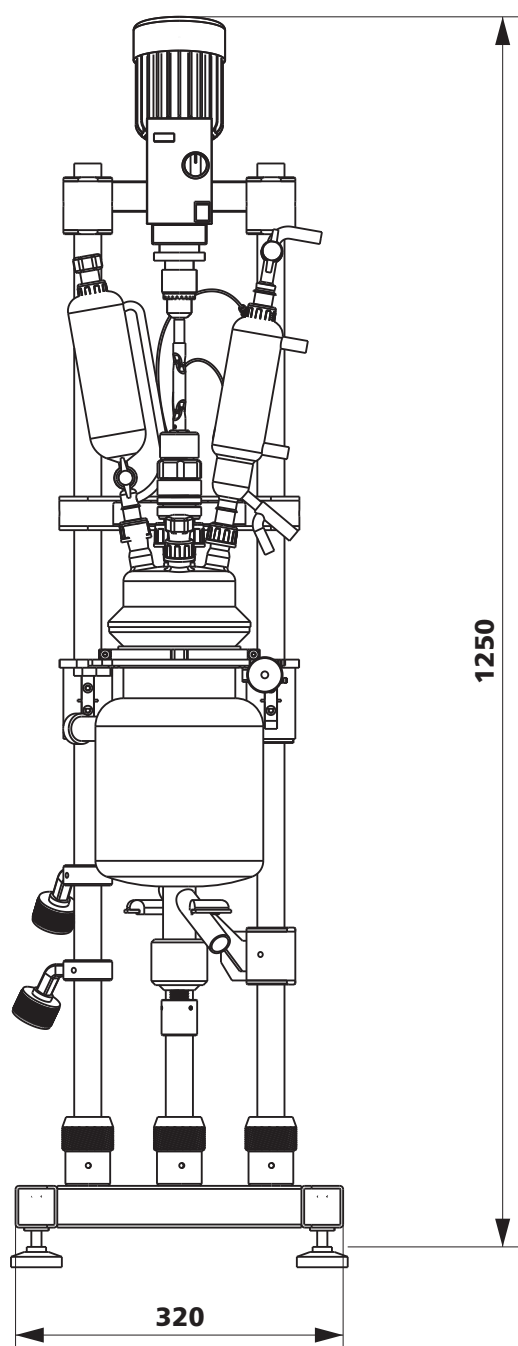

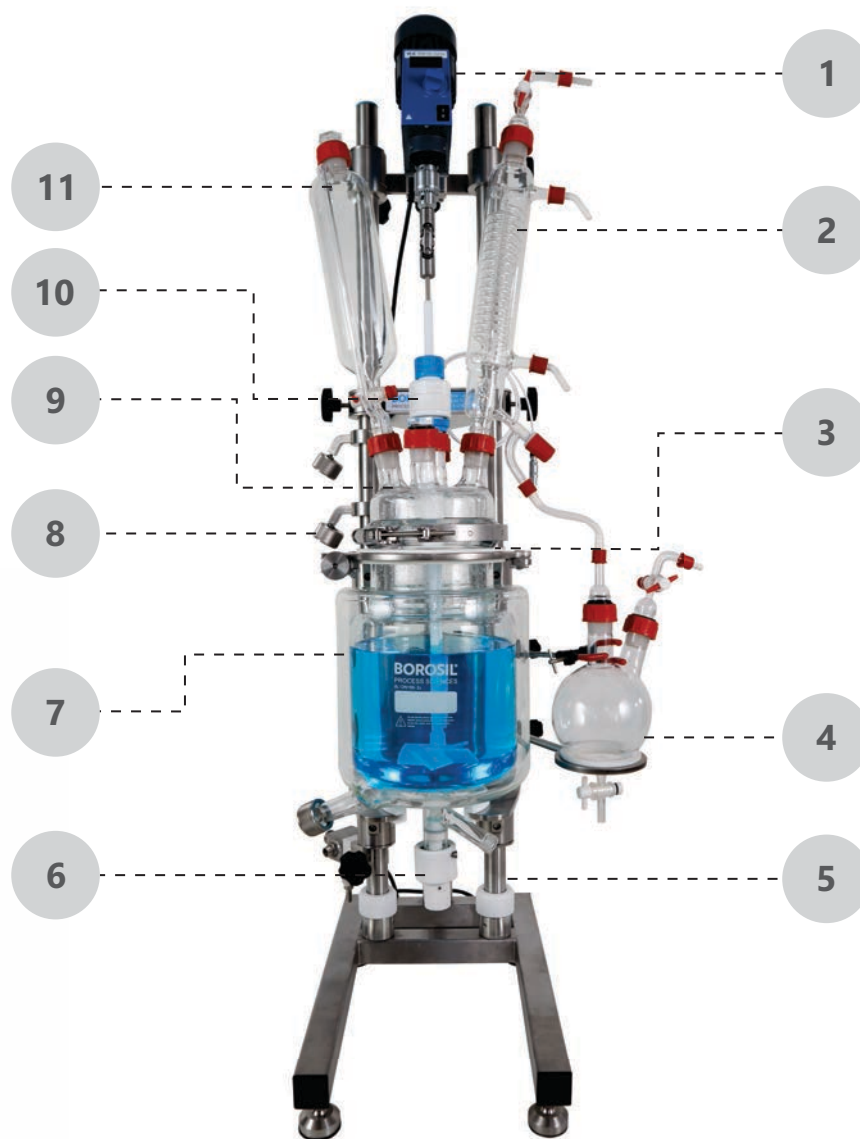

Sr. No.	Description	Qty	Part Code / Ref
1	Agitator Drive	1	Table No. 28
2	Condenser	1	Table No. 5
3	Quick Release Clamp	1	Table No. 10
4	Receiver Vessel	1	Table No. 7
5	Mounting Skid	1	Table No. 12
6	Flush Bottom valve	1	Table No. 13
7	Reactor Vessel	1	Table No. 1, 2
8	Hose Tidy	2	Table No. 11
9	Lid	1	Table No. 3, 4
10	Agitator Accessories	1	Table No. 14
11	Feeding Funnel	1	Table No. 6

Floor Lab Reactor MIDI and Floor Lab Reactor MIDI PILOT are both available with a floor standing skid arrangement and a range of vessels suitable for various applications. The MIDI version offers vessels ranging from 2 L to 5 L, while the MIDI PILOT provides vessels ranging from 10 L to 30 L. Both reactors feature options for single or double jacketed vessels, as well as electric or pneumatic motors, along with other customization options. The skid is made of SS304 for basic applications, with the option for a Teflon-coated skid upon special request.

Floor Lab Reactor MIDI

Assembly Code	Capacity	Temperature °C	Pressure Barg	Flange Dia	L x B x H mm	Jacket
BLMRFLR002XJ000000	2 L	-40 to 200	Full Vacuum to 0.5	DN 150	580 x 510 x 1500	Single/ Double
BLMRFLR003XJ000000	3 L	-40 to 200	Full Vacuum to 0.5	DN 150	580 x 510 x 1500	Single/ Double
BLMRFLR005XJ000000	5 L	-40 to 200	Full Vacuum to 0.5	DN 150	580 x 510 x 1500	Single/ Double

**Customization are available as per requirements.

Floor Lab Reactor MIDI PILOT

Assembly Code	Capacity	Temperature °C	Pressure Barg	Flange Dia	L x B x H mm	Jacket
BLMRFLR010XJ000000	10 L	-40 to 200	Full Vacuum to 0.5	DN 200/300	680 x 510 x 1500	Single/ Double
BLMRFLR015XJ000000	15 L	-40 to 200	Full Vacuum to 0.5	DN 200/300	680 x 510 x 1500	Single/ Double
BLMRFLR020XJ000000	20 L	-40 to 200	Full Vacuum to 0.5	DN 200/300	680 x 510 x 1500	Single/ Double
BLMRFLR025XJ000000	25 L	-40 to 200	Full Vacuum to 0.5	DN 200/300	680 x 510 x 1500	Single/ Double
BLMRFLR030XJ000000	30 L	-40 to 200	Full Vacuum to 0.5	DN 200/300	680 x 510 x 1500	Single/ Double

**Customization are available as per requirements.

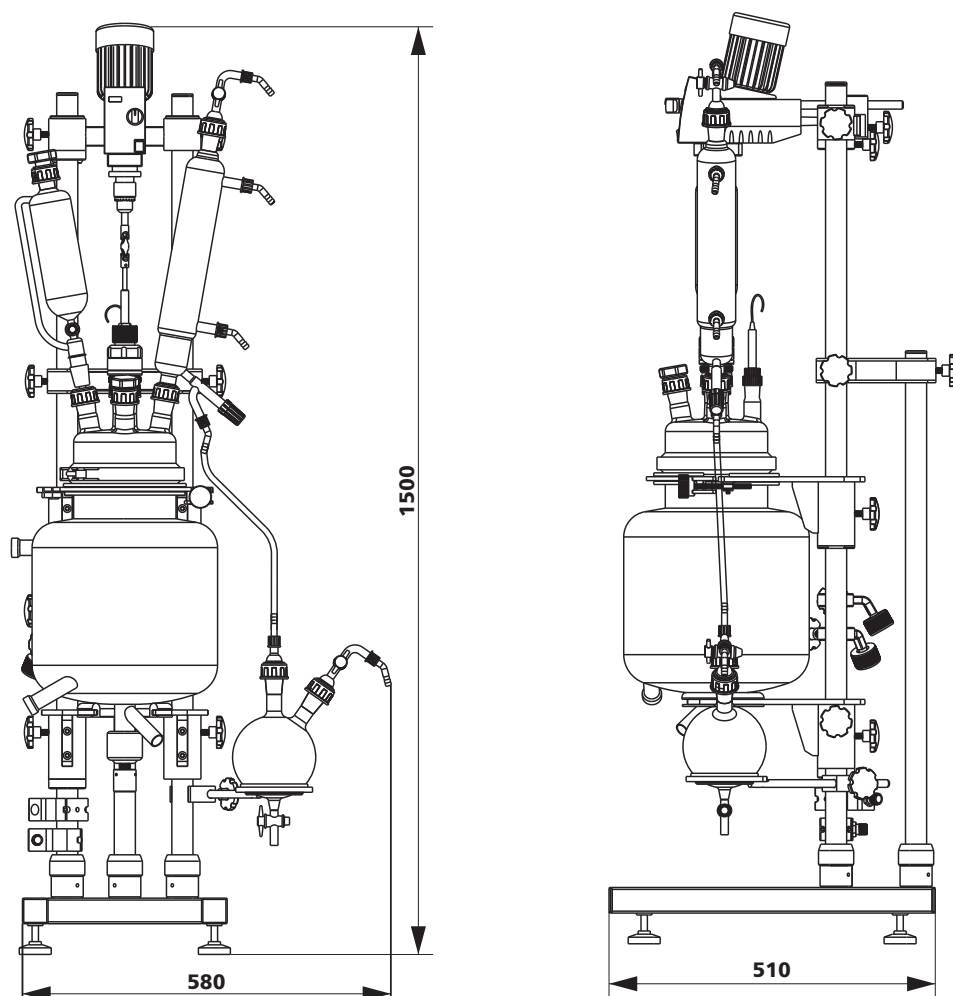

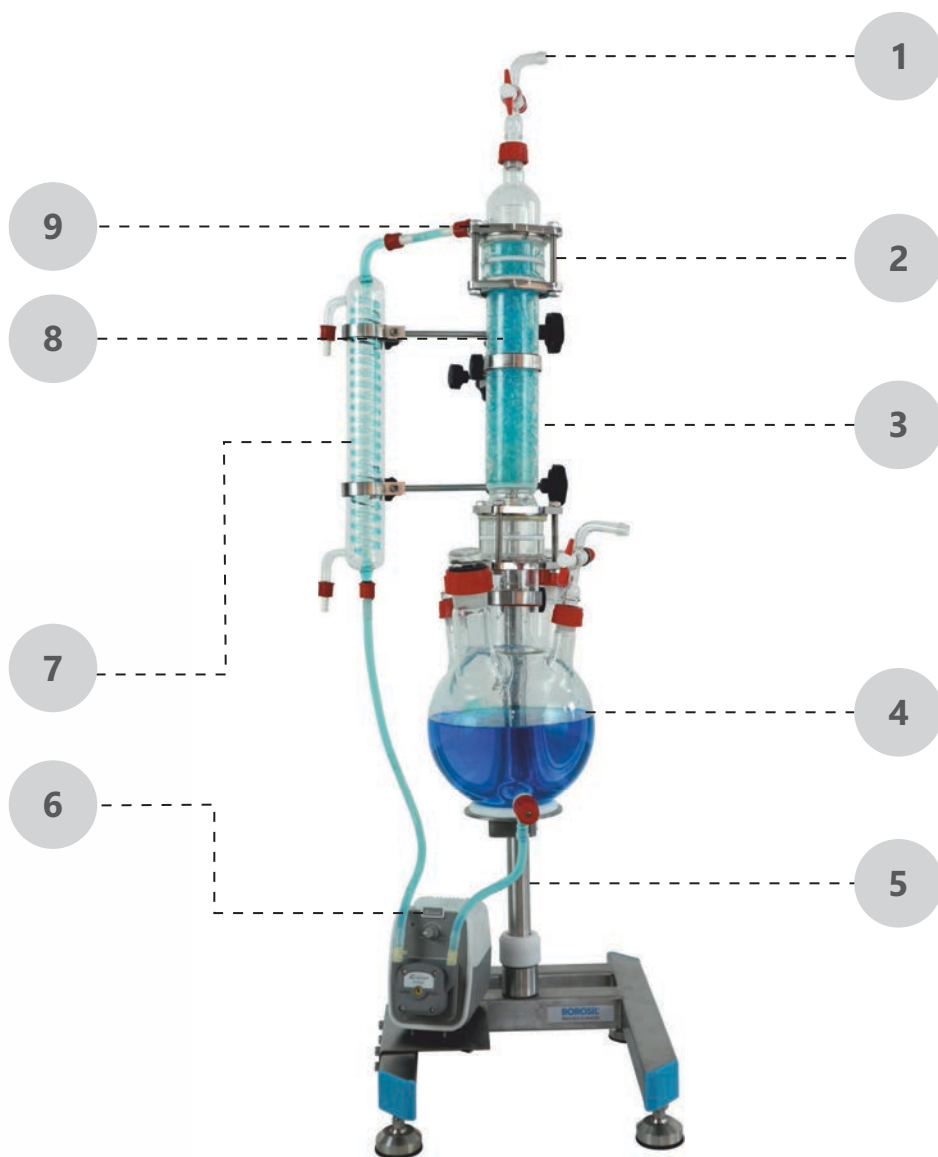

Sr. No.	Description	Qty	Part Code / Ref
1	Gas Vent	1	Table No. 25
2	Shower Head Adaptor	1	Table No. 21
3	Absorption Column	1	Table No. 22
4	Receiver Flask	1	Table No. 7
5	Mounting Skid	1	Table No. 12
6	Circulating Pump	1	BLOODPUMP00000000
7	Cooling Condenser	1	Table No. 23
8	Raschig Rings	1	Table No. 24
9	CT Clamps	2	Table No. 26

Scrubber is available with SS304 tubular skid arrangement and can accommodate 3L, 5L, and 10L. Scrubber is to neutralize harmful exhaust gases by counterflow scrubbing using a suitable reagent. The unit can be used by facilities with stringent work and health safety requirements.

Assembly Code	Capacity	Temperature °C	Pressure Barg	L x B x H mm
BLFRRSC00300000000	3 L	-40 to 200	Full Vacuum to 0.5	320 x 400 x 1200
BLFRRSC00500000000	5 L	-40 to 200	Full Vacuum to 0.5	320 x 510 x 1500
BLFRRSC01000000000	10 L	-40 to 200	Full Vacuum to 0.5	550 x 550 x 1500

**Customization are available as per requirements.

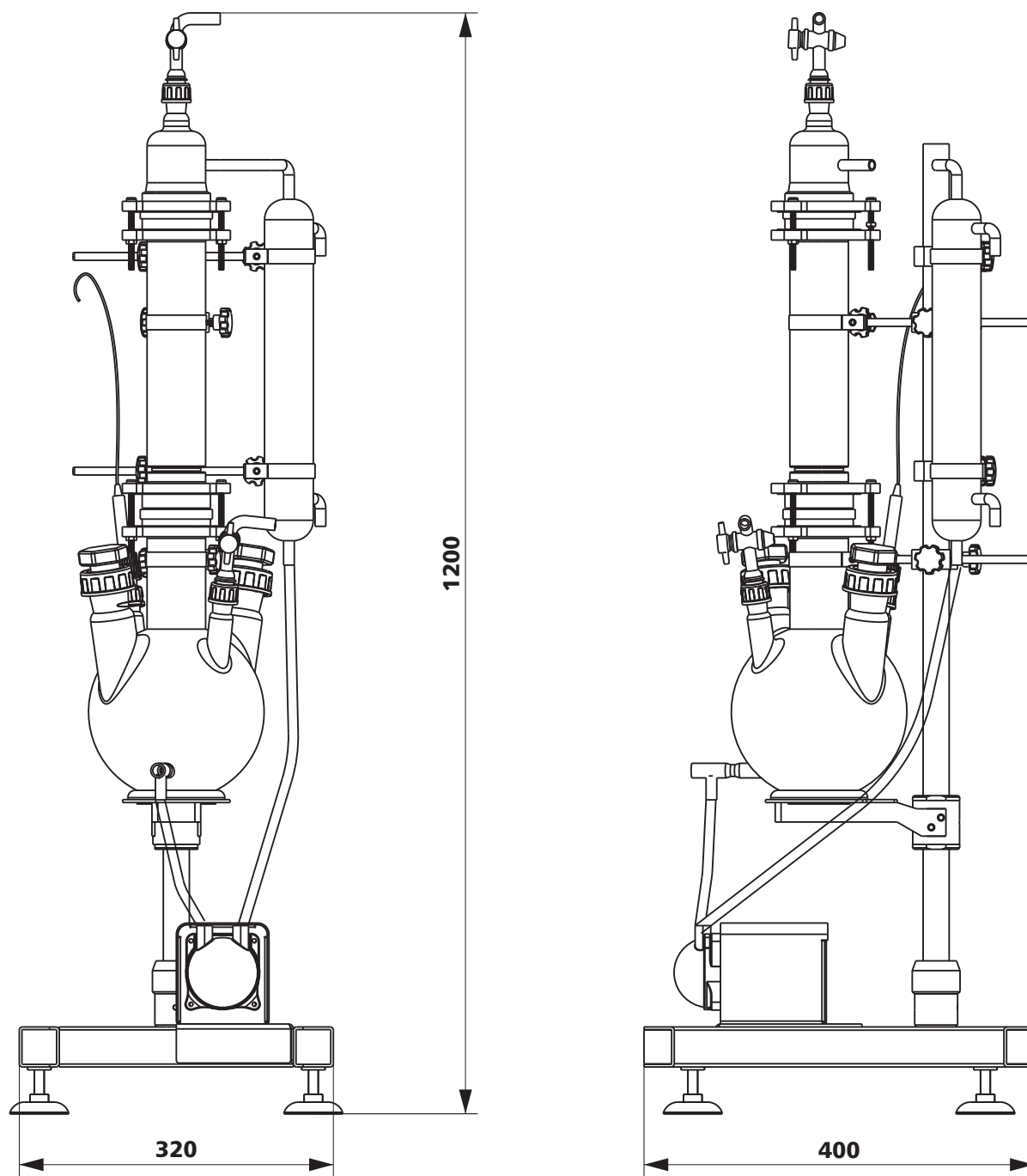

The heating mantle reactor, suitable for reactions ranging from 250 mL to 1 L, provides precise and consistent heating for organic liquid processes like boiling, distillation, and extraction. Its intelligent design ensures safety cutoff and accurate temperature control with various modes for efficient operation.



Technical Data & Ordering Information

Model Name	GMC250	GMC500	GMC001
Flask Capacity	250 ml	500 ml	1000 ml
Working Temperature Range	Ambient +5 °C to 350 °C		
Temperature Accuracy	1°C		
Timer	upto 999 mins or continuous		
Power Requirements	1Å, 150W	1Å, 200W	1.5Å, 300W
Display	LED Display with Temperature, Time and Process Status		
Top Plate Material	MS	MS	MS
Body Construction	MS	MS	MS
Product Dimensions (L x B x H) in mm	310x330x160	310x330x160	310x330x160
Stage wise Heating Modes	Yes	Yes	Yes
External Temperature Probe	PT 100		
Assembly Code	BLFRGMC25000000000	BLFRGMC50000000000	BLFRGMC00100000000

The heating mantle reactor, suitable for reactions ranging from 1 L to 10 L, provides precise and consistent heating for organic liquid processes like boiling, distillation, and extraction. Its intelligent design ensures safety cutoff and accurate temperature control with various modes for efficient operation.

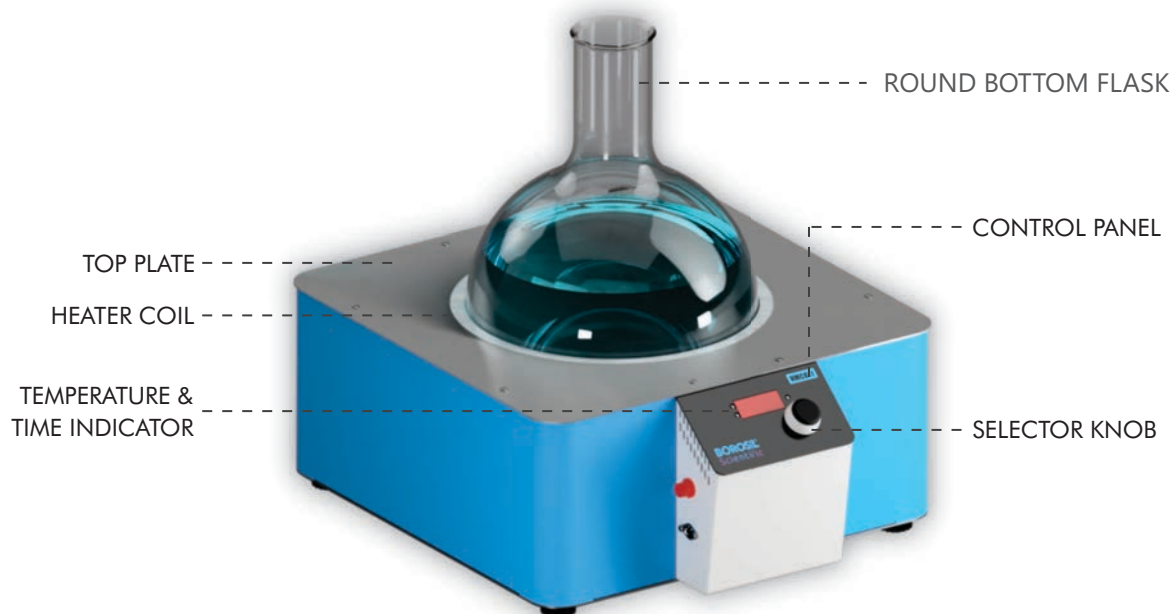

Technical Data & Ordering Information

Model Name	HMC002	HMC005	HMC010
Flask Capacity	2 L	5 L	10 L
Working Temperature Range	Ambient +5 °C to 350 °C		
Temperature Accuracy	1°C		
Timer	upto 999 mins or continuous		
Power Requirements	2.5Å, 450W	3Å, 600W	6Å, 1200W
Display	LED Display with Temperature, Time and Process Status		
Top Plate Material	MS	MS	MS
Body Construction	MS	MS	MS
Product Dimensions (L x B x H) in mm	263x355x136	320x320x260	450x603x215
Stage wise Heating Modes	Yes	Yes	Yes
External Temperature Probe	PT 100		
Assembly Code	BLFRHMC00200000000	BLFRHMC00500000000	BLFRHMC01000000000

ACCESSORIES

REACTOR ACCESSORIES :

Reactor Vessel Single Jacketed - Table No. 1

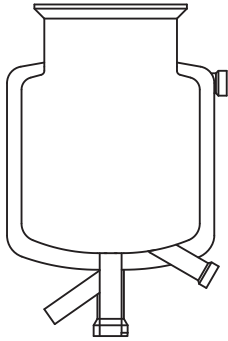

Part Numbers	Capacity (L)	Flange DN (mm)	Jacket	Jacket Capacity (L)	HT Area (sqm)
BLARFLK1TG250100V1	0.25	100	Single	0.3	0.03
BLARFLK1TG500100V1	0.50	100	Single	0.42	0.045
BLARFLK1TG750100V1	0.75	100	Single	0.52	0.048
BLARFLK1TG001100V1	1	100	Single	0.74	0.064
BLARFLK1TG002150V1	2	150	Single	1.45	0.084
BLARFLK1TG003150V1	3	150	Single	2	0.13
BLARFLK1TG005150V1	5	150	Single	3.12	0.14
BLARFLK1TG010200V1	10	200	Single	4.32	0.2
BLARFLK1TG015200V1	15	200	Single	5.62	0.28
BLARFLK1TG020200V1	20	200	Single	10.56	0.4
BLARFLK1TG025200V1	25	200	Single	11.2	0.4
BLARFLK1TG025300V1	25	300	Single	12.2	0.4
BLARFLK1TG030300V1	30	300	Single	13.48	0.42
BLARFLK1TG035300V1	35	300	Single	14.5	0.5

Reactor Vessel Double Jacketed - Table No. 2

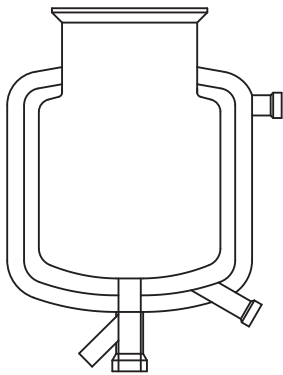

Part Numbers	Capacity (L)	Flange DN (mm)	Jacket	Jacket Capacity (L)	HT Area (sqm)
BLARFLK2TG250100V1	0.25	100	Double	0.3	0.03
BLARFLK2TG500100V1	0.50	100	Double	0.42	0.045
BLARFLK2TG750100V1	0.75	100	Double	0.52	0.048
BLARFLK2TG001100V1	1	100	Double	0.74	0.064
BLARFLK2TG002150V1	2	150	Double	1.45	0.084
BLARFLK2TG003150V1	3	150	Double	2	0.13
BLARFLK2TG005150V1	5	150	Double	3.12	0.14
BLARFLK2TG010200V1	10	200	Double	4.32	0.2
BLARFLK2TG015200V1	15	200	Double	5.62	0.28
BLARFLK2TG020200V1	20	200	Double	10.56	0.4
BLARFLK2TG025200V1	25	200	Double	11.2	0.4
BLARFLK2TG025300V1	25	300	Double	12.2	0.4
BLARFLK2TG030300V1	30	300	Double	13.48	0.42
BLGRFLK1TG035300V1	35	300	Double	14.5	0.5

LID Glass Dome Type - Table No. 3

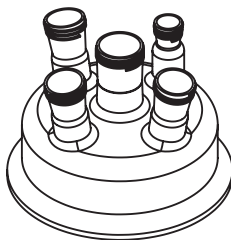

Part Numbers	Flange ID (mm)	No. of Nozzles	Center Nozzle	Side Nozzle	Temperature Sensor Nozzle
BLARLID5FG0DN100V1	100	5	24/29	29/32	19/22
BLARLID5FG0DN150V1	150	5	34/35	29/32	19/22
BLARLID5FG0DN200V1	200	5	34/35	34/35	19/22
BLARLID5FG0DN300V1	300	5	34/35	34/35	19/22

LID PTFE Flat Type - Table No. 4



Part Numbers	Flange ID (mm)	No. of Nozzles	Center Nozzle	Side Nozzle	Temperature Sensor Nozzle
BLARLID5TEFDN100V1	100	5	24/29	M25	M25
BLARLID5TEFDN150V1	150	5	29/32	M30	M40

Condenser - Table No. 5

Part Numbers	Size	HT area	Connection nozzle size
BLARCND000D080L520	D80 LEN 520	0.12	34/35
BLARCND000D065L450	D65 LEN 450	0.08	29/32
BLARCND000D060L320	D60 LEN 320	0.05	19/22
BLARCND000D050L260	D50 LEN 260	0.03	19/22



Feeding Funnel - Table No. 6

Part Numbers	Capacity	Connection nozzle size
BLARDOF11000MLCOCK	1000 mL	34/35
BLARDOF01000MLCOCK	1000 mL	29/32
BLARDOF00500MLCOCK	500 mL	29/32
BLARDOF00250MLCOCK	250 mL	19/22
BLARDOF00100MLCOCK	100 mL	19/22



Receiver Vessel - Table No. 7

Part Numbers	Volume Capacity (mL)	Center Nozzle	Side Nozzles
BLARREF00250MLCOCK	250	19/22	19/22
BLARREF00500MLCOCK	500	19/22	19/22
BLARREF01000MLCOCK	1000	29/32	29/32
BLARREF02000MLCOCK	2000	29/32	29/32



5 Neck Round Bottom Flask - Table No. 8

Part Numbers	Volume Capacity (mL)	Center Nozzle	Side Nozzles
BLARFLK01000ML00RB	1000	24/29	19/22
BLARFLK02000ML00RB	2000	24/29	19/22
BLARFLK03000ML00RB	3000	24/29	19/22 & 24/29
BLARFLK05000ML00RB	5000	24/29	19/22 & 24/29



Integrated Neck Clamp - Table No. 9

Part Numbers	Flange Dia (mm)
BLARCLR00531DN1000	DN100
BLARCLR00531DN1500	DN150
BLARCLR00531DN2000	DN200



Quick Release Clamp - Table No. 10

Part Numbers	Flange Dia (mm)
BLAPCLMPDSS3040106	DN60
BLAPCLMPDSS3040146	DN100
BLAPCLMPDSS3040192	DN150
BLAPCLMPDSS3040250	DN200



Hose Tidy - Table No. 11

Part Numbers	Product	MOC
BLARCLR00523000000	CLR	PEEK & SS
BLARBLR00114000000	BLR	PEEK & SS
BLARFLR00518000000	FLR SERIES	PEEK & SS

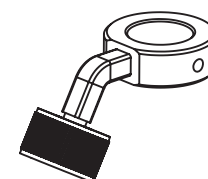

ACCESSORIES

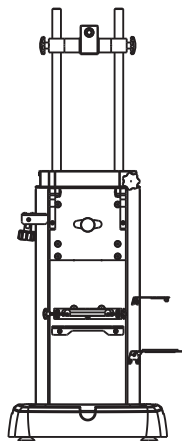

Mounting Skid - Table No. 12

Part Numbers	Product	Volume Capacity	L x B x H (mm)
BLARMLR00510000000	MLR	250 mL to 5L	480 x 300 x 750
BLARBR00510000000	BRS	10 mL to 5 L	230 x 360 x 620
BLARCLR00110000000	miniCLR	250 mL to 1 L	400 x 480 x 1100
BLARCLR00510000000	CLR	2 L to 5 L	500 x 550 x 1300
BLARCLR03010000000	CLR Pilot	10 L to 30 L	700 x 700 x 2600
BLARBLR00110000000	BLR	250 mL to 1 L	320 x 400 x 1250
BLARFLR00510000000	FLR	2 L to 5 L	580 x 510 x 1500
BLARFLR01510000000	FLR	10 L & 15 L	680 x 510 x 1500
BLARFLR03010000000	FLR	20 L to 30 L	750 x 600 x 2000
BLARRSC00310000000	RSC	3 L	320 x 400 x 1200
BLARRSC00510000000	RSC	5 L	320 x 510 x 1500
BLARRSC01010000000	RSC	10 L	550 x 550 x 1500



Flush Bottom Valve - Table No. 13

Part Numbers	Type	MOC	Nozzle Type	Nozzle Size
BLARBT00DN15SL1500	Flush Bottom Valve	PTFE, PEEK	GL Connection	GL 15
BLARBT01DN15SL1500	Flush Bottom Valve	PTFE, PEEK	GL Connection	GL 15
BLARBT00DN25SL1500	Flush Bottom Valve	PTFE, PEEK	GL Connection	GL 25
BLARBT01DN25SL1500	Flush Bottom Valve	PTFE, PEEK	GL Connection	GL 25

AGITATOR ACCESSORIES - Ref. No. 14 :



Universal Guide - Table No. 14.1

Part Numbers	Shaft Dia	Cone Joint Size	Height (mm)	Guide Dia (mm)
BLASTRGUIDE2429D08	8	24/29	110	45
BLASTRGUIDE2429D08	8	24/29	96	45
BLASTRGUIDE2429D10	10	24/29	96	45
BLASTRGUIDE3435D10	10	34/35	96	45
BLASTRGUIDE3435D12	12	34/35	110	55
BLASTRGUIDE3435D16	16	34/35	110	55



Temperature Probe - Table No. 14.2

Part Numbers	Dia (mm)	Length (mm)
BLATEMPROBE200H08D	8	200
BLATEMPROBE300H08D	8	300
BLATEMPROBE400H08D	8	400
BLATEMPROBE500H09D	9	500
BLATEMPROBE600H09D	9	600
BLATEMPROBE700H09D	9	700
BLATEMPROBE900H09D	9	900

Retreat Curve - Table No. 14.3

Part Numbers	Length (mm)	Shaft Dia (mm)	Rotor Type	Rotor Dia (mm)	Blade Ht (mm)
BLASTR0300H08D050R	300	8	Retreat	50	10
BLASTR0300H08D075R	300	8	Retreat	75	15
BLASTR0400H08D050R	400	8	Retreat	50	10
BLASTR0400H08D075R	400	8	Retreat	75	15
BLASTR0400H10D050R	400	10	Retreat	50	10
BLASTR0400H10D075R	400	10	Retreat	75	15
BLASTR0500H10D050R	500	10	Retreat	50	10
BLASTR0500H10D075R	500	10	Retreat	75	15
BLASTR0500H12D125R	500	12	Retreat	125	18

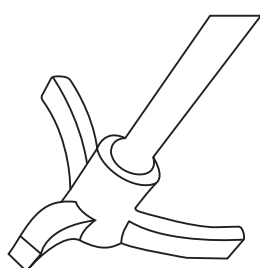

Pitch Blade Turbine Rotor Shaft - Table No. 14.4

Part Numbers	Length (mm)	Shaft Dia (mm)	Rotor type	Rotor Dia (mm)
BLASTP0300H08D040R	300	8	PBT Type	40
BLASTP0400H08D040R	400	8	PBT Type	40
BLASTP0500H08D050R	500	8	PBT Type	50
BLASTP0550H10D070R	550	10	PBT Type	70
BLASTP0650H10D070R	650EX	10	PBT Type	70
BLASTP0750H10D070R	750EX	10	PBT Type	70
BLASTP0650H12D080R	650EX	12	PBT Type	80
BLASTP0750H12D080R	750EX	12	PBT Type	80
BLASTP1000H12D080R	1000EX	12	PBT Type	100
BLASTP0750H12D080R	750EX	16	PBT Type	80
BLASTP0750H16D100R	750EX	16	PBT Type	100
BLASTP1000H16D100R	1000EX	16	PBT Type	100
BLASTP1000H16D120R	1000EX	16	PBT Type	120

**EX - Exposed Length of 50mm.

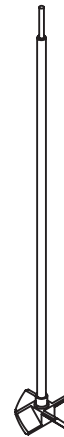

Centrifugal Rotor Shaft - Table No. 14.5

Part Numbers	Length (mm)	Shaft Dia (mm)	Rotor type	Rotor Dia (mm)
BLASTC0300H08D040R	300	8	Centrifugal	40
BLASTC0400H08D040R	400	8	Centrifugal	40
BLASTC0500H08D050R	500	8	Centrifugal	50
BLASTC0550H10D070R	550	10	Centrifugal	70
BLASTC0650H10D070R	650EX	10	Centrifugal	70
BLASTC0750H10D070R	750EX	10	Centrifugal	70
BLASTC0650H12D080R	650EX	12	Centrifugal	80
BLASTC0750H12D080R	750EX	12	Centrifugal	80
BLASTC1000H12D080R	1000EX	12	Centrifugal	80
BLASTC0750H16D080R	750EX	16	Centrifugal	80
BLASTC1000H16D080R	1000EX	16	Centrifugal	80

**EX - Exposed Length of 50mm.

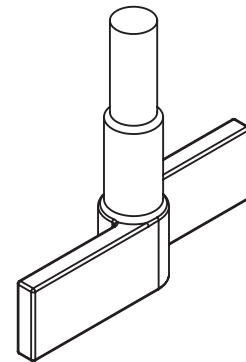

Anchor Rotor Shaft - Table No. 14.6

Part Numbers	Length (mm)	Shaft Dia (mm)	Rotor type	Rotor Dia (mm)
BLASTA0300H08D080R	300	8	Anchor	80
BLASTA0400H08D080R	400	8	Anchor	80
BLASTA0500H08D080R	500	8	Anchor	80
BLASTA0550H10D100R	550	10	Anchor	100
BLASTA0650H10D140R	650EX	10	Anchor	140
BLASTA0750H10D140R	750EX	10	Anchor	140
BLASTA0650H12D140R	650EX	12	Anchor	140
BLASTA0750H12D140R	750EX	12	Anchor	140
BLASTA1000H12D140R	1000EX	12	Anchor	140
BLASTA0750H16D140R	750EX	16	Anchor	140
BLASTA0750H16D180R	750EX	16	Anchor	180
BLASTA1000H16D140R	1000EX	16	Anchor	140
BLASTA1000H16D180R	1000EX	16	Anchor	180

**EX - Exposed Length of 50mm.

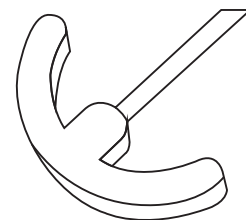

Adjustable Rotor Pitch Blade Type - Table No 14.7

Part Numbers	Shaft Dia (mm)	Rotor type	Rotor Dia (mm)
BLAADJROTPB08D040R	8	PBT	40
BLAADJROTPB10D060R	10	PBT	60
BLAADJROTPB10D090R	10	PBT	90
BLAADJROTPB12D070R	12	PBT	70
BLAADJROTPB12D090R	12	PBT	90
BLAADJROTPB16D100R	16	PBT	100

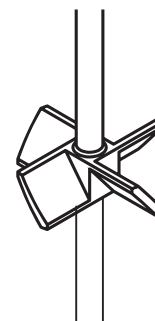

ACCESSORIES

Adjustable Rotor Flat Type - Table No. 14.8

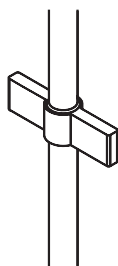

Part Numbers	Shaft Dia (mm)	Rotor type	Rotor Dia (mm)
BLAADJROTFL08D070R	8	Flat	70
BLAADJROTFL10D070R	10	Flat	70
BLAADJROTFL10D100R	10	Flat	100
BLAADJROTFL12D100R	12	Flat	150
BLAADJROTFL16D100R	16	Flat	100
BLAADJROTFL16D150R	16	Flat	150

Drip Tray - Table No. 15

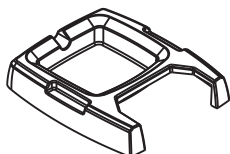

Part Numbers	Product	MOC
BLADRIPTRAYCLR00PP	CLR	FRP
BLADRIPTRAYBLR00PP	BLR	PP
BLADRIPTRAYFLR00PP	FLR SERIES	PP

Solid Dosing Funnel - Table No. 16

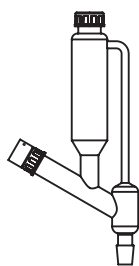

Part Numbers	Volume Capacity	Connection Nozzle Size
BLARSDOF02501922V1	250 mL	19/22
BLARSDOF05001922V1	500 mL	19/22
BLARSDOF05002932V1	500 mL	29/32
BLARSDOF10002932V1	1000 mL	29/32
BLARSDOF20002932V1	2000 mL	29/32
BLARSDOF10003435V1	1000 mL	34/35
BLARSDOF20003435V1	2000 mL	34/35

Bellow Column - Table No. 17



Part Numbers	Height (mm)	ID (mm)
BLARVACBELCOLMN2V1	200	50
BLARVACBELCOLMN4V1	400	50
BLARVACBELCOLMN6V1	600	50

Phase Separator - Table No. 18

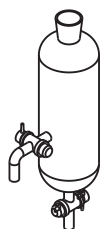

Part Numbers	Capacity	Connection Nozzle Size
BLARPHASESEP0500V1	500 mL	19/22
BLARPHASESEP1000V1	1000 mL	19/22
BLARPHASESEP2000V1	2000 mL	29/32

Heating Block - Table No. 19

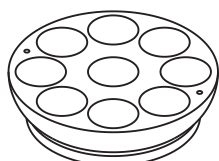

Part Numbers	Position	Capacity
BLARBRS5001P00HTBL	Single	500 mL
BLARBRS0011P00HTBL	Single	1 L
BLARBRS0021P00HTBL	Single	2 L
BLARBRS0031P00HTBL	Single	3 L
BLARBRS0051P00HTBL	Single	5 L
BLARBRS010XP00HTBL	Multi	10 mL
BLARBRS025XP00HTBL	Multi	25 mL
BLARBRS050XP00HTBL	Multi	50 mL
BLARBRS100XP00HTBL	Multi	100 mL
BLARBRS250XP00HTBL	Multi	250 mL

SCRUBBER ACCESSORIES :

Scrubber Vessel - Table No. 20

Part Number	Capacity (L)	No. of Nozzles	Flange ID (mm)	Side Nozzles
BLARREF03000MLSCRB	3	5	50	48/38 (Qty:2), 19/22 (Qty:2)
BLARREF05000MLSCRB	5	5	80	48/38 (Qty:2), 19/22 (Qty:2)
BLARREF10000MLSCRB	10	5	100	48/38 (Qty:2), 19/22 (Qty:2)

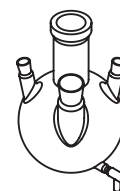

Shower Head Adaptor - Table No. 21

Part Number	Flange ID (mm)
BLARSHW00D050L0300	50
BLARSHW00D080L0500	80
BLARSHW00D100L1000	100

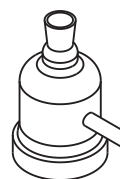

Absorption Column - Table No. 22

Part Number	Flange ID (mm)
BLARCLM00D050L0300	50
BLARCLM00D080L0300	80
BLARCLM00D100L0300	100



Cooling Condenser - Table No. 23

Part Numbers	Length (mm)	Hose Connection
BLARCNDRSCD050L350	350	GL 14
BLARCNDRSCD050L450	450	GL 14



Rasching Rings - Table No. 24

Part Number	OD X L (mm)
BLARFLKCOLRAS00610	6 X 10
BLARFLKCOLRAS00810	8 X 10



Gas Vent - Table No. 25

Part Number	Connection Nozzle Size
BLARADP0BC1922COCK	19/22
BLARADP0BC2932COCK	29/32

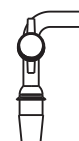

CT Clamp - Table No. 26

Part Numbers	DN	MOC
BLARCTCLMPDN000050	50	SS304
BLARCTCLMPDN000080	80	SS304
BLARCTCLMPDN000100	100	SS304

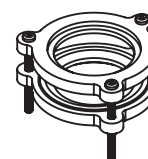

Turnkey Projects

Borosil Process Sciences with its team of System Integrators, Chemical engineers, Mechanical designers, PLC designers, and Glass experts is capable to deliver any sort of pilot system from 25L Kilo Lab to 250L pilot plant scale projects.

We engage closely with our customers and EPC to design the systems. We also coordinate and integrate all kinds of utilities and services ranging from heating and cooling and vacuum systems, electrical systems, power backups and essential civil work.

We deal with wide range of industries, including food, pharma, oil, chemical and many more...

Our process is as follows

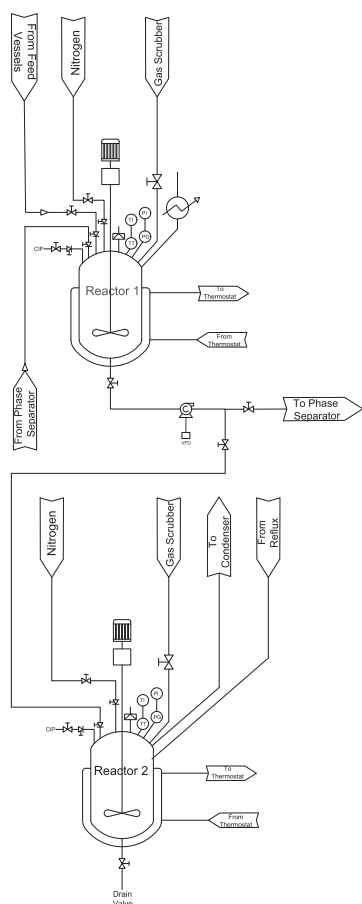
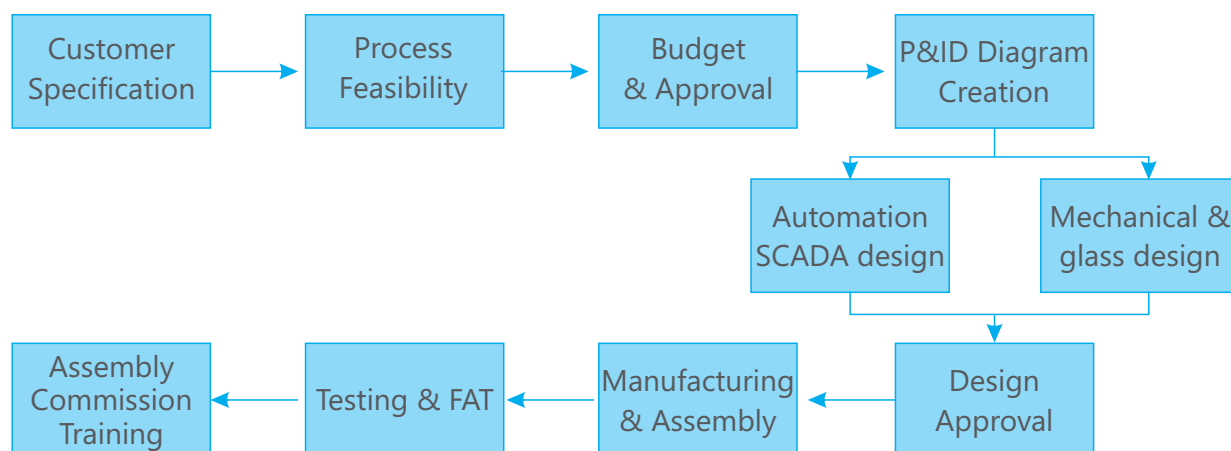

Features :

- Pneumatically operated valves
- Automatic dosing
- Gravimetric dosing
- Single point temperature and flow control
- Pressure and vacuum stability

Applications :

- Vacuum Distillation
- Azeotropic Distillation
- Steam Distillation
- Multi component reactions
- Crystallization
- Extraction of multi phase mixture

Vacuum Pumps - Welch

Vacuum Pumps

Chemically resistant, compact and oil-free diaphragm vacuum pump with manual speed control for adjusting the pump capacity to your specific application. It features a gas ballast, PTFE/TFM heads, PTFE-coated diaphragms and FFPM valves. Suitable for a wide range of Laboratory applications including extremely aggressive/ corrosive gasses and vapors.



Table No. 27

Part Numbers	Pump Model	Absolute Vacuum (mbar)	Capacity (LPM)	Ultimate Vacuum (mbar)
BLAWEL002MPC105T00	MPC 105T IK+EK	2 mbar	20	Without control
BLAWEL010MXPC303Z0	MXPC 303z	5 mbar	30	Without control
BLAWEL002LVS105T00	LVS 105T EF+	2 mbar	20	With Vacuum Control
BLAWEL010LVS210T00	2027	2 mbar	30	With Vacuum Control
BLAWELCNTRLVCPRO60	Vcpro 601			Vacuum Controller

Agitator Drive - IKA

Designed to optimize complex stirring applications, IKA offers the very best in overhead stirrer technology. Our overhead stirrers provide the perfect solution to all of your laboratory stirring and mixing needs, from lower to higher viscosities. IKA overhead stirrers process stirring quantities up to 200 liters. The IKA overhead stirrers also displays temperature of the media.



Table No. 28

Part Numbers	Model	Speed Range (rpm)	Torque (Ncm)	Max Viscosity (mPas)	Max Stirred Volume (L)	Dimensions W x D x H (mm)	Interface
BLAIKARW2000000000	RW20	2000	150	10,000	20	88x212x294	-
BLAIKAMINI20CNTROL	MINISTAR 20 Control	2000	20	10,000	15	70x193x154	RS 232, USB, PT1000
BLAIKAMINI40CNTROL	MINISTAR 40 Control	1000	40	30,000	25	70x147x193	RS 232, USB, PT1000
BLAIKAEUR060CONTRL	EUROSTAR 60 control	2000	60	50,000	40	86x230x267	RS 232, USB, PT1000
BLAIKAEUR100CONTRL	EUROSTAR 100 control	1300	100	70,000	100	86x230x267	RS 232, USB, PT1000
BLAIKAEUR200CONTRL	EUROSTAR 200 control	2000	200	100,000	100	91x209x274	RS 232, USB, PT1000

Heating & Cooling Circulator - HUBER

Successful working of reactor is depends on the right selection of Heating & Cooling Circulator. The quality of temperature control is highly dependent on the speed at which the jacket temperature can be changed. For best possible heat transfer rates, unistats produce a high delta-T between jacket temperature and reactor contents. Glass reactors are inherently sensitive to pressure (typically the maximum allowable jacket pressure is 0.5 bar) and thermal shock (caused by the temperature difference between the jacket and the reaction mass). Unistats have variable pressure control (VPC) and a delta-T limit to protect against both. In addition, the "process safety" function ensures that the pump and cooling system continue to operate in the event of an over temperature shutdown. This can, for example, prevent overheating of the reactor contents during an exothermic reaction



UNISTAT 510



TANGO



UNISTAT 425

Table No. 29

Reactor	Part Numbers	Model	Temp Range °C	Pump Max (L/min, bar)	Heating capacity kW	Cooling capacity kW @ 0 °C	Cooling capacity kW @ -40 °C	Dimensions W x D x H (mm)
Upto 2L	BLAHUBER002MINI230	Ministat 230	-40..200	22, 0.7	1.6 - 2.1	0.38	0.05	255x450x476
	BLAHUBER002TANGO00	Tango	-40..250	55, 0.9	3	0.7	0.06	426x327x631
	BLAHUBER002UNI0705	Unistat 705	-75..250	55, 0.9	1.5	0.65	0.6	425x400x720
5L	BLAHUBER005UNI0405	Unistat 405	-45..250	55, 0.9	3	1	0.15	426x327x631
	BLAHUBER005UNI0705	Unistat 705	-75..250	55, 0.9	1.5	0.65	0.6	425x400x720
	BLAHUBER005UNI0815	Unistat 815	-85..250	40, 0.9	2	1.5	1.4	460x604x1465
10L	BLAHUBER010UNI0425	Unistat 425	-40..250	91, 1.5	2	2.5	0.2	460x554x1453
	BLAHUBER010UNI0815	Unistat 815	-85..250	40, 0.9	2	1.5	1.4	460x604x1465
	BLAHUBER010UNI0825	Unistat 825	-85to250	40, 0.9	3	2.2	2	460x604x1465
20L	BLAHUBER020UNI510W	Unistat 510w	-50..250	112, 0.9	6	5.3	0.9	460x554x1453
	BLAHUBER020UNI0905	Unistat 905	-90..250	48, 0.9	6	3.6	3.5	540x654x1500
30L	BLAHUBER030UNI510W	Unistat 510w	-50..250	112, 0.9	6	5.3	0.9	460x554x1453
	BLAHUBER030UNI912W	Unistat 912w	-90..250	110, 1.5	6	7	6	630x704x1565

Chiller

Our Chillers optimized for condenser cooling and are specially designed to work with Borosil range of condensers.

- Temperature range from -10°C to ambient -5 °C.
- Ergonomic and compact design allows the instruments to be on desk at eye-level.
- Large, bright LED display with reliable temperature control.
- Economic and environmental friendly operation.
- Simple operation and navigation menu.



Table No. 30

Model	Recirculating Chiller CHL 175	Recirculating Chiller CHL 500	Recirculating Chiller CHL 010
Part Numbers	BLFRCHL17500000000	BLFRCHL50000000000	BLFRCHL01000000000
Description	Recirculating Chiller, Positive Displacement Pump, -10 to 40°C, 1/4 hp; 240 VAC, 50 Hz	Recirculating Chiller, Positive Displacement Pump, -10 to 40°C, 1/4 hp; 240 VAC, 50 Hz	Recirculating Chiller, Positive Displacement Pump, -10 to 40°C, 1/4 hp; 240 VAC, 50 Hz
Reservoir Material	SS304 Tank	SS304 Tank	SS304 Tank
Reservoir Capacity (L)	5 L	7.5 L	10 L
External Dimensions (mm)	508X257X596	594X327X596	594X396X723
Max Temperature (°C)	40	40	40
Min Temperature (°C)	-10	-10	-10
Cooling Capacity @0°C (watts)	105	300	600
Cooling Capacity @10°C (watts)	140	400	800
Cooling Capacity @20°C (watts)	175	500	1000
Pump Type	Positive displacement	Positive displacement	Positive displacement
Pump Power	60W	60W	60W
Compressor Horse Power(W)	155	200	455
Port Connections -Pipe	10mm ID	10mm ID	10mm ID
Power (VAC)	240	240	240
Power (Hz)	50	50	50
Mobility	Benchtop Model	PU Wheels	PU Wheels
Self Diagnostic Function	Identifies Temp/Probe Errors	Identifies Temp/Probe Errors	Identifies Temp/Probe Errors

BOROSIL[®] Scientific

Industrial Scientific Process Glass Equipments,
Components & Spares



The Transparent Specialist

A BOROSIL SCIENTIFIC Company

PIPELINE COMPONENTS



GLASS VALVES



CONDENSERS



SHELL & TUBE HEAT EXCHANGER



COLUMN COMPONENTS



GLASS COLUMN



PIPELINE COMPONENTS



COLUMN PACKING
RASCHIG RINGS



VESSELS



PACKING SUPPORT



STIRRING ASSEMBLY



PTFE STIRRERS



COUPLINGS &
GASKETS



COUPLINGS &
GASKETS



STRUCTURE &
SUPPORT



Standard Units

Glass Reactor with Metal Jackets

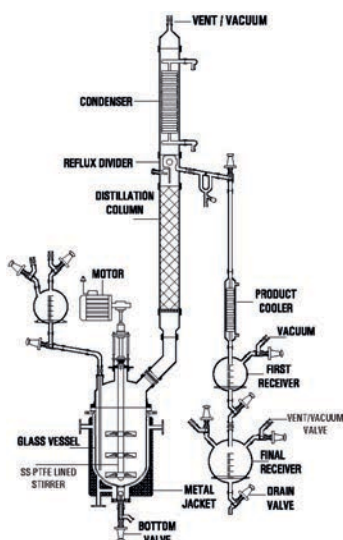

Glass Metal jacketed Reactor 5-200 liter
Pressure: - up to 1 Bar
Temperature: -50°C to +200°C
Material: Borosilicate glass 3.3 /PTFE/ SS 316.

Simple Distillation Unit

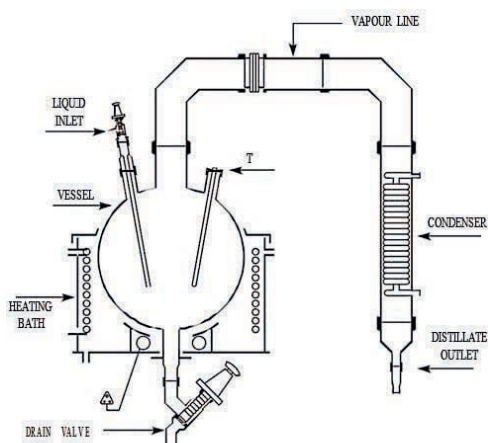

The units are available in vessel sizes of 20, 50, 100, 200, 300 & 500 L and is suitable for operation under atmospheric pressure and full vacuum.

Reaction Unit

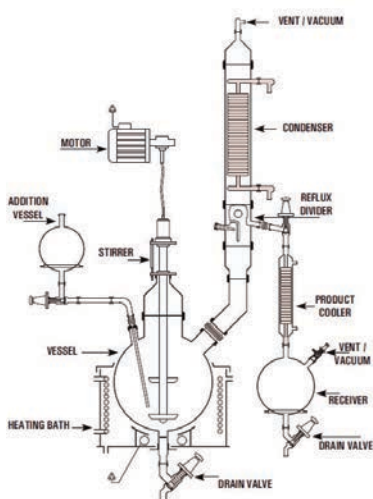

The units are available in vessel sizes of 20, 50, 100, 200, 300 & 500L and is suitable for operation under atmospheric pressure and full vacuum.

Fractional Distillation Unit 20 L to 500 L

Reaction Distillation Unit 20 L to 500 L

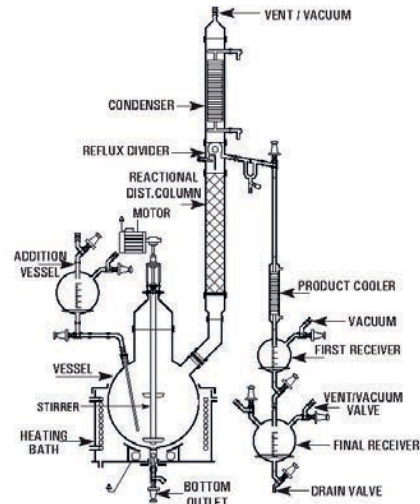
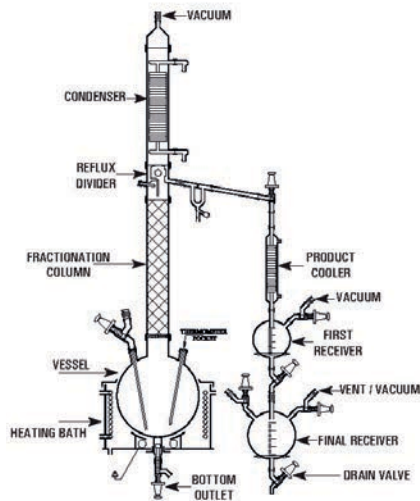

Liquid Extraction Unit 20 L to 300 L

Solid Liquid Extraction Unit 20 L to 300 L

Liquid Liquid Extraction Unit 20L to 300L

Solid Liquid Extraction Unit 20L to 300L

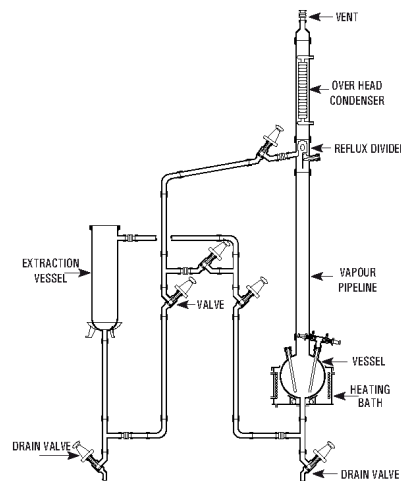
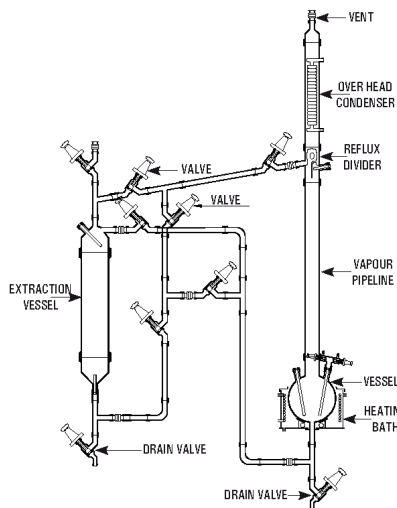

Gas Scrubber 20 L to 300 L

Assemblies Over Glass Lined Reactor

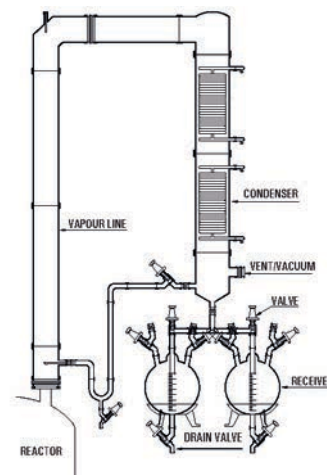
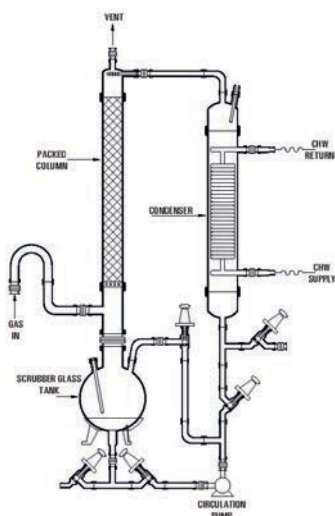

Essential Oil Distillers 10L to 200L

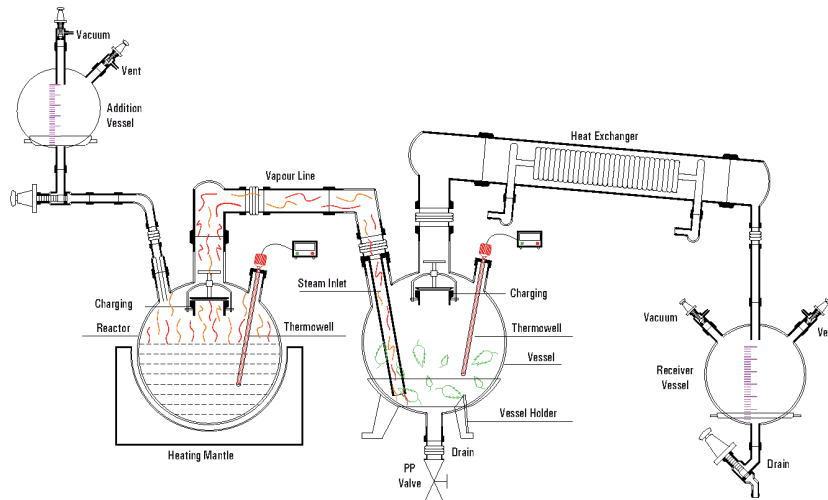

Multi Purpose Unit 20L to 300L

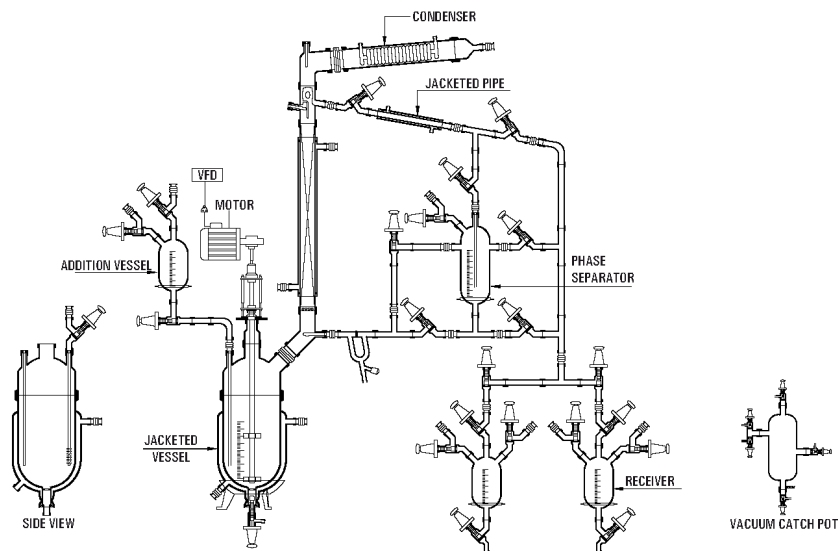

HCL Adiabatic Absorption

Jacketed Mixing Reactor upto 300L

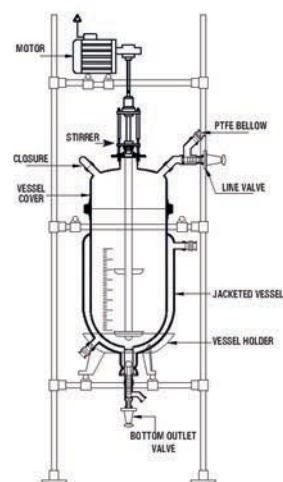
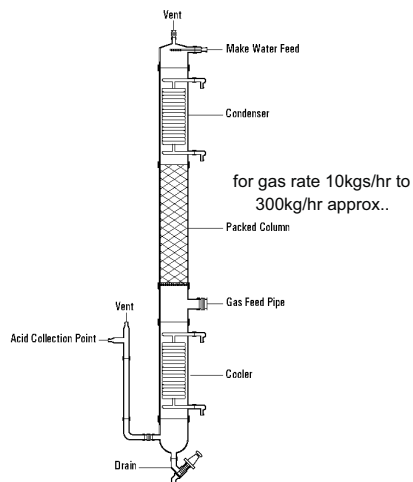

High Pressure Glass Reactor (0.5Ltr to 10 Ltr)

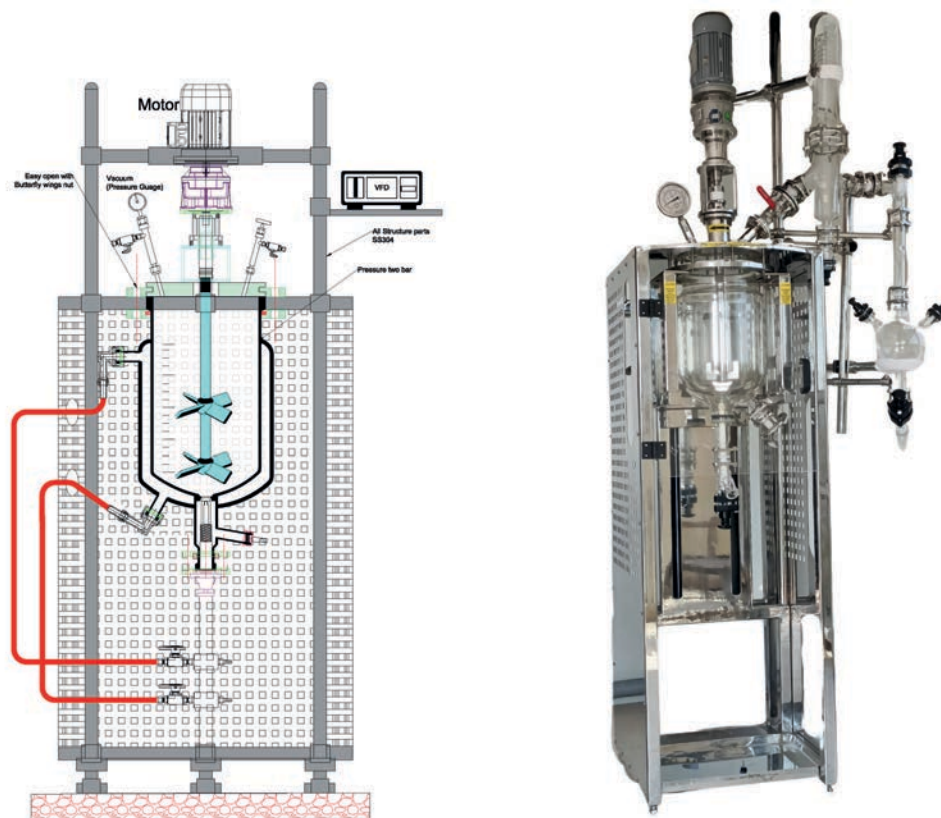

Operating Jacket Pressure Up to +0.5 barG (0.05 MPa)

*Automation on Request

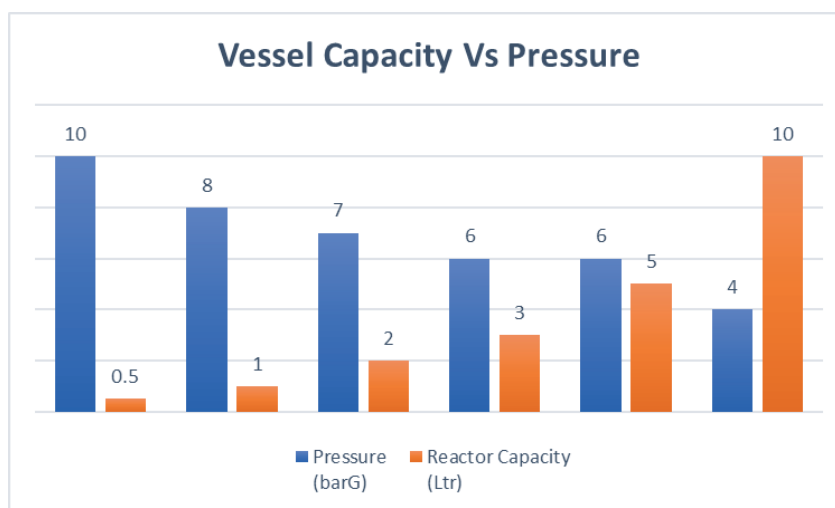

A high-pressure glass reactor is a specialized vessel designed for chemical reactions under elevated pressure, achieved by the reaction itself or externally supplied sources like hydrogen. Operating at temperatures above solvent boiling points, these reactors impact reaction dynamics by increasing concentration and collision frequency among molecules, accelerating reactions.

Agitated Glass Nutsche Filter/ Peptide Synthesizer 10L to 300L



Rotary Evaporator 5L to 100L



Jumbo Rotary Evaporator 200L to 800L

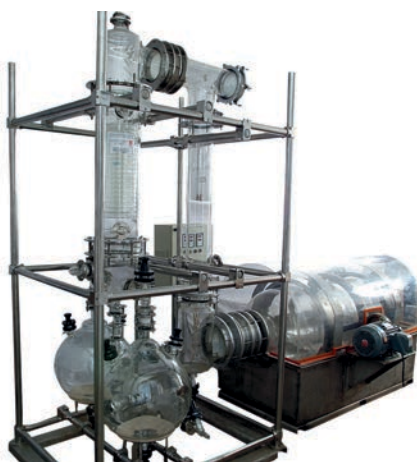

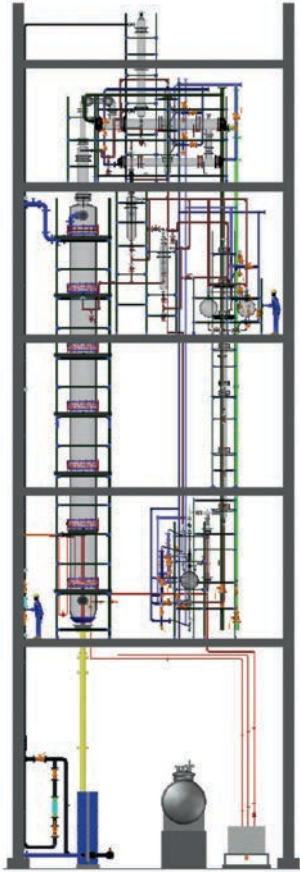

BROMINE RECOVERY UNIT

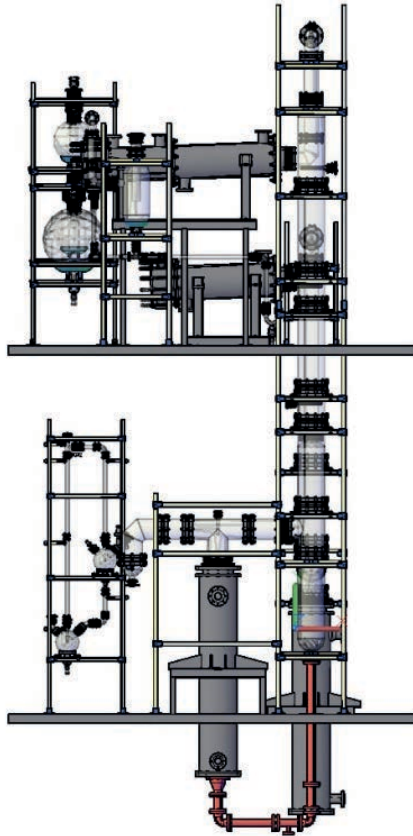

HCL GAS GENERATOR

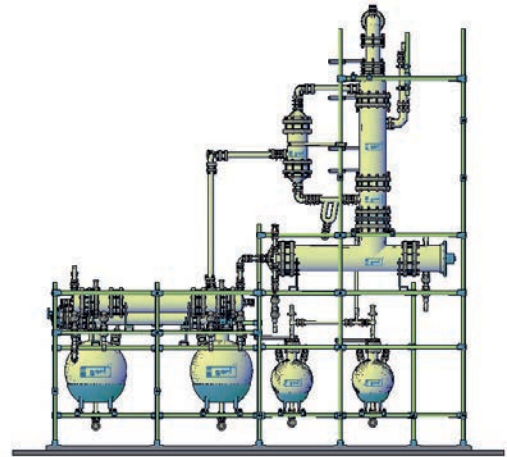

SULFURIC ACID CONCENTRATION SYSTEM

1. Absorption systems for gases such as HCl, Cl₂, SO₂, HBr, NH₃, Br₂, NO_x etc
2. Anhydrous HCl Gas Generation Unit by different routes viz.
 - Sulphuric Acid
 - Boiling Route
 - Calcium Chloride Route
 - Cyclic Route
3. HBr Gas Generator (By Boiling Route)
4. Sulphuric Acid Dilution Units
5. Hypochlorite Manufacturing Units
6. MCA Condensation Assembly
7. Distillation - Conversion of Batch Process to continuous Process
8. Solvent Recovery
9. Iodine Recovery
10. Raw DCB Plant
11. Falling Film Evaporator
12. Wiping Film Evaporator
13. Bromine Recovery System
14. Rotating Disk Extraction Column
15. Precision Metals Refining
16. Nitric Acid Purification System
17. HCL Purification System



CUSTOM GLASSWARE

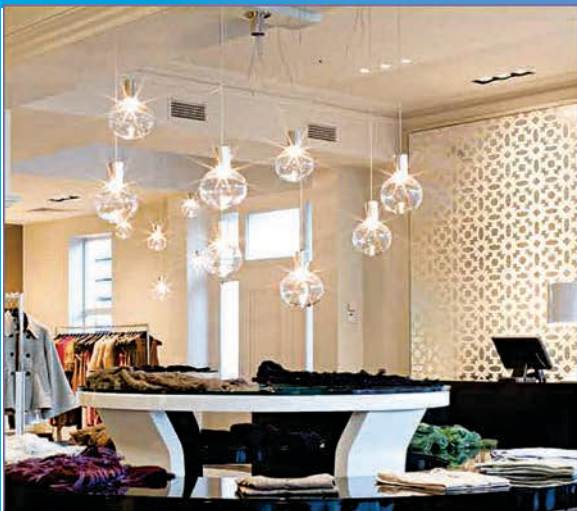

Besides the manufacturing of our standard glass components, we specialize in producing borosilicate glassware as per customer requirement. For any components, which are not in our range of standard production, we can fabricate the same as per required drawing or sample. Our experienced glass blower team can assist

drawing or sample. Our experienced glass blower team can assist you in designing of any components as per client requirement.

As a part of our super speciality - The one of the Indigenous segment that is CUSTOMIZED GLASSWARE.

TECHNICAL INFORMATION

BOROSIL LOW EXPANSION BOROSILICATE GLASS:

From the 16th century to the present day, chemical research teams have been using glass containers for a very simple reason. As the glass container is transparent, the contents and the reaction are clearly visible. However, since chemists need to heat, cool and mix chemical substances, ordinary glass is not always appropriate for laboratory work.

Laboratory work requires apparatus made of glass that can readily be moulded into any desired shape or form. It requires glass that offers maximum inertness when in contact with the widest range of chemical substances. The glass should have the capability to withstand thermal shock without fracture, and it should facilitate high temperature work without deforming. It should be resilient enough to survive the everyday knocks to which it will be subjected in normal laboratory handling, washing and sterilising processes.

BOROSIL is the trade name of such a glass.

The products represent optimum mechanical, thermal and chemical behaviour. This glass is used in laboratories as well as for industrial applications, where thermal shock resistance, mechanical resistance as well as unusual chemical resistance are required.

CHEMICAL COMPOSITION OF GLASS

Borosil glass is a 3.3 Type I low alkali borosilicate glass. It is virtually free from the Magnesia-Lime-Zinc group, and is also completely free of arsenic and other heavy metals. Its **typical chemical composition** is given below.

Content	Approx % by weight
SiO ₂	81
B ₂ O ₃	13
Na ₂ O / K ₂ O	4
Al ₂ O ₃	2

THERMAL PROPERTIES

Borosil glass has a low co-efficient of thermal expansion. Consequently, the thermal stresses under a given temperature gradient are also low. The glass can withstand

higher temperature gradients and also sudden temperature changes / thermal shocks. Minute scratching of the glass surface can, however, reduce its thermal resistance. 'Strain Point' should be regarded as the maximum safe operating temperature for Borosil glassware. When heated above 500°C, the glass may acquire permanent stresses on cooling.

All Borosil laboratoryware is annealed in a modern Lehr, under strictly controlled conditions to ensure minimal residual stresses in the products.

The **typical thermal properties** of Borosil glassware are mentioned below

Coefficient of Linear Expansion	2.5 x10⁻⁷cm / cm / °C
Strain Point	515°C
Annealing Point	565°C
Softening Point	820°C
Specific Heat	0.2
Thermal Conductivity (Cal / cm ³ / °C / sec)	0.0027

CHEMICAL PROPERTIES

BOROSIL 3.3 Glass is highly resistant to water, neutral and acid solutions, concentrated acids and acid mixtures, and to chlorine, bromine, iodine and organic substances. The chemical resistance of this glass is superior to that of most metals and other materials, even when exposed to long processing periods and temperatures above 100 °C. A slight release of mainly monovalent ions takes place after exposure of the glass to water or acids. A very thin layer of impervious silica gel is subsequently formed on the surface of the glass, which in turn slows down further attack. At higher temperatures and in more concentrated forms the glass surface is subject to increased attack by hydrofluoric acid, hot phosphoric acid and alkaline solutions.

Hydrolytic Class (ISO 719)	HGB 1
Acid Class (DIN 12 116)	S1
Alkali Class (ISO 695)	A 2

A GUIDE ON GLASS BREAKAGE AND RECOMMENDED SOLUTIONS

Type of breakage	Causes of glass breakage	Solution
Breakage during heating procedures	Drying up of vessel during heating due to evaporation	Do not leave the vessel unattended during heating procedure
	Use of excessive heat throughout the experiment	Decrease the temperature as the liquid level drops
	Use of point source heating	Solution Use a large but soft flame for heating
	Heating of the vessel above the liquid level	"Ensure that the flame is in contact with the vessel below the liquid level"
	Uneven heating the vessel over electric heaters and hot plates; use of an under sized hot plate	"Always ensure that the surface of the hot plate is larger in area than the base of the vessel being heated."

A GUIDE ON GLASS BREAKAGE AND RECOMMENDED SOLUTIONS

Type of breakage	Causes of glass breakage	Solution
Breakage during cooling procedures	Placing the hot vessel on cold surface/ filling up a hot vessel with cold liquids	Allow the vessel to cool before placing or filling it up on/ with cold surfaces/substances
Breakage due to scratches and abrasions inside the vessel	Use of incorrect anti-bumping device, such as broken porcelain with sharp edges that causes internal abrasions and reduces mechanical strength of the glass	Always use anti-bumping devices in the vessel, such as powdered pumice or glass wool
	Use of improper stirring device that causes internal abrasions and reduces mechanical strength of the glass	Always use a teflon sleeve or a similar device on stirring rods, to prevent scratching of the inside of the vessel
		When using a glass vessel with a magnetic stirrer, always use a covered follower. This prevents abrasion of the walls from inside of the vessel
Breakage of the base of the glass container	Placing the hot vessel on cold surface/ filling up a hot vessel with cold liquids	Allow the vessel to cool before placing or filling it up on/ with cold surfaces/substances
	Use of a glass or metal mechanical stirrer in a glass vessel	Always pre-determine the height of the stirrer before use, to ensure that the stirrer blade does not come in contact with the base or sides of the vessel
	Addition of the antibumping device from a height in the glass vessel	
	Addition of water to acid in a glass vessel which generates sudden heat and leads to breakage	Always ensure to add water first in the glass container followed by slow addition of acid
Breakage due to vacuum/ pressure	Application of sudden pressure changes	Apply and release positive or negative pressures gradually.
	Use of pressure beyond the limit	Refer manufacturers instructions carefully before applying pressure/ vacuum to the glass vessel
Breakage of stopcocks and joints	Stopcocks stuck hardly on burettes and funnels	When not in use insert a thin strip of paper between the joint surfaces to prevent them from sticking
		Mechanical separation of the joint by carefully rocking the Cone in the socket, or gentle tapping the socket flange on a wooden surface, or by heating the socket and not the Cone in a localised flame
		Use of penetrating oil
		Frequent lubrication to prevent the stopcock and joints from sticking
		When using lubricants, it is advisable to apply a light coat of grease all around the upper part of the joint. Use only a small amount, and avoid greasing the part of the joint that comes in contact with the inside of the apparatus. Three types of lubricants are commonly used on standard taper joints. (a) Hydrocarbon grease is the most widely used. It can be removed easily by most laboratory solvents, including acetone. (b) As hydrocarbon grease is easy to remove, silicon grease is usually preferred for higher temperature or high vacuum applications. It can be removed with chloroform easily. (c) For long-term reflux or extraction reactions, a water-soluble, organic and insoluble grease such as glycerin, is suitable. Glycerin can be removed by means of water
Breakage during inserting glass tubing into rubber bung	Improper lubrication	Use water, oil or glycerol on both, the tubing as well as the rubber bung
	Presence of rough ends	Always fire-polish the rough ends of the glass tubing before attempting to insert it into flexible tubing

CLEANING OF GLASSWARE

Use of clean glassware is crucial for efficacy and efficiency of chemical reactions or biological processes. It is the key to success of any experiment. Use of dirty glass ware can lead to cross contamination of chemicals thereby leading to erroneous results. Cleaning of glassware should be an integral part of the good laboratory practices and should be followed by each member of the lab after each use.

DID YOU KNOW ?

New glassware is slightly alkaline in reaction. Hence, it should be soaked for about 2 to 3 hours in acidic water (1% solution of hydrochloric acid or nitric acid). Rinse with water and then soak the empty glassware in a basin / tub containing suitable cleaning agent / solution for 20 to 30 minutes.



Cleaning agents :

- Water/Purified water/warm water – Routine cleaning of all glassware
- Soaps/ detergent solution - Routine cleaning of all glassware
- Cleaning powders with/without abrasives – For exceptionally dirty glassware
- Acetone/Solvents - Glassware with greasy, sticky, waxy materials and glassware containing water immiscible solvents
- Hot nitric acid – glassware containing cloudy precipitates and coagulated organic matter, glassware required for TOC analysis

NOTE : After use of any of the cleaning agents, other than water, glassware should be rinsed and cleaned with water as per the standard laboratory procedure

DO'S AND DON'TS OF CLEANING

DO'S	DON'T'S
Remove the content of glassware before washing	Do not use a metallic scrubber or a brush with metallic bristles for cleaning
Remove all markings / sticker labels from the glassware.	Do not use strong alkalis for cleaning
Bring glassware to ambient temperature before cleaning, if they are subjected to heating or cooling during analysis	Do not use chromic acid and sulphuric acid mixture for cleaning as it is hazardous and toxic in nature
Use a suitable cleaning agent depending upon the type of dirt	
Soak the glassware in the cleaning agent for about half an hour before cleaning	
Use a good quality brush for cleaning	
After applying the cleaning agents always rinse the glassware first with tap water and finally with purified water	
Recommended temperature for drying of glassware is 60°C - 100°C	

Pipette Cleaning

- Dip the pipettes with their tips down, in a cylinder or tall jar of water, immediately after use.
- Do not drop them into the jar as this may break or chip the tips and render them useless.
- A pad of cotton or glass wool at the base of the jar will help to prevent breaking of the tips.
- Please ensure that the water level is high enough to immerse the greater portion of all or each of the Pipettes.
- Then drain the Pipettes and transfer them into a cylinder or jar containing any suitable cleaning agent or any suitable detergent solution.
- Allow it to soak in a jar or cylinder for about half an hour.
- Drain the pipette and run tap water over and through them until all contents are removed.
- Soak the Pipettes in purified water for at least one hour.
- Remove them and dry the external surface with a cloth, shake out the water and dry in oven.
- After drying, place the Pipettes in a dust-free drawer.
- For sterile applications, wrap serological and bacteriological Pipettes in an autoclavable bag and autoclave at 121°C for 30 mins or place them in
- Pipette cans and sterilise them in the dry air steriliser at 160°C for two hours.
- A Pipette used for transferring infectious material should have a plug of cotton placed in its mouth end before sterilising

Burette Cleaning

- Remove stopcock key before cleaning and wash the stopcock key separately
- Wash the burette with suitable cleaning agent or any other suitable detergent solution
- Rinse with tap water until all the dirt is removed. Then rinse with purified water.
- Keep the cleaned burette in inverted position until dry.
- Open the stopcock and keep for drying.
- Before the stopcock key is replaced in the burette, lubricate the joint with a small amount of lubricant.
- Always cover tip of burettes with butter paper or aluminium foil, when not in use.

Note: **The burette stopcock keys and glass stopcocks are not interchangeable**, hence, glass key and burette bore should be marked properly to avoid mix-ups

Culture Tubes

- Culture tubes which have been used previously must be sterilized before cleaning. The best general method for sterilising culture tubes is by autoclaving for 30 minutes at 121°C (15 lb pressure). Media which solidify on cooling should be poured out while the tubes are hot.
- After the tubes are emptied, brush them with a suitable cleaning agent.
- Rinse thoroughly with tap water, rinse with purified water, shake out the water and dry in oven.
- After cleaning before the next use, the culture tubes need to be sterilized again.
- The culture tubes and culture medium can be sterilized together in one cycle or can be sterilized separately.
- In the latter case, the sterile medium can be filled in the sterile culture tubes aseptically.

Serological Tubes

- Serological Tubes should be chemically clean but need not be sterile. However, specimens of blood which are to be kept for some time at room temperature should be collected in a sterile container. It may be expedient to sterilize all tubes as routine.
- To clean and sterilize tubes containing blood, discard the clots in a waste container and place the tubes in a large basket.
- Put the basket with others, in a large bucket or boiler. Cover with water, add a fair quantity of soft soap or suitable cleaning agent and boil for 30 minutes. Rinse the tubes and clean with brush, rinse and dry with the usual precautions.

Note: It is imperative when washing serological glassware that all acid, alkali and detergent be completely removed. Both acid and alkali in small amounts destroy complement and in larger amounts produce haemolysis. Detergents interfere with serologic reactions.

Serological tubes and glassware should be kept separate from all other glassware and used for nothing except serologic procedures.

Microscope Slides

Cleaning of New slides

- Put a drop of cleaning solution of the slide. This can be a detergent solution or diluted alcohol solution
- Apply the cleaning solution uniformly on both the sides of slide and clean the surface carefully with your fingers or using a lint-free microfibre towel
- Rinse thoroughly under running tap water until the cleaning solution is completely washed out
- Ideally a thoroughly cleaned slide should hold a layer of water uniformly over its surface. This indicates that the slide is cleaned properly. If the water layer is formed over the surface in blotches, repeat the cleaning
- After cleaning is done dry slide using a paper towel/ microfibre towel.
- Allow the slides to air dry for some time before using

Cleaning Used slides

- Place the used slide in a container full of warm water and detergent
- Leave the slide in this for at least 0-8 hours
- Clean the slide using a gauze by rubbing both the sides until they are free of the dirt, stains, oil, etc.
- Rinse thoroughly under running tap water until the cleaning solution is completely washed out
- Ideally a thoroughly cleaned slide should hold a layer of water uniformly over its surface. This indicates that the slide is cleaned properly. If the water layer is formed over the surface in blotches, repeat the cleaning
- After cleaning is done dry slide using a paper towel/ microfibre towel
- Allow the slides to air dry for some time before using

Recalibration of volumetric glassware

Abstract: ASTM Standard E 452-01, Clause 4.2

3.3 low expansion borosilicate volumetric glassware will hold its calibration indefinitely provided that it is not exposed to hydrofluoric acid, phosphoric acid, or strong, hot alkalis, and that it is not heated above 150°C when dry. A frosting of the glass surface (when viewed dry) indicates that chemical attack has occurred and recalibration may be in order. As a precaution, however, it is recommended that the glassware be recalibrated after 10 years of service regardless of its appearance.

AUTOCLAVING OF GLASSWARE

Autoclaves are widely used to sterilise instruments, glassware and plasticware, solutions and media, and to decontaminate biological wastes. Due to the physical hazards (e.g. heat, steam and pressure) associated with autoclaving, extra care must be taken to use them safely. Each autoclave has unique characteristics and operating requirements. Please review and understand the owner's manual before using any autoclave for the first time, and every time thereafter. Also, please follow all the safety regulations for autoclaving, laid down by your institution.

Autoclaving empty glassware

1. Place individual glassware vessels within a heat resistant plastic or metal tray on a shelf or rack.
2. Never place them directly on the autoclave base or floor
3. Always maintain space (>5 cm) between glass vessels to give them room to expand while heating, and to prevent them from hitting other vessels when entering or leaving the autoclave
4. Add water rising up to 1/4 to 1/2 inch in the tray, so that the glassware will heat more evenly
5. Large heavy glassware, such as 3L or larger spinner flasks 5L or larger bottles and carboys should have a small amount of distilled water placed inside them to help generate steam when they are being sterilised dry in an autoclave

Autoclaving glassware containing liquids

Never autoclave items containing corrosives (e.g. acids, bases, phenol), solvents or volatiles (e.g. ethanol, methanol, chloroform) or radioactive materials.

1. Fill the glassware only half full with the liquids to be sterilised.
2. Take into consideration, the volume of liquid to be autoclaved.
For e.g. : 2-litre flask containing 1 litre of liquid takes much longer to sterilise than four 500 ml flasks, each containing 250 ml of liquid
3. Do a test run when autoclaving larger volumes of liquid, to make sure that the liquid has reached 121°C
4. Always use the slow exhaust or liquid cool cycle when autoclaving liquids, to prevent the liquid from boiling over, causing loss of the contents
5. Suspend an autoclave thermometer with a thin wire, in the middle of the liquid-filled container to record the highest temperature reached. Then, check its reading after the autoclave run is complete. If the temperature is too low, then the run-time will need to be increased or the volume will need to be reduced
6. To prevent bottles from getting shattered during pressurisation, the caps of the vessels with liquids must be loosened completely before loading

Safety during Autoclaving

Always follow the safety precautions to protect yourself and the equipment being used.

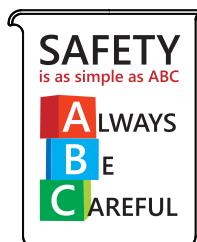

1. Be sure to wear the correct PPE including a lab coat, eye protection, closed-toe shoes, and heat-resistant gloves
2. Remember that after usage, glassware will be hot and can cause serious injury if the correct precautionary measures aren't taken
3. Always wait for the pressure gauge to drop to zero with zero time remaining before you open the door
4. Stand behind the door as you open it and allow all the steam to fully escape before reaching into the autoclave
5. Let glassware fully cool before touching them

DO'S	DON'T'S
Wait for 5 minutes before removing dry glassware from the autoclave, and wait for 10 to 20 minutes before removing glassware containing liquids	Do not tighten caps on the vessels immediately after autoclaving The cap or the vessel may get shattered due to the vacuum resulting from the cooling of the steam in the vessel
For non-liquid loads, please allow the glassware to cool for 15 minutes before touching it For liquid loads, please allow the liquid to stand for a full hour before touching the glassware	Do not put hot glassware, especially large bottles, from an autoclave (or any other heat source) on to a cold bench top. The stress that is induced will often cause the base of the vessel to crack or fall off, releasing its hot contents

PERSONAL SAFETY

- Use tongs or asbestos gloves to remove any glassware from heat. Hot glass can cause severe burns.
- Protective gloves, safety shoes, aprons and goggles should be worn to safeguard against chemical accidents, spilling or splattering.
- Always flush the outside of the acid bottle with water before opening it. Do not place the stopper on the counter top, where someone else may come in contact with acid residue.
- Care should be taken when handling mercury. Even a miniscule amount of mercury in the base of a drawer can poison the atmosphere in an entire room. Mercury toxicity is cumulative and the element's ability to amalgamate with a number of metals is well known. Following any accident involving mercury, the area should be checked thoroughly to ensure that there are no globules remaining. All mercury containers should be kept well stoppered.
- Never drink from a beaker. A beaker intended specifically for the use of drinking is a hazard in the laboratory. Do not taste chemicals to identify them. Smell chemicals only when necessary, and only by wafting a small amount of vapour towards the nose.
- Avoid using a Pipette with the mouth, particularly when using concentrated acids, alkalis or potentially biohazardous materials. Use mechanical means, such as a rubber bulb or an automatic dispenser.
- Do not fill the receptacle with any material other than that mentioned on the label. Label all containers before filling. Discard the contents of any unlabelled containers.
- To prevent breakage when clamping glassware, do not permit glass-to-metal contact, and do not use excessive force to tighten the clamps.
- Do not look down into a Test Tube being heated or containing chemicals, and do not point its open end at another person. A reaction could cause the contents to be ejected suddenly, resulting in injury.
- Splattering from acids, caustic materials and strong oxidising solutions on the skin or clothing should be washed off immediately with large quantities of water.
- When working with chlorine, hydrogen sulphide, carbon monoxide, hydrogen cyanide and other highly toxic substances, always use a protective mask. Alternatively, perform these experiments under a fume hood in a well ventilated area.
- In working with volatile materials, please keep in mind that heat causes expansion and confinement of such expansion results in explosion. Also remember that this danger exists even if external heat is not applied.
- Perchloric acid is particularly dangerous as it explodes when brought in contact with organic materials. Do not use perchloric acid around wooden benches or tables.
- Keep perchloric acid bottles on glass or ceramic trays with capacity that is adequate to hold all the acid in case the bottle breaks.
- When using perchloric acid, always wear protective clothing.
- When using hot plates and other electrical equipment, always ensure that the wire and plugs are in good condition. Do not handle an electrical connection with damp hands

A

APPARATUS

	Cat No.	Pg. No.
Arsenic determination apparatus As per USP	5200	115
Arsenic determination apparatus GUTZEIT	5201	115
Arsenic determination apparatus as per BP	5202	115
Arsenic determination apparatus as per IP	5203	116
Arsenic determination apparatus GUTZEIT as per IS	5204	116
Arsenic determination apparatus as per JP	5205	116
Arsenic determination apparatus as per EP	5206	117
Oxygen combustion as per USP	5210	117
Methoxy determination assembly as per USP	5211	117
Sulphur Di-oxide assembly as per USP	5212	118
Sodium Alginate Assembly as per USP	5215	118
Sodium Bicarbonate Assembly	5216	118
Lung Nitrometer	5217	118
R M Value Apparatus	3454	79
Dean Stark Distilling Apparatus	3602	79
Gas generator apparatus, KIPPS	6550	168

ADAPTERS

Adapters, Enlarging, Connecting 175	8800	
Adapters, Reduction, Connecting	8820	175
Adapters, Receiver Bent With Vaccum Connection	8830	175
Adapters, Multiple With Two Necks Parallel	8831	176
Adapters, Multiple With Two Necks - one vertical & one at 45°	8832	176
Adapters, Multiple with three Neck, Two Parallel & one at 45°	8833	176
Adapters, Swan Neck	8834	177
Adapters, Cone/ Rubber Tubing	8835	177
Adapters, Cone/ Flexible Tubing	8836	177
Adapters, Receiver, Straight socket to rubber	8837	178
Adapters, Receiver, Straight with Vacuum	8838	178
Adapters, Receiver, Bent with vent	8839	178
Adapter cones screw thread	8840	179
Slopping Plane still head	8841	179
Adapter receiver	8844	179
Adapter receiver, Plain bent	8845	180
Adapter recovery Bent with slopping end	8846	180
Adapter recovery Bent vertical	8847	180
Claisen head slopping	8849	181
Adapter receiver plain, vertical	8850	181
Splash head slopping pear shape	8852	182
Steam distillation heads	8853	182
Adapter straight cone with stopcock	8854	182
Adapter straight socket with stopcock	8855	183
Adapter bend cone with stopcock	8856	183
Adapter bend socket with stopcock	8857	183
Thermometer Pocket Long Type	8861	184
Thermometer Pocket Short Type	8862	184

B

BEAKERS

Beaker, Low form with spout	1000	27
Beaker, Tall form without spout	1040	27
Beaker, Tall form with spout	1060	28
Beaker, Phillips (Conical) with spout	1080	28

BOTTLES

Aspirator Bottles with GL 45 Cap and Tubulation	1220	31
Aspirator Bottles with GL 45 cap and socket	1240	31
Aspirator Bottles with GL 45 cap and I/C stopcock	1245	32
B.O.D. Bottles	1250	32
Roux Bottles	1290	32
Bottles, Reagent, narrow mouth, with I/C stopper	1500	33
Bottles, Reagent, narrow mouth, with screw cap	1501	33
Screw caps with pouring rings	1503	36
High temperature resistant screw caps	1505	36
Multiport HPLC Cap`	1513	36
Bottles, Reagent, wide mouth, Square	1506	37
Reagent Bottles	1507	37
Bottles, Reagent, narrow mouth, with I/C stopper, Amber	1509	38
Bottles, Reagent, narrow mouth, with screw cap, Amber	1519	38
Bottles, tooled neck, Solution bottle	1589	39
Bottle, relative density, with capillary, With Certificate	1624	40
Bottle, relative density, with capillary	1625	40
Bottle, Pyknometer, with thermometer and capillary side tube	1627	40
Bottles, weighing, with interchangeable lids	1630	41
Bottles, weighing, with interchangeable Amber	1631	41
Bottles, dropping with dropper and rubber teat	1640	41
Bottles dropping with pipette and rubber teat, Amber	1650	42
Bottles, wash, set with interchangeable stopper	1660	42
Bottles, stopper for wash bottles cat no. 1660	1661	42
Bottles, flasks for wash bottles cat no. 1660	1662	43
Bottles, wash, LDPE plastic bottles	166P	43
Bottles, plastic clamp for joint fittings	1665	43
Bottles, for gas washing	1760	44
Stopper for gas washing bottle, cat no. 1760	1761	44
Bottles, for gas washing bottle, cat no. 1760	1762	44
Gas sampling tubes	1764	45
Impinger	1765	45

BURETTES

Burettes with Boroflo stopcock, Class A	2121	48
Burettes with Boroflo stopcock, Class B	2122	48
Burettes With Glass stopcock, Class A	2123	49
Burettes With Glass stopcock, Class B	2124	49
Burettes With PTFE stopcock, Class A	2129	50
Burettes With PTFE stopcock, Class A	2130	50
Burettes with Boroflo stopcock, Class A, Amber	2131	51
Burettes with Boroflo stopcock, Class B, Amber	2132	51
Autoburettes with Glass stopcock, Class A	2149	52
Autoburettes with Glass stopcock, Class B	2150	52
Autoburettes with Glass stopcock, Class A, Amber	2149A	53
Autoburettes with Glass stopcock, Class B Amber	2150A	53
Autoburettes with PTFE stopcock, Class A	2153	54
Autoburettes with PTFE stopcock, Class B	2154	54

	Cat No.	Pg. No.		Cat No.	Pg. No.
BURETTES			DESICCATORS		
Autoburettes with PTFE stopcock, Class A, Amber	2153A	55	Desiccators with Cover and Porcelain Plate, Plastic Knob	3082	74
Autoburettes with Glass stopcock, Class A, Amber	2154A	55	Desiccators with Vacuum, Stopcock with PTFE		
Autoburettes with Boroflo stopcock, Class A	2155	56	Spindle, and Porcelain Plate	3083	74
Autoburettes with Boroflo stopcock, Class B	2156	56	Desiccators with Cover and Porcelain Plate, Plastic Knob, Amber	3084	75
Autoburettes with Boroflo stopcock, Class A, Amber	2155A	57	Desiccators with Vacuum stopcock with PTFE spindle and Porcelain plate, Amber	3085	75
Autoburettes with Boroflo stopcock, Class B, Amber	2156A	57			
C			DISHES		
CONES			Dishes, Crystallizing	3140	77
Cones, Imhoff, Sediment, Sharp Tip	2160	61	Dishes, Culture, Petri	3160	77
Cones, Imhoff, Sediment, Blunt Tip	2180	61	Dishes, Culture Petri, Borosil S-Line	3165	77
Cones, Imhoff, Sediment, Sharp Tip	6560	154	Trays, Drying Heavy Wall	3170	78
Cones, Imhoff, Sediment, Sharp Tip	6561	154	Dishes, Evaporating, Flat Bottom, With Pour Out	3180	78
CONDENSERS			DISTILLING APPARATUS		
Condensers, Liebig, with sealed Inner Tube	2340	63	Graham Condenser, I/C Joints	3340	81
Condensers, Liebig, Drip Tip	2400	63	Graham Condenser, I/C Joints and Stopper	3360	81
Condensers, Allihn, Drip Tip	2480	63	Friedrichs Condenser I/C joint and stopper Friedrichs	3380	81
Condensers, Graham, Coiled Drip Tip	2560	64	Condenser, Compact, I/C joint and stopper	3440	82
Condensers, Friedrichs, Drip Tip	2640	64	Essential Oil Determination Apparatus (Clevenger Apparatus, as per IS 1797 Essential Oil)	3450	82
Condensers, Double surface	2641	64	Determination Apparatus (Clevenger Apparatus)	3451	82
CHROMATOGRAPHY COLUMNS			Alcohol Distillation Unit	3452	83
Chromatography Column, Plain With Glass Stopcock	6100	148	R M Value Apparatus	3454	83
Chromatography Column, Plain With Sintered Disc and Glass Stopcock	6101	148	Dean Stark Distilling Apparatus	3602	83
CYLINDERS			E		
Condensers, Allihn, Drip Tip	2480	63	EXTRACTORS		
Condensers, Graham, Coiled Drip Tip	2560	64	Soxhlet for extraction with I/C joint Condensers,	3740	92
Condensers, Friedrichs, Drip Tip	2641	64	Allihn, for soxhlet extraction apparatus	3741	92
Nessler Cylinders	2975	68	Soxhlet extraction apparatus set	3840	93
Cylinders Class A, Hexagonal Base, with I/C Stopper	2981	68	F		
Cylinders Class B, Hexagonal Base, with I/C Stopper	2982	69	FLASKS		
Cylinders USP, Class A, Hexagonal Base, with I/C Stopper	2983	69	Flask, Flat bottom, narrow mouth	4060	97
Cylinders Class A, Hexagonal base, Pour out	3021	70	Flask, Flat bottom, narrow mouth, short neck with I/C joint	4100	97
Cylinders Class B, Hexagonal base, Pour out	3022	70	Flask, Round bottom, narrow mouth	4260	98
Cylinders ASTM Class A, Hexagonal base, Pour out	3026	71	Dissolution E- Flask, USP, Clear	4265	97
Cylinders ASTM Class B, Hexagonal base, Pour out	3027	71	Dissolution D- Flask	4270	97
Cylinders, Tapped Density Cylinder As Per USP, Ch. 616, set of two	3032	72	Flask Pear Shape with I/C joint	4315	98
Cylinders, Tapped Density Cylinder As Per USP, Ch. 616, 100ml	3033	72	Flask Rotary Evaporator with I/C joint	4320	98
Cylinders, Tapped Density Cylinder As Per USP, Ch. 616, 250ml	3034	73	Flask Reaction vessel	4330	98
Crow Cylinder	3041	73	Lid for Reaction vessel flask	4331	99
			Flask, Round bottom, narrow mouth short neck with I/C joint	4380	99
			Flask, Round bottom, 2 necks, angular	4381	100
			Flask, Round bottom, 2 necks, parallel	4382	101

	Cat No.	Pg. No.
Flask, Round bottom, 3 necks, angular	4383	104
Flask, Round bottom, 3 necks, parallel	4384	105
Flask, Round bottom, 4 necks, angular	4385	106
Flask, Round bottom, 4 necks, parallel	4386	107
Flask, Culture, Haffkine	4422	107
Flask, Distilling with side arm	4620	108
Flask, Distilling with I/C stopper	4621	108
Flask, Conical Erlenmeyer, Narrow Mouth with Rim	4980	108
Flask, Conical Erlenmeyer, Long Neck without Rim	4981	109
Flask, Conical Erlenmeyer, without Rim	4981	109
Flask, Conical Erlenmeyer, Narrow Mouth with Rim, Amber	4989	109
Flask, Conical Erlenmeyer, Narrow Mouth with Tilt measure	5000	110
	5015	110
Flask, Conical Erlenmeyer, Narrow Mouth with I/C Joint and Stopper, Amber	5019	110
Flask, Conical Erlenmeyer, Narrow Mouth with I/C Joint and Stopper	5020	111
Flask, Conical Erlenmeyer, with screw cap	5021	111
Flask Conical Erlenmeyer, with screw cap, Baffled bottom	5025	111
Flask, Conical Erlenmeyer, Wide mouth Filter	5100	112
Flask with glass tubulation	5340	112
Flask Iodine flask with I/C glass stopper	5400	112
Kjeldahl Flask	5420	113
Kjeldahl Flask with I/C Joint	5430	113

FILTRATION PRODUCTS

Glass Filtration Assembly, 47mm	5350	123
Glass Filtration Assembly, 90mm	5350	123
Glass Filtration Assembly, With silicone stopper, 47mm	5360	124
Glass Filtration Assembly, With silicone stopper, 25mm	5370	125
Glass Filtration Assembly with bottle, 47mm	5380	126
Glass Filtration Assembly with bottle, 90mm	5380	126
Glass Filtration Assembly with GL 45 Universal adapter, 47 mm	5385	127
SS Filter Assembly with inbuilt clamp 47 mm	5330	129
SS Filter Assembly with external clamp 47 mm	5331	129
SS Filter Funnel with spin lock type, 47 mm	5332	130
SS Vacuum Filtration Manifold	5333	130
Vacuum Filtration Pump	5334	131
Filtration Assembly with inbuilt pump	5335	131
Filter membrane, Cellulose Nitrate	5147	133
Filter membrane, Gridded Cellulose Nitrate	5247	133
Filter membrane, Nylon-66	5347	133

Filter Papers

Qualitative Filter Papers	228-230
Ashless Quantitative	232-234
Hardened Ashless	236-237
Glass Fiber	238-239
Thimbles	240-241

FUNNELS

Filter Funnel, Glass, Short Stem	6140	151
Funnel test tube	6150	151
Powder Funnel	6220	151
Powder Funnel, Stem, with cone	6230	151
Separating, Globe Shape, with Stopcock and I/C Stopper	6340	152
Separating, Pear Shape, with Stopcock and I/C Stopper	6400	152
Separating, Pear Shape, with Boroflo Stopcock and I/C Stopper	6402	152
Separating, Pear Shape, with PTFE Stopcock and I/C Stopper	6403	153
Pressure equilising cylindrical with PTFE stopcock	6405	153
Dropping funnel	6408	153

K

KETTLES

Reaction Kettle Assembly	6947	157
Bottoms, only for Kettles Cat. No. 6947	6948	157
Covers, only for Kettles Cat. No. 6947	6949	157

L

LAB ACCESSORIES

Tongs for Beakers & Flasks	219
Tongs for Crucible	219
Clamps	219
Clamps with Bosshead	220
Universal Clamps	220
Burette Clamps	220
Bossheads	221
Retort Ring	221
Retort Base	221
Rod for Retort Base	222
Test Tube Stand	222
Test Tube Holder	222
Burners	222
Spatulas	223
Forceps Pointed	224
Forceps PTFE Pointed	224
Forceps Blunt Dissecting	224
Forceps PTFE Blunt	224
Wire Gauge	224
Triangular Tripod	224

LABQUEST

LABORATORY EQUIPMENTS

Magnus Kjeldahl Block Digesters	244
Oracle Kjeldahl Block Digesters	245
Fume Scrubber	247
Magnus Distillation System with Autotitrator	248
Magnus Kjeldahl Distillation System	249
Oracle Kjeldahl Distillation System	250
Classical Kjeldahl Distillation unit	252

	Cat No.	Pg. No.
Alcohol distillation unit with Chiller		253
Fat Determination Apparatus : Soxhlet Extraction		254
Rapid Fat Analyser		256
Moisture Analyser		257
Quanta -UV Visible Spectrophotometer		258
COD Digestion Unit		263
Thermoreactor		264
Water Baths	265-268	
Data Logger		269
On Demand Single Distillation Unit		270
On Demand Double Distillation Unit		271
On Demand All Quartz Distillation Unit		272
Quartz Cabinet Distillation (QCD)		273
Mono Quartz Distillation Unit		274
All Quartz Double Distillation Unit		275
Overhead Stirrer		277
Impeller		278
Magnetic Stirrers - Heat & Stir Applications		278
Stands / Clamps / Chuck		279
Magnetic Stirrers - Stir only applications		280
Hot Plate Stirrer		281
Industrial Max Stir MGS series		282
Magnetic Stirrers with Heating - Multiple position		283
Magnetic Stirrers - Stir only applications		284
Rectangular Hot Plates		285
Aluminium Heating Blocks		286
Temperature Controlled Heating Mantles		287
Multi position Heating Mantles		288
Precision Stirring & Heating Mantles		289
Mini Lab Reactor	290-291	
Cooling & Heating Circulators		292
Vacuum Pump - BORO 017		293
Chemical Resistance vacuum pump		294
Glass Dryer		295
Micro Centrifuge	296-298	
Cooling High Speed Micro Centrifuge		299
Clinical Centrifuge	300-304	
Universal Lab Centrifuge	305-306	
High Speed Universal Lab Centrifuge		307
Cooling Universal Lab Centrifuge		308
Dry Baths		309
Incubator		310
Shaker	311-314	
Vortexer	315-317	
Bottle Top Dispenser		318
e-Titrate		319
e-Dispenser		320
Micropipettes	321-326	

M

MANSINGH SURVISMETER	3453	90-91
MICROSCOPE SLIDES & COVERS GLASS		
Microscope Slides	9100	205
Cover Glass	9115	205
MORTAR AND PESTLE	7210	170
MUSEUM JARS	6910	156

NABL CERTIFIED GLASSWARE

N

NABL CERTIFIED GLASSWARE

Burettes with Boroflo stopcock, Class A, NABL Certified	2000	58
Burettes with Boroflo stopcock, Class A, Amber, NABL Certified	2001	58
Burettes With Glass stopcock, Class A, NABL Certified	2002	58
Cylinders Class A, Hexagonal base, Pour out, NABL Certified	2010	73
Volumetric Flask, Class A, NABL Certified	2020	145
Volumetric Flask, Class A, Amber, NABL Certified	2021	146
Pipette, Mohr, Class A, NABL Certified	2030	168
Pipette, volumetric, Class A, NABL Certified	2040	168

P

PIPETTES

Artificial Insemination Pipette	7040	160
Drum Sampling	7041	160
Bacteriological/Milk Pipette	7056	161
Gerber, Milk Pipettes	7057	161
Gerber, Milk Pipettes With Certificate	7058	162
Mohr Piepttes, Class A	7060	162
Mohr Piepttes, Class B	7062	163
Mohr Piepttes, Class B, White Marking	7079	163
Serological Pipettes, Class A	7080	164
Volumetric Pipette, Class A	7081	164
Volumetric Pipette, Class A, ASTM	7082	165
Volumetric Pipette, Class A, ASTM	7100	165
Volumetric Pipette, Class A, ASTM	7101	166
Volumetric Pipette, Class B	7102	166
Volumetric Pipette, Class B, ASTM	7103	167
Volumetric Pipette, Class A, ASTM, Amber	7106	167

PREMIUM MICRO PIPETTE TIPS

328-331

PROCESS SYSTEMS

Mini Lab Reactor	334-335
Block Based Reaction System	336-337
Mini Compact Lab Reactor	338-339
Compact Lab Reactor	340-341
Bench Lab Reactor	344-345
Floor Lab Reactor MIDI	346-347
Floor Lab Reactor MIDI PILOT	348-349
Scrubber	350-351
Reactor Accessories	352-357
Turnkey Projects	358
Vacuum & Liquid Transfer Pumps - KNF	359
Agitator Drive -IKA & Heldolph	359
Heating & Cooling Circulator - Huber	360
Chiller	361



A BOROSIL SCIENTIFIC Company

Industrial Scientific Process Glass Equipments, Components & Spares

362-369

Q Cat No. Pg. No.

QUARTZWARE

Quartz Beakers, low form with spout	1002	199
Quartz Petri Dishes	3164	199
Quartz Muffle trays	3175	199
Quartz Dishes / Basins round with spout	3185	200
Quartz Comustion Boat with handle	3186	200
Quartz Crucibles without lid	3190	200
Quartz Lids for crucibles	3191	201
Quartz Volatile matter crucibles	3195, 3196, 3197	201
Quartz Silica triangles on Nichrome	3198	201
Quartz Conical flasks	4984	201
Quartz Volumetric Flasks	5644	202
Quartz Circular Capsule	8600	202

QUARTZWARE

Quartz Reagent Bottle, with hollow stopper	1511	202
Quartz Measuring cylinder w/spout class B,	3028	203
Quartz Funnel, 75mm	6141	203
Quartz Pipette measuring Mohr type,	7064	203
Quartz Pipette, Transfer, Volumetric, Class B	7104	203

S

STOPPERS

Stoppers, Glass, Penny head, ISO/DIN, Clear	8100	146, 173
Stoppers, Glass, Penny head, ASTM, Clear	8110	146, 173
Stoppers, Polypropylene (PP) Stoppers	8300	147, 173
Stoppers, Glass, Penny head, ISO/DIN, Amber	8400	147, 174
Stoppers, Glass, Penny head, ASTM, Amber	8410	147, 174

SINTERED WARE

Buchner Funnel With Sintered Disc	36060	208
Gooch Crucible Low Form, With Sintered Disc	32060	209
Tube for Gooch Crucible	32061	209

SOCKETS

Sockets, Plain shank, Single	6580	167
Sockets, Plain shank, Double	6581	155

STIRRER ROD

Stirrer Rod, Glass	9850	168
Stirrer Rod, Glass, With PTFE Blade	9860	167

SPREADER

9865 202

SAMPLING AND STORAGE VIALS

9913 204

T

TUBES

Blood Sugar, Folin- Wu, Tube	7840	171
Tube Centrifuge, Plain	8060	171
Tube Centrifuge, Graduated	8080	171
Tube Centrifuge, Graduated with I/C Stopper	8084	172
Tube Centrifuge, Graduated, PP Screw Cap	8090	172
Tube Centrifuge, Heavy Duty, with Spout, Plain, Short conical bottom	8320	174
Tube Centrifuge, Heavy Duty, with Spout, Graduated, Short conical bottom	8340	174

TUBES

Tube for Culture collection	9801	198
Tube, Culture, Round Bottom, Clear, with PP Cap	9900	203
Tube, Culture, Round Bottom, Amber, with PP Cap	9901	203
Tube, Culture, Flat Bottom, Clear, with PP Cap	9910	203
Tube, Culture, Flat Bottom, Amber, with PP Cap	9911	204

TEST TUBES

Test Tube, With Rim	9800	186
Tube for culture collection	9801	186
Test Tube, Without Rim	9820	187
Test Tube, Flat bottom, Without Rim	9821	187
Test Tube, Flat bottom, With Rim	9822	188
Test Tube, Plain, With I/C Stopper	9829	188
Test Tube, Graduated, With I/C Stopper	9830	188
Test Tube, Graduated, With I/C Stopper, Amber	9831	189
COD Digestion Tube	9835	189

V

VISCOMETER

Viscometer college pattern	3500	91
----------------------------	------	----

VOLUMETRIC FLASKS

Volumetric Flask, Class A, Narrow mouth, Clear	5640	138
Volumetric Flask, Class B, Narrow mouth, Clear	5641	138
Volumetric Flask, Class A, Wide mouth, Clear	5643	139
Volumetric Flask, ASTM, Narrow mouth, Clear	5645	139
Volumetric Flask, USP, Class A, Narrow mouth, Clear	5645D	140
Volumetric Flask, ASTM, Wide mouth, Clear	5647	140
Volumetric Flask, USP, Class A, Wide mouth, Clear	5647D	141
Volumetric Flask, Class A, Narrow mouth, Amber	5648	141
Volumetric Flask, Class B, Narrow mouth, Amber	5649	142
Volumetric Flask, Sugar Estimation	5650	142
Volumetric Flask, Class A, Wide mouth, Amber	5653	143
Volumetric Flask, ASTM, Narrow mouth, Amber	5655	143
Volumetric Flask, USP, Class A, Narrow mouth, Amber	5655D	144
Volumetric Flask, ASTM, Wide mouth, Amber	5657	144
Volumetric Flask, USP, Class A, Wide mouth, Amber	5657D	145

VIALS & CLOSURES

2 ml HPLC Sample Vials & Closures	209
2 ml HPLC Sample Vials & Closures	210-211
49 Expansion glass vial with silicone white / PTFE red septa	
2 ml HPLC Sample Vials & Closures	212-213
33 Expansion glass vial with silicone white / PTFE red septa	
HPLC Inlet Filters	214
20 ml GC Headspace Vials & Closures	215
40 ml EPA/TOC Combipack	216

W

WATER DISTILLATION UNITS

On Demand Single Distillation Unit	85,270
On Demand Double Distillation Unit	86,271
On Demand All Quartz Distillation Unit	272
Quartz Cabinet Distillation	87,273
Mono Quartz Distillation Unit	88,274
All Quartz Double Distillation Unit	89,275

WEIGHING SCOOP	7200	170
-----------------------	------	-----

WATCH GLASS	9986	193
--------------------	------	-----

TECHNICAL INFORMATION	362-368
------------------------------	---------

Caution Notice

We, **BOROSIL SCIENTIFIC LIMITED** a company registered under the Companies Act, 1956 and having its registered office at 1101, Crescenzo, G-Block, Opp. MCA Club, Bandra Kurla Complex, Bandra (East), Mumbai - 400 051, Maharashtra, India are the licensee of Trademark BOROSIL , which is a registered mark. Pursuant to NCLT (Mumbai Bench) order dated 2 Nov 2023, sanctioning a Composite Scheme of Arrangement (Scheme), effective since 2 Dec 2023, the Scientific and Industrial Products business of Borosil Limited has been demerged into **BOROSIL SCIENTIFIC LIMITED** and **BOROSIL SCIENTIFIC LIMITED** is entitled to the Trademark **BOROSIL[®]** as a licensee.

The said, trademark **BOROSIL[®]** has been used in the market, to sell and export a wide variety of glassware products since more than 5(five) decades throughout India as well as several countries across the globe.

The Trademark **BOROSIL[®]** has acquired a very high reputation and goodwill by virtue of long, extensive and continuous use. The said trademark is associated and identified with the Scientific and Industrial Products which are manufactured, marketed and sold by BOROSIL SCIENTIFIC LIMITED pursuant to the Scheme.

It has, from time to time come to our notice that some persons occasionally try to sell spurious goods by copying the trademark and/or 'Borosil Logo' **BOROSIL[®]**

The trade and public are cautioned that only products manufactured, marketed and sold by **BOROSIL SCIENTIFIC LIMITED** are permitted to carry the trademark or **BOROSIL[®]**

Those who are deceiving the public by copying the Trademark or **BOROSIL[®]** or using it wrongly on products not made, marketed and /or sold by will be prosecuted and we will adopt all legal recourse available, which may be Civil or Criminal in nature and may include police raids, to prevent such unauthorized use without giving further notice.

The Trade and Public are cautioned that they should always request for a bill on purchase of their products, as spurious goods are harmful and have dangerous and adverse effects to the life of the user as well as the nation.

We request you to bring to our attention any instances of such nefarious activities, which you may come across, we shall maintain the secrecy of your identity.

Correspondence in this connection may please be made at the registered office address of the Company.



BOROSIL® Scientific

Borosil Scientific Limited

CIN : U74999MH1991PLC061851

Registered & Corporate Office :

1101, Crescenzo, G-Block, Opp. MCA Club, Bandra Kurla Complex,
Bandra (E), Mumbai - 400 051, India.

T +91 22 6740 6300 ● F +91 22 6740 6514
E bsl@borosil.com ● W www.borosilscientific.com

Write to us for export enquiries at bsl.exports@borosil.com

MUMBAI

B-306, Kanakia Zillion,
L.B.S. Marg, Kurla (West),
Mumbai - 400 070

mumbaisales@borosil.com

+91 22 6740 6400
+91 22 6740 6444

DELHI

1213 Vijaya Building 17
Barakhamba Road
New Delhi - 110001

delhi@borosil.com

+91 11 4150 5893

CHENNAI

No 7, 3rd Floor,
Golden Perch,
No. 3 Wheat Crofts Road,
Nungambakkam,
Chennai - 600 034

chennai@borosil.com

+91 44 2822 6012 / 13
+91 44 2822 6014

KOLKATA

E-2/3 Gillander House,
2nd Floor, FL- E- 2/3,
8 Netaji Subhas Road,
Kolkata- 700001

calcutta@borosil.com

+91 33 2229 9166